

MAIN BOARD	11AK37
SHEET	006/SMPs
VERSION	8
DATE	29.05.2002

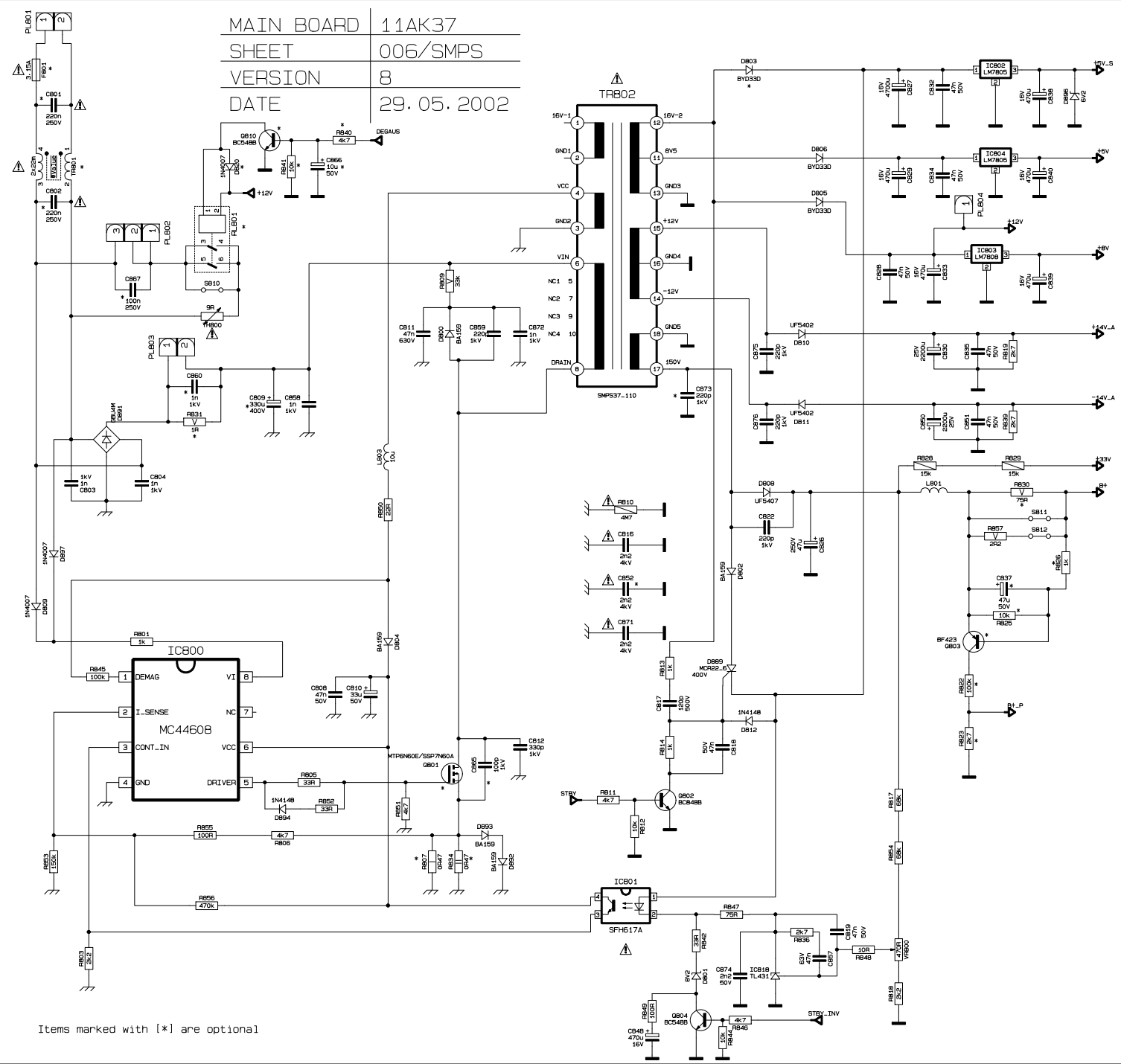

Items marked with [*] are optional