

# SUP500R

---

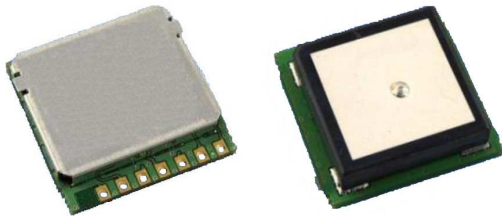

## Features

- 65 Channel GPS L1 C/A Code
- Perform 8 million time-frequency hypothesis testing per second
- Open sky hot start 1 sec
- Open sky cold start 29 sec
- Signal detection better than -161dBm
- Multipath detection and suppression
- Accuracy 2.5m CEP
- Maximum update rate 10Hz
- Tracking current ~28mA

## Applications

- PND
- MID / Netbook
- Smart-Phone
- Geo-Tagging
- Automatic Vehicle Location
- Personal Tracking

## SUP500R ROM-based

### Low-Power High-Performance Low-Cost 65 Channel GPS Smart Antenna Module

The SUP500R is a compact all-in-one GPS receiver module solution intended for a broad range of Original Equipment Manufacturer (OEM) products, where fast and easy system integration and minimal development risk is required.

The SUP500R GPS receiver's -161dBm tracking sensitivity allows continuous position coverage in nearly all application environments. Its high performance search engine is capable of testing 8,000,000 time-frequency hypotheses per second, offering industry-leading signal acquisition and TTFF speed.

The receiver is optimized for applications requiring high performance, low power, and low cost; suitable for a wide range of OEM configurations including mobile phone, PND, asset tracking, and vehicle navigation products.

The compact 22mm x 22mm form factor allows it to be used in many applications. Its on-board antenna connector allows external connection of active antenna. Switching to external antenna is automatic when external antenna is applied.

---

## TECHNICAL SPECIFICATIONS

Receiver Type	L1 C/A code, 65-channel Venus 6 engine
Accuracy	Position 2.5m CEP Velocity 0.1m/sec Time 300ns
Startup Time	1 second hot start under open sky 29 second cold start under open sky (average)
Reacquisition	1s
Sensitivity	-161dBm tracking
Multi-path Mitigation	Advanced multi-path detection and suppression
Update Rate	Supports 1 / 2 / 4 / 5 / 8 / 10 Hz update rate (1Hz default)
Dynamics	4G (39.2m/sec <sup>2</sup> )
Operational Limits	Altitude < 18,000m and velocity < 515m/s
Serial Interface	3V LVTTTL level
Protocol	NMEA-0183 V3.01 GPGGA, GPGLL, GPGSA, GPGSV, GPRMC, GPVTG <sup>*1</sup> 9600 baud, 8, N, 1
Datum	Default WGS-84 User definable
Input Voltage	3.0V ~ 5.5V DC
Input Current	~28mA tracking
Dimension	22mm L x 22mm W
Weight:	9g
Operating Temperature	-40°C ~ +85°C
Storage Temperature	-55 ~ +100°C
Humidity	5% ~ 95%

\*1: GPGGA, GPGSA, GPGSV, GPRMC, GPVTG are default output message

---

## BLOCK DIAGRAM

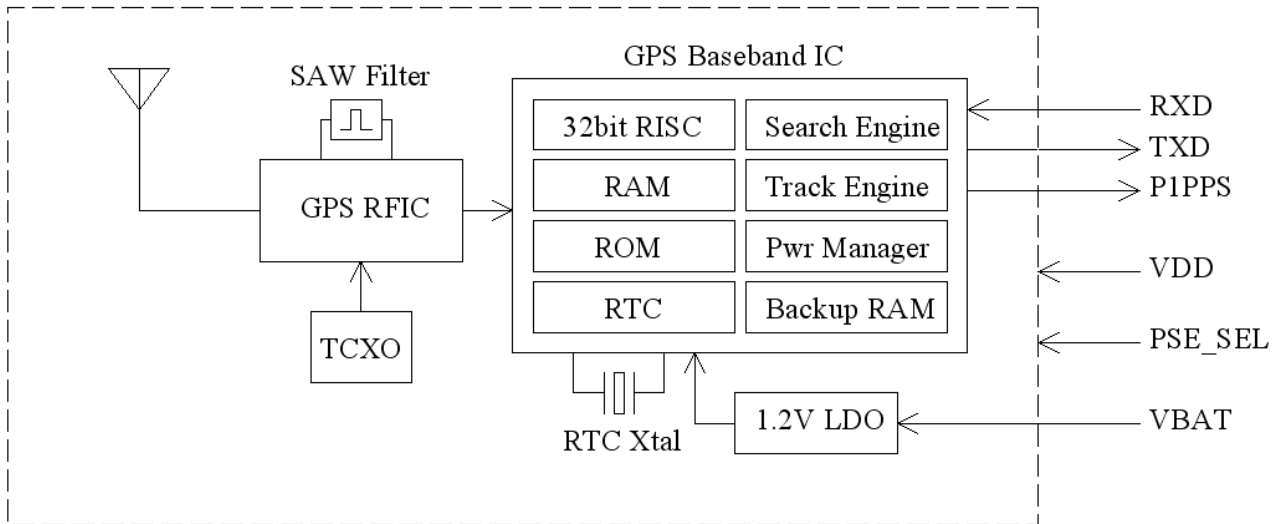

**Module block schematic**

## MODULE OPTIONS

SUP500R options	On-board backup battery	On-board RS232 driver	Note
SUP500R	No	No	Standard module, lowest price, LVTTTL UART
SUP500RB	Yes	No	On-board backup battery, LVTTTL UART
SUP500RR	Yes	Yes	On-board backup battery, RS232 interface

## PIN CONNECTION DESCRIPTION

Pin No.	Name	Description
1	RXD	UART input, 3V LVTTTL for SUP500R, SUP500RB UART input, RS232 level for SUP500RR
2	TXD	UART output, 3V LVTTTL for SUP500R, SUP500RB UART output, RS232 level for SUP500RR
3	GND	System ground
4	VDD	Main 3.0V ~ 5.5V supply input
5	VBAT	Backup supply voltage for RTC and SRAM, 1.5V ~ 5.5V for SUP500R No need to connect for SUP500RB, SUP500RR
6	P1PS	1 pulse per second time mark output
7	PSE_SEL	Search Engine Mode select 1: Low power acquisition mode (default), acquisition current ~50mA 0: Enhanced acquisition mode, acquisition current ~70mA

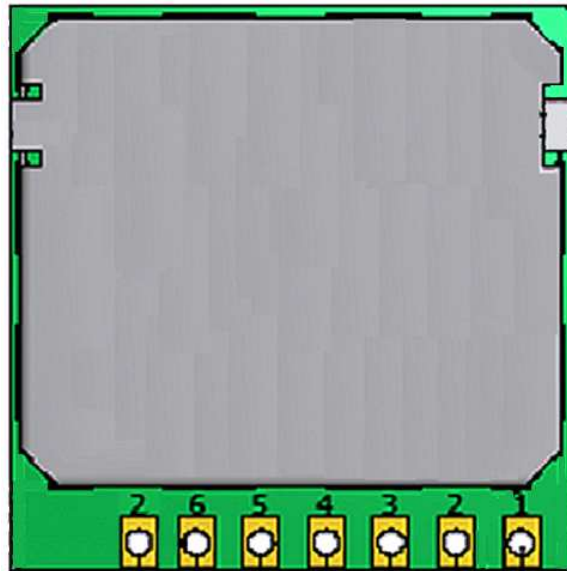

# MECHANICAL DIMENSIONS

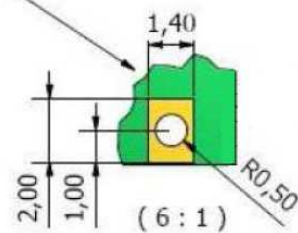
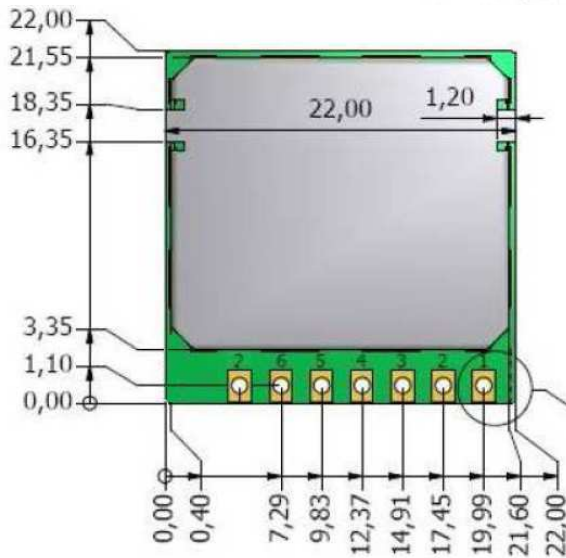
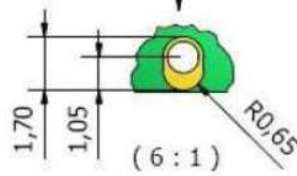
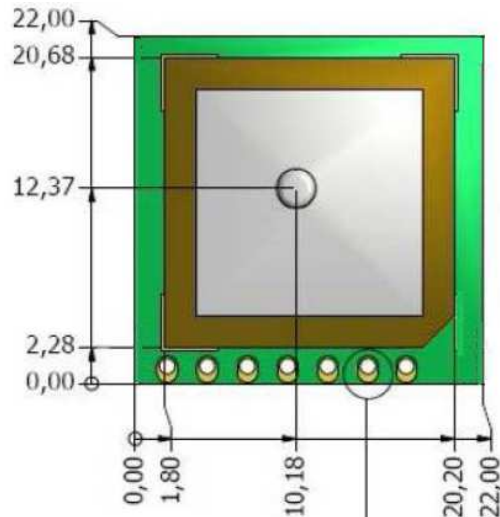
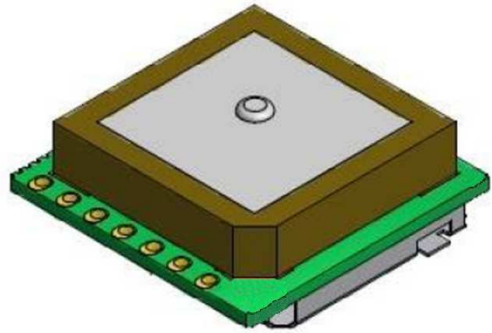
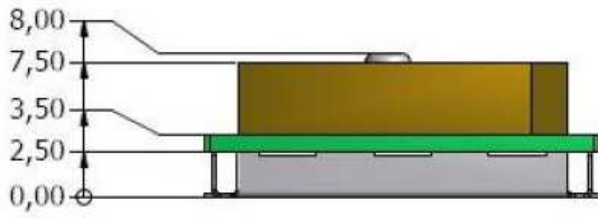

## PCB MOUNTING

The SUP500R can be mounted on the application PCB using standard 2.54mm pitch 1x6 pin header. Two dummy soldering pads on the RF shield are used to fix the module to the application PCB.

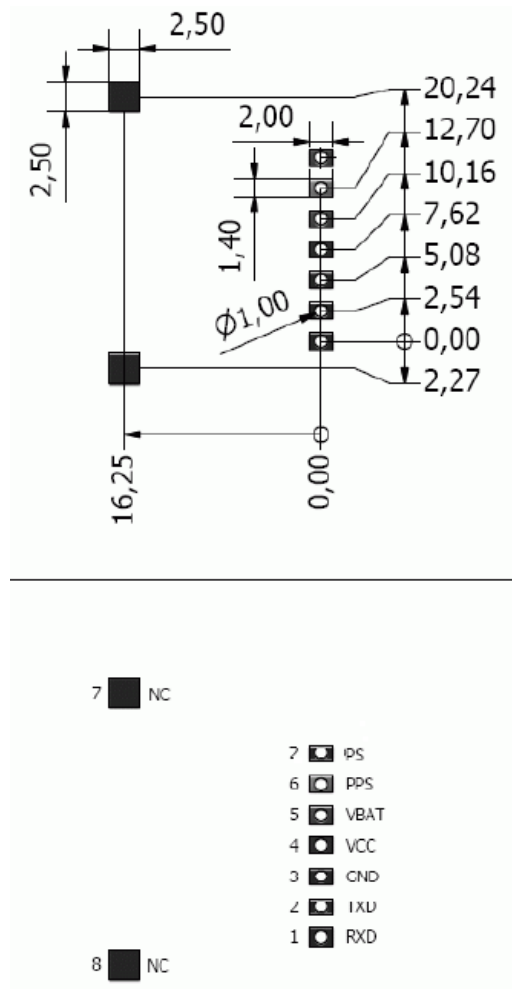

## NMEA MESSAGES

The full descriptions of supported NMEA messages are provided at the following paragraphs.

### **GGA - Global Positioning System Fix Data**

Time, position and fix related data for a GPS receiver.

Structure:

```
$GPGGA,hhmmss.sss,ddmm.mmmm,a,dddmm.mmmm,a,x,xx,x.x,x.x,M,,,,,xxx*hh<CR><LF>
```

1
2
3
4
5 6 7 8 9
10 11

Example:

```
$GPGGA,111636.932,2447.0949,N,12100.5223,E,1,11,0.8,118.2,M,,,,,0000*02<CR><LF>
```

Field	Name	Example	Description
1	UTC Time	111636.932	UTC of position in hhmmss.sss format, (000000.000 ~ 235959.999)
2	Latitude	2447.0949	Latitude in ddm.dddmm format Leading zeros transmitted
3	N/S Indicator	N	Latitude hemisphere indicator, 'N' = North, 'S' = South
4	Longitude	12100.5223	Longitude in dddmm.mmmm format Leading zeros transmitted
5	E/W Indicator	E	Longitude hemisphere indicator, 'E' = East, 'W' = West
6	GPS quality indicator	1	GPS quality indicator 0: position fix unavailable 1: valid position fix, SPS mode 2: valid position fix, differential GPS mode 3: GPS PPS Mode, fix valid 4: Real Time Kinematic. System used in RTK mode with fixed integers 5: Float RTK. Satellite system used in RTK mode. Floating integers 6: Estimated (dead reckoning) Mode 7: Manual Input Mode 8: Simulator Mode
7	Satellites Used	11	Number of satellites in use, (00 ~ 12)
8	HDOP	0.8	Horizontal dilution of precision, (00.0 ~ 99.9)
9	Altitude	108.2	mean sea level (geoid), (-9999.9 ~ 17999.9)
10	DGPS Station ID	0000	Differential reference station ID, 0000 ~ 1023 NULL when DGPS not used
11	Checksum	02	

### GLL – Latitude/Longitude

Latitude and longitude of current position, time, and status.

Structure:

\$GPGLL,ddmm.mmmm,a,dddmm.mmmm,a,hhmmss.sss,A,a\*hh<CR><LF>  
                  1      2      3      4      5      6 7 8

Example:

\$GPGLL,2447.0944,N,12100.5213,E,112609.932,A,A\*57<CR><LF>

Field	Name	Example	Description
1	Latitude	2447.0944	Latitude in ddmm.mmmm format Leading zeros transmitted
2	N/S Indicator	N	Latitude hemisphere indicator 'N' = North 'S' = South
3	Longitude	12100.5213	Longitude in dddmm.mmmm format Leading zeros transmitted
4	E/W Indicator	E	Longitude hemisphere indicator 'E' = East 'W' = West
5	UTC Time	112609.932	UTC time in hhmmss.sss format (000000.000 ~ 235959.999)
6	Status	A	Status, 'A' = Data valid, 'V' = Data not valid
7	Mode Indicator	A	Mode indicator 'N' = Data not valid 'A' = Autonomous mode 'D' = Differential mode 'E' = Estimated (dead reckoning) mode 'M' = Manual input mode 'S' = Simulator mode
8	Checksum	57	



**GSA – GNSS DOP and Active Satellites**

GPS receiver operating mode, satellites used in the navigation solution reported by the GGA or GNS sentence and DOP values.

Structure:

```
$GPGSA,A,x,xx,xx,xx,xx,xx,xx,xx,xx,xx,xx,xx,xx,x.x,x.x,x.x*hh<CR><LF>
  1 2 3 3 3 3 3 3 3 3 3 3 3 3 4 5 6 7
```

Example:

```
$GPGSA,A,3,05,12,21,22,30,09,18,06,14,01,31,,1.2,0.8,0.9*36<CR><LF>
```

Field	Name	Example	Description
1	Mode	A	Mode 'M' = Manual, forced to operate in 2D or 3D mode 'A' = Automatic, allowed to automatically switch 2D/3D
2	Mode	3	Fix type 1 = Fix not available 2 = 2D 3 = 3D
3	Satellite used 1~12	05,12,21,22,30,09,18,06,14,01,31,,	Satellite ID number, 01 to 32, of satellite used in solution, up to 12 transmitted
4	PDOP	1.2	Position dilution of precision (00.0 to 99.9)
5	HDOP	0.8	Horizontal dilution of precision (00.0 to 99.9)
6	VDOP	0.9	Vertical dilution of precision (00.0 to 99.9)
7	Checksum	36	

**GSV – GNSS Satellites in View**

Number of satellites (SV) in view, satellite ID numbers, elevation, azimuth, and SNR value. Four satellites maximum per transmission.

Structure:

```
$GPGSV,x,x,xx,xx,xx,xxx,xx,...,xx,xx,xxx,xx *hh<CR><LF>  
  1 2 3 4 5 6 7 4 5 6 7 8
```

Example:

```
$GPGSV,3,1,12,05,54,069,45,12,44,061,44,21,07,184,46,22,78,289,47*72<CR><LF>  
$GPGSV,3,2,12,30,65,118,45,09,12,047,37,18,62,157,47,06,08,144,45*7C<CR><LF>  
$GPGSV,3,3,12,14,39,330,42,01,06,299,38,31,30,256,44,32,36,320,47*7B<CR><LF>
```

Field	Name	Example	Description
1	Number of message	3	Total number of GSV messages to be transmitted (1-3)
2	Sequence number	1	Sequence number of current GSV message
3	Satellites in view	12	Total number of satellites in view (00 ~ 12)
4	Satellite ID	05	Satellite ID number, GPS: 01 ~ 32, SBAS: 33 ~ 64 (33 = PRN120)
5	Elevation	54	Satellite elevation in degrees, (00 ~ 90)
6	Azimuth	069	Satellite azimuth angle in degrees, (000 ~ 359 )
7	SNR	45	C/No in dB (00 ~ 99) Null when not tracking
8	Checksum	72	

**RMC – Recommended Minimum Specific GNSS Data**

Time, date, position, course and speed data provided by a GNSS navigation receiver.

Structure:

```
$GPRMC,hhmmss.sss,A,dddmm.mmmm,a,dddmm.mmmm,a,x.x,x.x,ddmmyy,,,a*hh<CR><LF>
```

1    2    3    4    5    6 7 8    9    10 11

Example:

```
$GPRMC,111636.932,A,2447.0949,N,12100.5223,E,000.0,000.0,030407,,,A*61<CR><LF>
```

Field	Name	Example	Description
1	UTC time	0111636.932	UTC time in hhmmss.sss format (000000.00 ~ 235959.999)
2	Status	A	Status 'V' = Navigation receiver warning 'A' = Data Valid
3	Latitude	2447.0949	Latitude in dddmm.mmmm format Leading zeros transmitted
4	N/S indicator	N	Latitude hemisphere indicator 'N' = North 'S' = South
5	Longitude	12100.5223	Longitude in dddmm.mmmm format Leading zeros transmitted
6	E/W Indicator	E	Longitude hemisphere indicator 'E' = East 'W' = West
7	Speed over ground	000.0	Speed over ground in knots (000.0 ~ 999.9)
8	Course over ground	000.0	Course over ground in degrees (000.0 ~ 359.9)
9	UTC Date	030407	UTC date of position fix, ddmmyy format
10	Mode indicator	A	Mode indicator 'N' = Data not valid 'A' = Autonomous mode 'D' = Differential mode 'E' = Estimated (dead reckoning) mode 'M' = Manual input mode 'S' = Simulator mode
11	checksum	61	

**VTG – Course Over Ground and Ground Speed**

The Actual course and speed relative to the ground.

Structure:

GPVTG,x.x,T,,M,x.x,N,x.x,K,a\*hh<CR><LF>  
1 2 3 4 5

Example:

\$GPVTG, 000.0,T,,M,000.0,N,0000.0,K,A\*3D<CR><LF>

Field	Name	Example	Description
1	Course	000.0	True course over ground in degrees (000.0 ~ 359.9)
2	Speed	000.0	Speed over ground in knots (000.0 ~ 999.9)
3	Speed	0000.0	Speed over ground in kilometers per hour (0000.0 ~ 1800.0)
4	Mode	A	Mode indicator 'N' = not valid 'A' = Autonomous mode 'D' = Differential mode 'E' = Estimated (dead reckoning) mode 'M' = Manual input mode 'S' = Simulator mode
5	Checksum	3D	

## ORDERING INFORMATION

<b>Model Name</b>	<b>Description</b>
SUP500R	ROM Version GPS Smart Antenna Module, No Backup Battery, LVTTL UART
SUP500RB	ROM Version GPS Smart Antenna Module, With Backup Battery, LVTTL UART
SUP500RR	ROM Version GPS Smart Antenna Module, With Backup Battery, RS232

The information provided is believed to be accurate and reliable. These materials are provided to customers and may be used for informational purposes only. No responsibility is assumed for errors or omissions in these materials, or for its use. Changes to specification can occur at any time without notice.

These materials are provided "as is" without warranty of any kind, either expressed or implied, relating to sale and/or use including liability or warranties relating to fitness for a particular purpose, consequential or incidental damages, merchantability, or infringement of any patent, copyright or other intellectual property right. No warrant on the accuracy or completeness of the information, text, graphics or other items contained within these materials. No liability assumed for any special, indirect, incidental, or consequential damages, including without limitation, lost revenues or lost profits, which may result from the use of these materials.

The product is not intended for use in medical, life-support devices, or applications involving potential risk of death, personal injury, or severe property damage in case of failure of the product.

---