

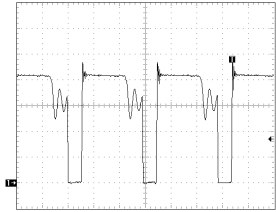
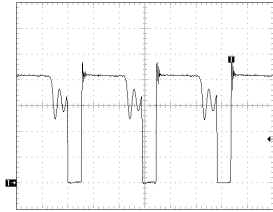

**1** 100 V (IC601, #1)

CH1 P-P = 100 V CH1 RMS = 350.2 V

**2** 100V (IC601, #1)

CH1 P-P = 100V CH1 RMS = 325.8 V

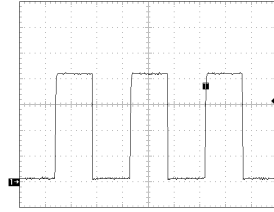
**3** 2.00 V (IC401, #28)

CH1 P-P = 2.00V CH1 RMS = 5.868V

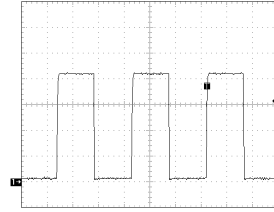
**4** 2.00V (IC401, #26)

CH1 P-P = 2.00V CH1 RMS = 5.868V

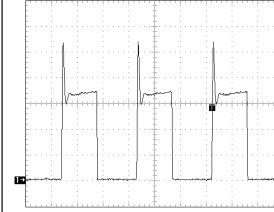
**5** 20.0 V (Q403, Collector)

CH1 P-P = 20.0 V CH1 RMS = 46.80V

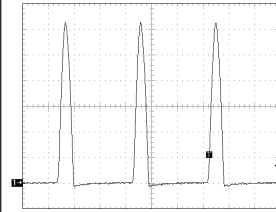
**6** 200 V (Q404, Collector)

CH1 P-P = 200V CH1 RMS = 387.2V

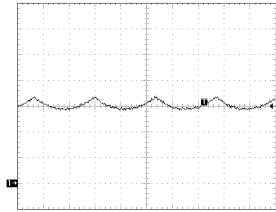
**7** 1.00 V (IC401, #24)

CH1 P-P = 1.00V CH1 RMS = 3.008 V

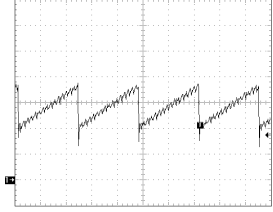
**8** 500 V (IC401, #23)

CH1 P-P = 500 V CH1 RMS = 1.425 V

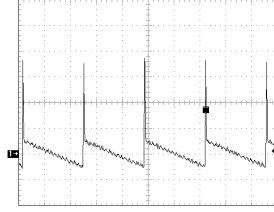
**9** 10.0 V (IC301, #6)

CH1 P-P = 10.0 V CH1 RMS = 5.06 V

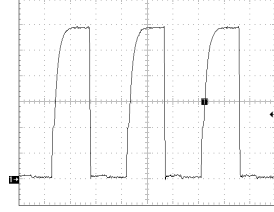
**10** 2.00 V (Q402, Gate)

CH1 P-P = 2.00 V CH1 RMS = 7.692V

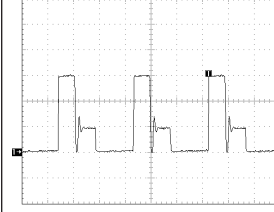
**11** 50.0 V (Q402, Drain)

CH1 P-P = 50.0 V CH1 RMS = 73.7V

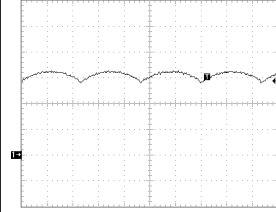
**12** 2.00 V (IC401, #32)

CH1 P-P = 2.00V CH1 RMS = 6.124V

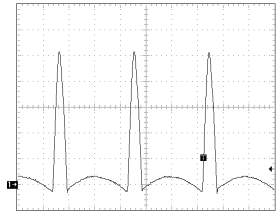
**13** 50.0 V (T502, #5)

CH1 P-P = 50.0V CH1 RMS = 75.6V

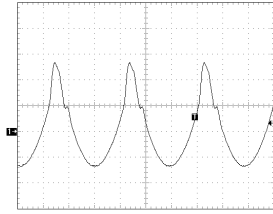
**14** 100 V (T502, #1)

CH1 P-P = 100V CH1 RMS = 124.0V

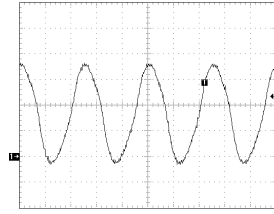
**18** 1.00 V (IC201, #13, 14)

CH1 P-P = 1.00 V CH1 RMS = 2.108V

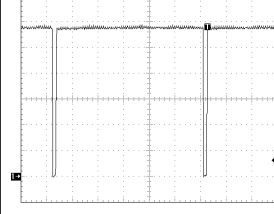
**23** 5.00V (Q303, Collector)

CH1 P-P = 5.00V CH1 RMS = 28.33V

# 11-1-2 PU17KS\* Video Part Schematic Diagram

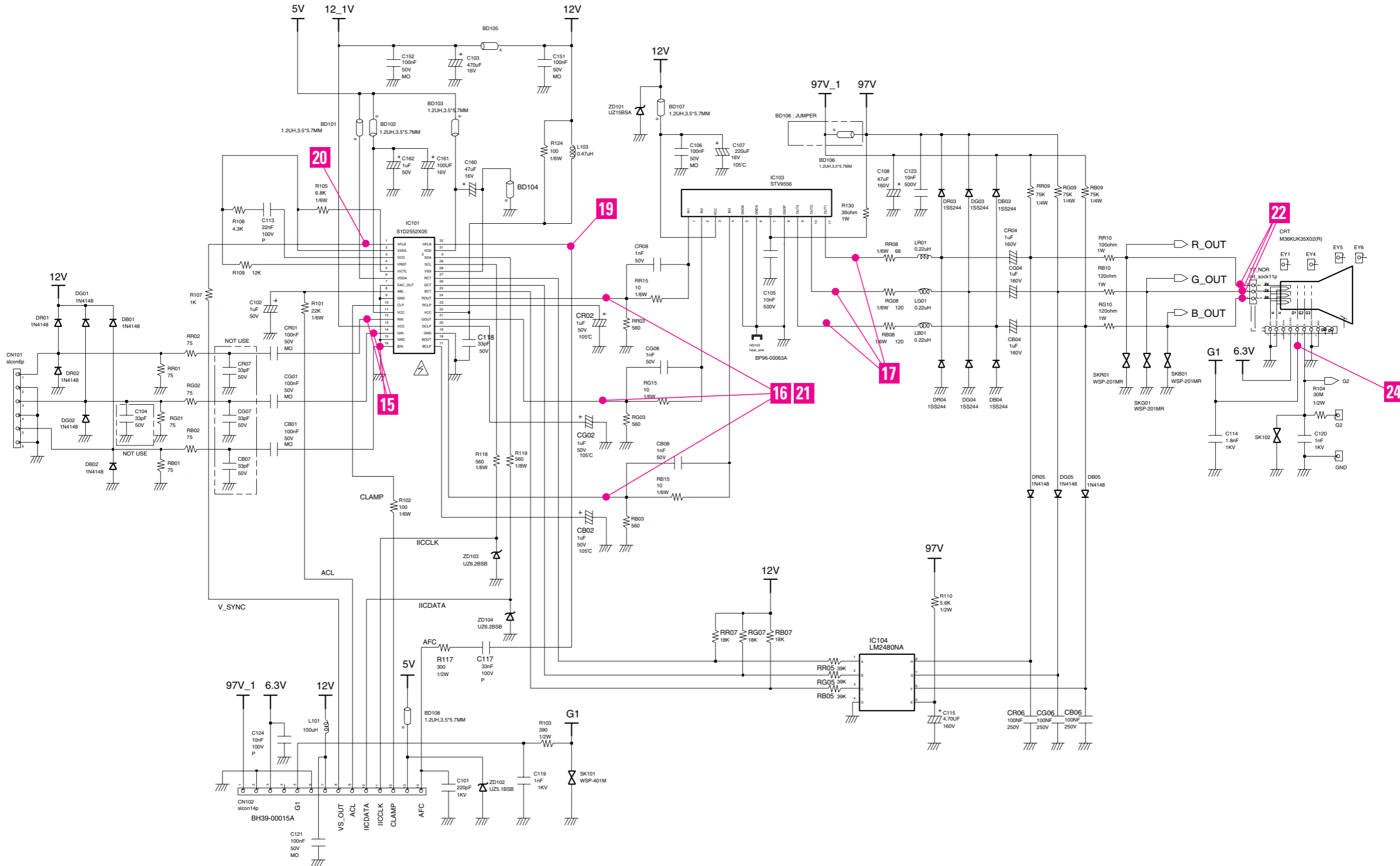

**15** 1.00V (IC101 #12,14,16)

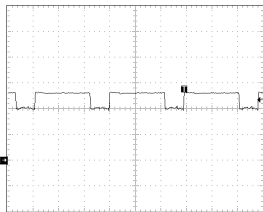

CH1 P-P = 1.00V CH1 RMS = 2.452V

**16** 1.00V (IC101 #18,21,24)

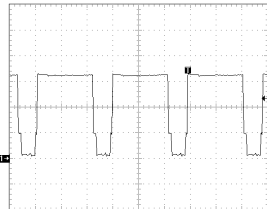

CH1 P-P = 1.00V CH1 RMS = 2.792V

**17** 20.0V (IC103, #9, 10, 11)

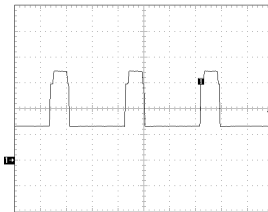

CH1 P-P = 20.0V CH1 RMS = 40.52V

**19** 1.00 V (IC101, #32)

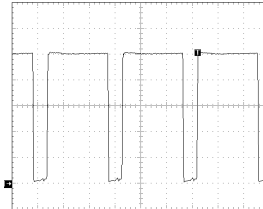

CH1 P-P = 1.00V CH1 RMS = 4.516V

**20** 1.00 V (IC101, #1)

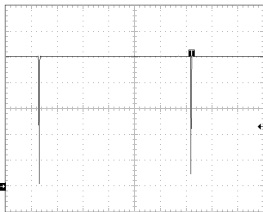

CH1 P-P = 1.00V CH1 RMS = 5.024V

**21** 1.00 V (IC101, #18,21,24)

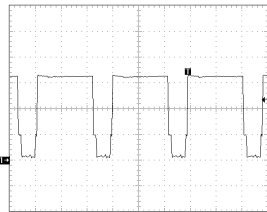

CH1 P-P = 1.00V CH1 RMS = 2.580V

**22** 10.0 V (R,G,B, Video)

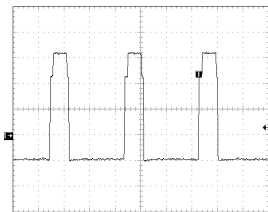

CH1 P-P = 10.0V CH1 RMS = 17.02V

**24** 20.00V (CRT Socket, G1)

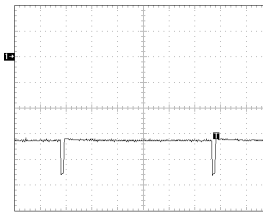

CH1 P-P = 20.0V CH1 RMS = 66.68V

# 11-2-1 PU17JS\* Main Part Schematic Diagram

## SCHEMATIC DIAGRAM

CHASSIS NO: PERSEUS  
MODEL NO: PU17JS

**CAUTION**

1. THE SHADED AREAS AND - MARKED IN THE SCHEMATIC DIAGRAM AND THE PARTS LIST DESIGNATE COMPONENTS WHICH HAVE SPECIAL CHARACTERISTICS IMPORTANT FOR SAFETY AND SHOULD BE REPLACED ONLY WITH TYPES IDENTICAL TO THOSE IN THE ORIGINAL CATALOG OR SPECIFIED IN THE PARTS LIST. BEFORE REPLACING ANY OF THESE COMPONENTS, PLEASE CONSULT THE "PRODUCT SAFETY NOTICE".

2. DURING A NUMEROUS MEASUREMENT OF THIS EQUIPMENT, YOU SHOULD TAKE EXTREME CARE TO AVOID THE FOLLOWING: 1. DO NOT USE YOUR INSTRUMENT BETWEEN PRIMARY CIRCUIT AND SECONDARY CIRCUIT. 2. DO NOT USE YOUR INSTRUMENT BETWEEN SECONDARY CIRCUIT AND SECONDARY CIRCUIT.

**WARNING:**

THIS EQUIPMENT CONTAINS SAFETY CRITICAL COMPONENTS ALL PARTS SAFETY CRITICAL COMPONENTS MUST BE REPLACED BY SAFETY CRITICAL COMPONENTS. CRITICAL COMPONENTS IDENTICAL TO THOSE IN THE ORIGINAL CATALOG OR SPECIFIED IN THE PARTS LIST. BEFORE REPLACING ANY OF THESE COMPONENTS, PLEASE CONSULT THE "PRODUCT SAFETY NOTICE".

**NOTE**

1. RESISTANCE IS SHOWN IN OHM K Ω 1000 Ω 100 Ω. CAPACITANCE IS SHOWN IN PFD AND NOT IN THE ORIGINAL CATALOG OR SPECIFIED IN THE PARTS LIST. BEFORE REPLACING ANY OF THESE COMPONENTS, PLEASE CONSULT THE "PRODUCT SAFETY NOTICE".

**AVERTISSEMENT:**

CE RECEPTIF CONTIEN DES COMPOSANTS CRITIQUES POUR LA SECURITE. TOUS LES PIECES CRITIQUES POUR LA SECURITE DOIVENT ETRE REMPLACÉES PAR DES PIECES IDENTIQUES À CELLES DU CATALOGUE ORIGINAL OU INDICÉES DANS LA LISTE DES PIECES. AVANT DE REMPLACER N'IMPORTE QUELLE DES CES PIECES, VOUZ DEVEZ CONSULTER LE MANUEL D'INSTRUCTIONS ET LE DOCUMENT "NOTICE DE SECURITE DU PRODUIT".

**REMARKS:**

1. THE SHADING AREAS IN THIS SCHEMATIC DIAGRAM AND THE PARTS LIST INDICATE THE PARTS WHICH HAVE SPECIAL CHARACTERISTICS IMPORTANT FOR SAFETY AND SHOULD BE REPLACED ONLY WITH TYPES IDENTICAL TO THOSE IN THE ORIGINAL CATALOG OR SPECIFIED IN THE PARTS LIST. BEFORE REPLACING ANY OF THESE COMPONENTS, PLEASE CONSULT THE "PRODUCT SAFETY NOTICE".

**REMARKS:**

1. THE SHADING AREAS IN THIS SCHEMATIC DIAGRAM AND THE PARTS LIST INDICATE THE PARTS WHICH HAVE SPECIAL CHARACTERISTICS IMPORTANT FOR SAFETY AND SHOULD BE REPLACED ONLY WITH TYPES IDENTICAL TO THOSE IN THE ORIGINAL CATALOG OR SPECIFIED IN THE PARTS LIST. BEFORE REPLACING ANY OF THESE COMPONENTS, PLEASE CONSULT THE "PRODUCT SAFETY NOTICE".

**REMARKS:**

1. THE SHADING AREAS IN THIS SCHEMATIC DIAGRAM AND THE PARTS LIST INDICATE THE PARTS WHICH HAVE SPECIAL CHARACTERISTICS IMPORTANT FOR SAFETY AND SHOULD BE REPLACED ONLY WITH TYPES IDENTICAL TO THOSE IN THE ORIGINAL CATALOG OR SPECIFIED IN THE PARTS LIST. BEFORE REPLACING ANY OF THESE COMPONENTS, PLEASE CONSULT THE "PRODUCT SAFETY NOTICE".

**REMARKS:**

1. THE SHADING AREAS IN THIS SCHEMATIC DIAGRAM AND THE PARTS LIST INDICATE THE PARTS WHICH HAVE SPECIAL CHARACTERISTICS IMPORTANT FOR SAFETY AND SHOULD BE REPLACED ONLY WITH TYPES IDENTICAL TO THOSE IN THE ORIGINAL CATALOG OR SPECIFIED IN THE PARTS LIST. BEFORE REPLACING ANY OF THESE COMPONENTS, PLEASE CONSULT THE "PRODUCT SAFETY NOTICE".

**REMARKS:**

1. THE SHADING AREAS IN THIS SCHEMATIC DIAGRAM AND THE PARTS LIST INDICATE THE PARTS WHICH HAVE SPECIAL CHARACTERISTICS IMPORTANT FOR SAFETY AND SHOULD BE REPLACED ONLY WITH TYPES IDENTICAL TO THOSE IN THE ORIGINAL CATALOG OR SPECIFIED IN THE PARTS LIST. BEFORE REPLACING ANY OF THESE COMPONENTS, PLEASE CONSULT THE "PRODUCT SAFETY NOTICE".

**REMARKS:**

1. THE SHADING AREAS IN THIS SCHEMATIC DIAGRAM AND THE PARTS LIST INDICATE THE PARTS WHICH HAVE SPECIAL CHARACTERISTICS IMPORTANT FOR SAFETY AND SHOULD BE REPLACED ONLY WITH TYPES IDENTICAL TO THOSE IN THE ORIGINAL CATALOG OR SPECIFIED IN THE PARTS LIST. BEFORE REPLACING ANY OF THESE COMPONENTS, PLEASE CONSULT THE "PRODUCT SAFETY NOTICE".

**REMARKS:**

1. THE SHADING AREAS IN THIS SCHEMATIC DIAGRAM AND THE PARTS LIST INDICATE THE PARTS WHICH HAVE SPECIAL CHARACTERISTICS IMPORTANT FOR SAFETY AND SHOULD BE REPLACED ONLY WITH TYPES IDENTICAL TO THOSE IN THE ORIGINAL CATALOG OR SPECIFIED IN THE PARTS LIST. BEFORE REPLACING ANY OF THESE COMPONENTS, PLEASE CONSULT THE "PRODUCT SAFETY NOTICE".

**REMARKS:**

1. THE SHADING AREAS IN THIS SCHEMATIC DIAGRAM AND THE PARTS LIST INDICATE THE PARTS WHICH HAVE SPECIAL CHARACTERISTICS IMPORTANT FOR SAFETY AND SHOULD BE REPLACED ONLY WITH TYPES IDENTICAL TO THOSE IN THE ORIGINAL CATALOG OR SPECIFIED IN THE PARTS LIST. BEFORE REPLACING ANY OF THESE COMPONENTS, PLEASE CONSULT THE "PRODUCT SAFETY NOTICE".

**REMARKS:**

1. THE SHADING AREAS IN THIS SCHEMATIC DIAGRAM AND THE PARTS LIST INDICATE THE PARTS WHICH HAVE SPECIAL CHARACTERISTICS IMPORTANT FOR SAFETY AND SHOULD BE REPLACED ONLY WITH TYPES IDENTICAL TO THOSE IN THE ORIGINAL CATALOG OR SPECIFIED IN THE PARTS LIST. BEFORE REPLACING ANY OF THESE COMPONENTS, PLEASE CONSULT THE "PRODUCT SAFETY NOTICE".

**REMARKS:**

1. THE SHADING AREAS IN THIS SCHEMATIC DIAGRAM AND THE PARTS LIST INDICATE THE PARTS WHICH HAVE SPECIAL CHARACTERISTICS IMPORTANT FOR SAFETY AND SHOULD BE REPLACED ONLY WITH TYPES IDENTICAL TO THOSE IN THE ORIGINAL CATALOG OR SPECIFIED IN THE PARTS LIST. BEFORE REPLACING ANY OF THESE COMPONENTS, PLEASE CONSULT THE "PRODUCT SAFETY NOTICE".

**REMARKS:**

1. THE SHADING AREAS IN THIS SCHEMATIC DIAGRAM AND THE PARTS LIST INDICATE THE PARTS WHICH HAVE SPECIAL CHARACTERISTICS IMPORTANT FOR SAFETY AND SHOULD BE REPLACED ONLY WITH TYPES IDENTICAL TO THOSE IN THE ORIGINAL CATALOG OR SPECIFIED IN THE PARTS LIST. BEFORE REPLACING ANY OF THESE COMPONENTS, PLEASE CONSULT THE "PRODUCT SAFETY NOTICE".

**REMARKS:**

1. THE SHADING AREAS IN THIS SCHEMATIC DIAGRAM AND THE PARTS LIST INDICATE THE PARTS WHICH HAVE SPECIAL CHARACTERISTICS IMPORTANT FOR SAFETY AND SHOULD BE REPLACED ONLY WITH TYPES IDENTICAL TO THOSE IN THE ORIGINAL CATALOG OR SPECIFIED IN THE PARTS LIST. BEFORE REPLACING ANY OF THESE COMPONENTS, PLEASE CONSULT THE "PRODUCT SAFETY NOTICE".

**REMARKS:**

1. THE SHADING AREAS IN THIS SCHEMATIC DIAGRAM AND THE PARTS LIST INDICATE THE PARTS WHICH HAVE SPECIAL CHARACTERISTICS IMPORTANT FOR SAFETY AND SHOULD BE REPLACED ONLY WITH TYPES IDENTICAL TO THOSE IN THE ORIGINAL CATALOG OR SPECIFIED IN THE PARTS LIST. BEFORE REPLACING ANY OF THESE COMPONENTS, PLEASE CONSULT THE "PRODUCT SAFETY NOTICE".

**REMARKS:**

1. THE SHADING AREAS IN THIS SCHEMATIC DIAGRAM AND THE PARTS LIST INDICATE THE PARTS WHICH HAVE SPECIAL CHARACTERISTICS IMPORTANT FOR SAFETY AND SHOULD BE REPLACED ONLY WITH TYPES IDENTICAL TO THOSE IN THE ORIGINAL CATALOG OR SPECIFIED IN THE PARTS LIST. BEFORE REPLACING ANY OF THESE COMPONENTS, PLEASE CONSULT THE "PRODUCT SAFETY NOTICE".

**REMARKS:**

1. THE SHADING AREAS IN THIS SCHEMATIC DIAGRAM AND THE PARTS LIST INDICATE THE PARTS WHICH HAVE SPECIAL CHARACTERISTICS IMPORTANT FOR SAFETY AND SHOULD BE REPLACED ONLY WITH TYPES IDENTICAL TO THOSE IN THE ORIGINAL CATALOG OR SPECIFIED IN THE PARTS LIST. BEFORE REPLACING ANY OF THESE COMPONENTS, PLEASE CONSULT THE "PRODUCT SAFETY NOTICE".

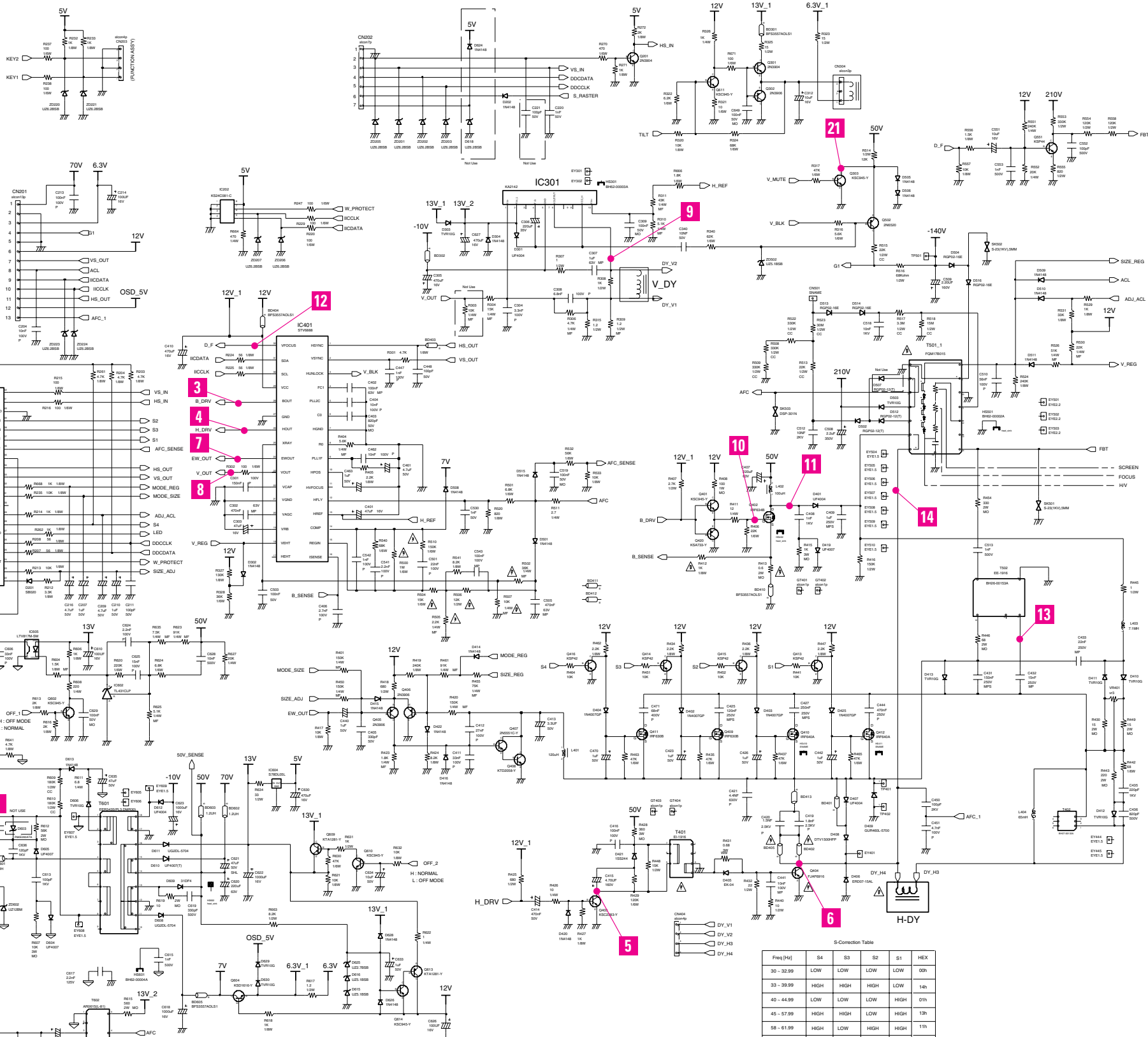

S-Correction Table

Freq [Hz]	S4	S3	S2	S1	HEX
30 - 32.99	LOW	LOW	LOW	LOW	00h
33 - 39.99	HIGH	HIGH	HIGH	LOW	16h
40 - 44.99	LOW	LOW	LOW	HIGH	01h
45 - 57.99	HIGH	HIGH	LOW	HIGH	13h
58 - 61.99	HIGH	LOW	HIGH	HIGH	17h
62 - 69.99	LOW	HIGH	HIGH	HIGH	07h
70 - 84.99	HIGH	HIGH	HIGH	HIGH	15h

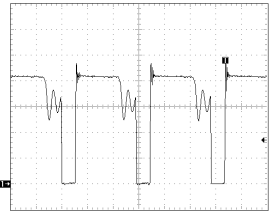
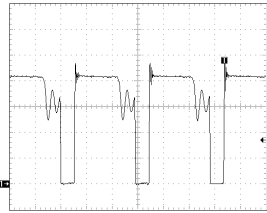
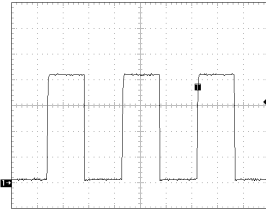
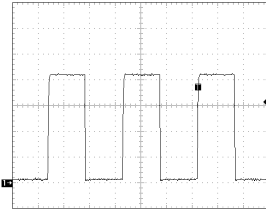
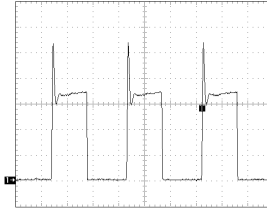
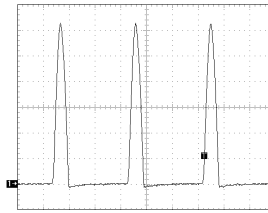
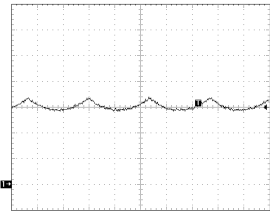
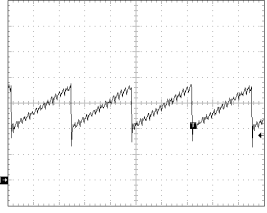
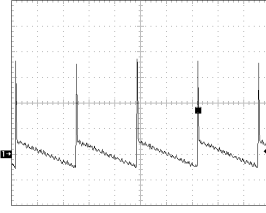
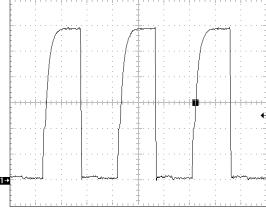
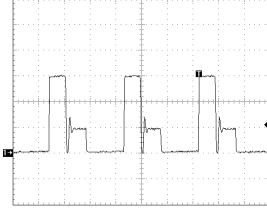
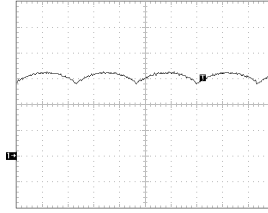
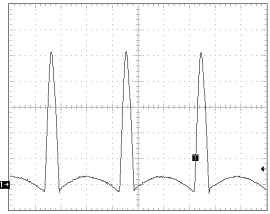
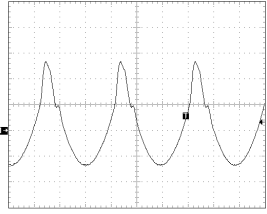
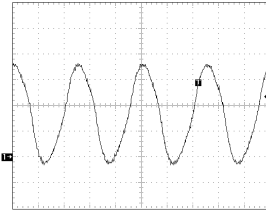
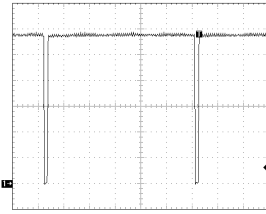
**1** 100 V (IC601, #1)**2** 100V (IC601, #1)**3** 2.00 V (IC401, #28)**4** 2.00V (IC401, #26)**5** 20.0 V (Q403, Collector)**6** 200 V (Q404, Collector)**7** 1.00 V (IC401, #24)**8** 500 V (IC401, #23)**9** 10.0 V (IC301, #6)**10** 2.00 V (Q402, Gate)**11** 50.0 V (Q402, Drain)**12** 2.00 V (IC401, #32)**13** 50.0 V (T502, #5)**14** 100 V (T502, #1)**18** 1.00 V (IC201, #8, 9)**21** 5.00V (Q303, Collector)

\* This Document can not be used without Samsung's authorization.

# 11-2-1 PU17JS\* Video Part Schematic Diagram

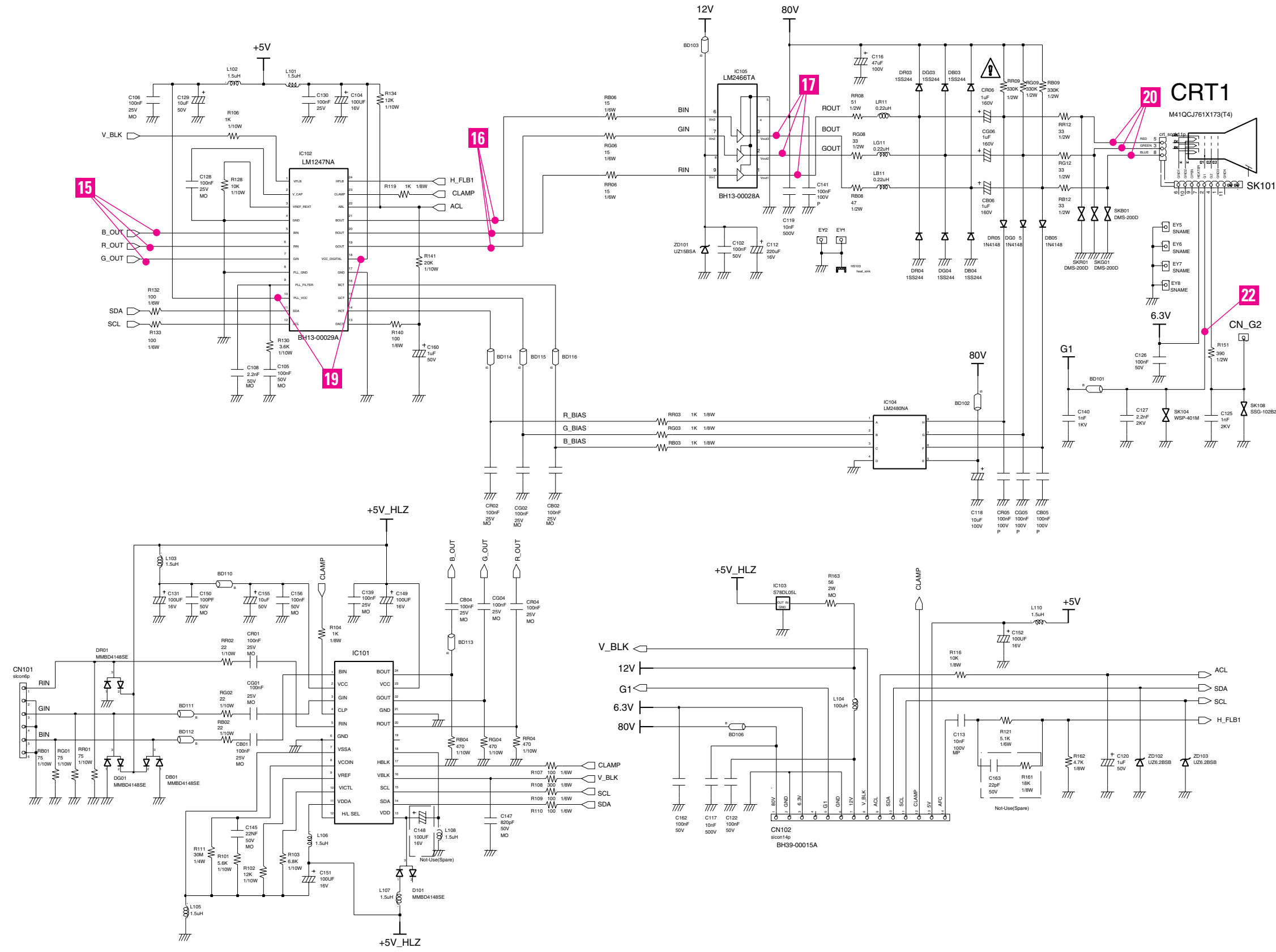

**15** 1.00 V (IC102,#5, 6, 7)

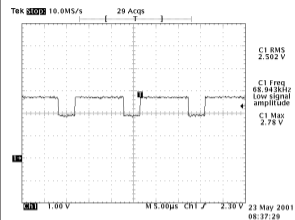

**16** 1.00 V (IC102, #19,20,21)

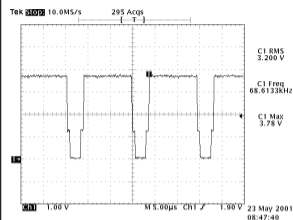

**17** 20.0 V (IC105, #1, 2, 3)

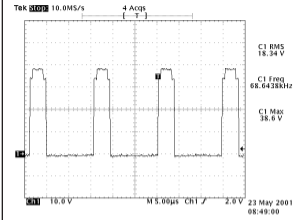

**19** 1.00 V (IC102, #10, 18)

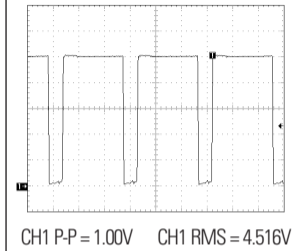

**20** 10.0 V (R,G,B, Video)

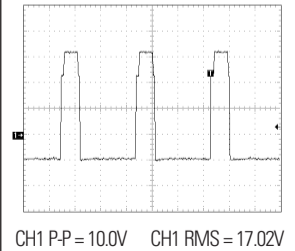

**22** 20.00V (CRT Socket, G1)

