

Ferrite for Switching Power Supplies

Summary

Issue date: February 2010

- All specifications are subject to change without notice.
 - Conformity to RoHS Directive: This means that, in conformity with EU Directive 2002/95/EC, lead, cadmium, mercury, hexavalent chromium, and specific bromine-based flame retardants, PBB and PBDE, have not been used, except for exempted applications.
-

Ferrite for Switching Power Supplies

Summary

Our foremost mission is to develop unique and advanced electronics technologies. As such, ever since TDK was founded in 1935 when its researchers invented ferrite, we have been involved in a wide range of technological and product development efforts.

Particularly, our high-performance ferrite elements, which result from our accumulated expertise and excellent microstructure control technologies, have become essential in reducing the weight and improving the performance of advanced electronic devices that are transforming the world around us.

As a result of pursuing the numerous potentials of these ferrite elements, we have been able to develop high-frequency power ferrite material that deliver among the world's highest levels of reliability and magnetic properties. These products include PC40, PC44 and PC47. They contribute to achieving even greater size reductions and performance improvements of high-performance switching power supplies and DC to DC converters -- products considered to constitute the heart of microelectronic devices. We have also developed the PC95, which delivers a saturated magnetic flux density equivalent to that of PC44 and low loss in a wide temperature range. This materials is expected to improve the efficiency of power supplies in DC to DC converters used in electric vehicles. Additionally, we have been conducting research in ferrite that delivers permeability close to the theoretical limit in high frequency ranges. These ferrite materials are designed for EMC solutions. The materials HS52, HS72, HS10 and HS12 deliver frequency responses with excellent permeability - a prerequisite for EMC magnetic material such as EMI filters and common mode choke coils - and higher impedance compared to existing material in the high frequency ranges.

In parallel with material development, we have been working to reduce sizes and improve the performance of our switching power supplies and DC to DC converters. To this end, we have been developing optimum core shape designs and creating an extensive line up of these products to accommodate a wide range of specific needs.

CIRCUIT EXAMPLE

SINGLE FORWARD CONVERTER

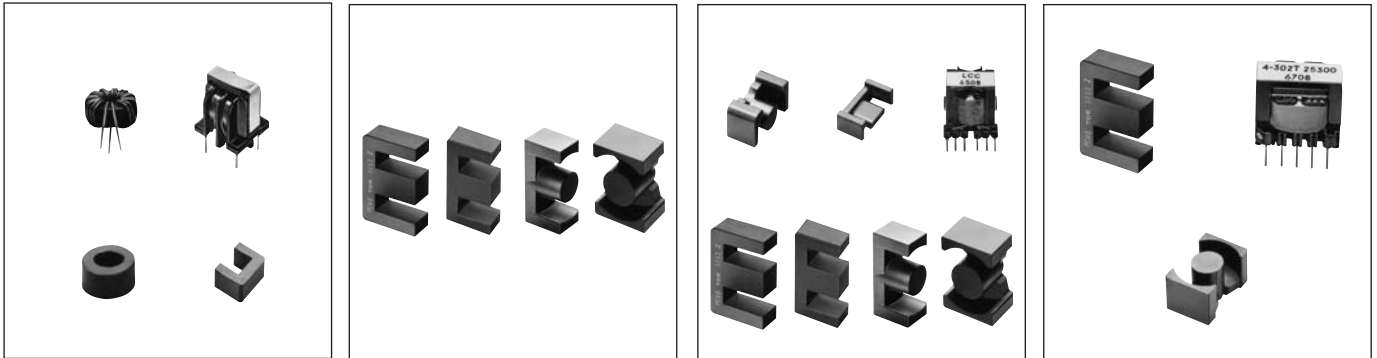

Common mode choke coil

Active filter choke coil

Main power transformer

Smoothing choke coil

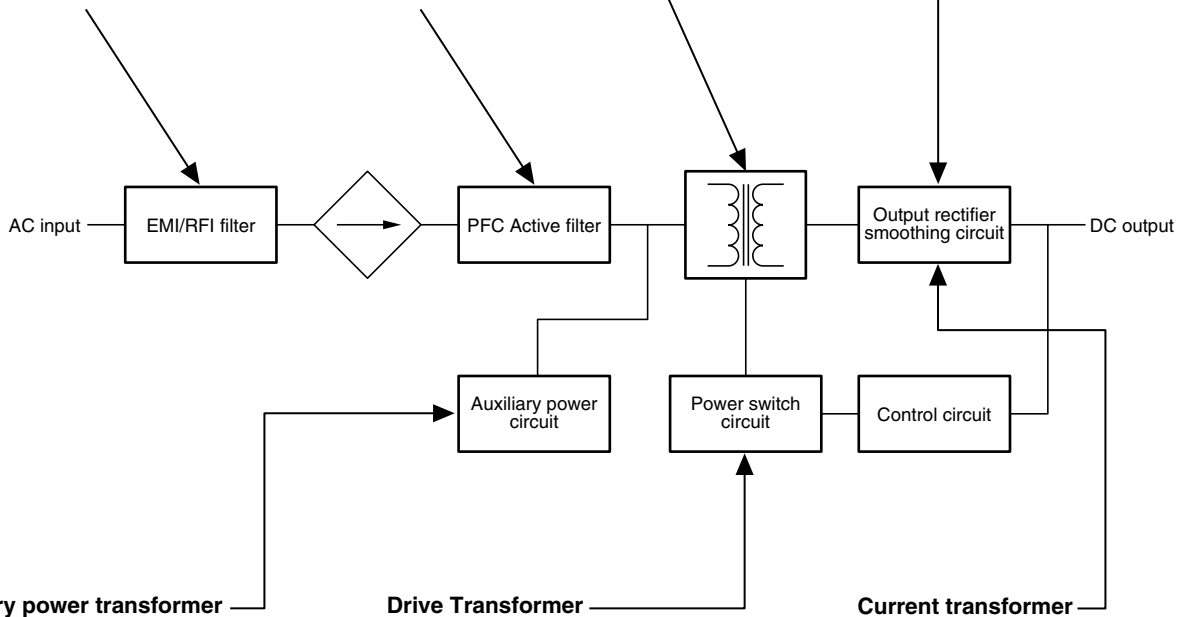

Auxiliary power transformer

Drive Transformer

Current transformer

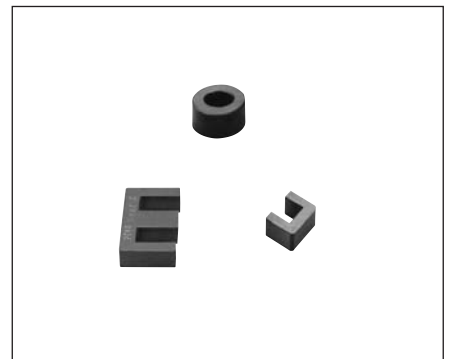
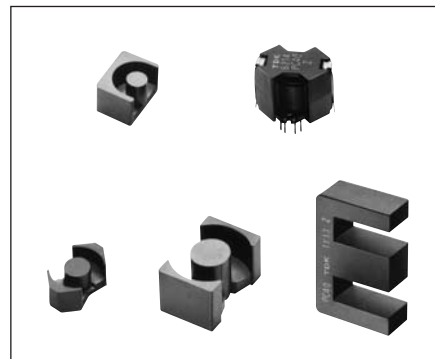
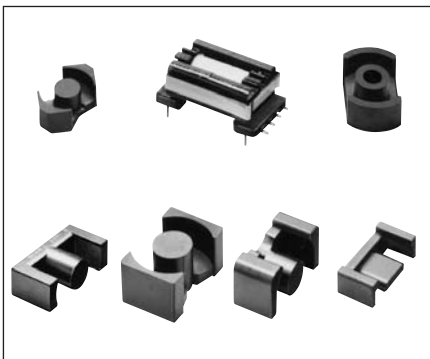

- Notes:
- LP and EPC cores are ideal for use in thin transformers.
 - LP cores are available in .5 and .7 inches in height (when mounted).
 - EP cores are available in .5 and .65 inches in height (when mounted).

SELECTED ITEMS OF LEGEND

$C_1 = \sum \frac{\ell}{A}$	Core constant mm^{-1}
Ae	Effective cross-sectional area, mm^2
ℓ_e	Effective magnetic path length, mm
Ve	Effective core volume mm^3
Acp	Cross-sectional center leg/pole area, mm^2
Acp min.	Minimum cross-sectional center pole area, mm^2
Acw	Cross-sectional winding area of core, mm^2
Aw	Cross-sectional winding area of bobbin, mm^2
ℓ_w	Average length of turns around bobbin, mm
t	Minimum thickness of bobbin inside which core is placed, including flanges, mm
W	Bobbin-core assembly dimensions
D	Bobbin-core assembly dimensions
H	Bobbin-core assembly dimensions

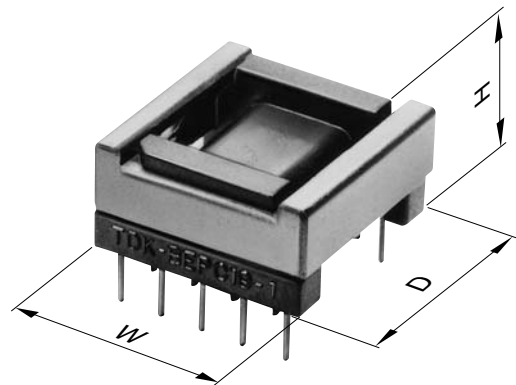
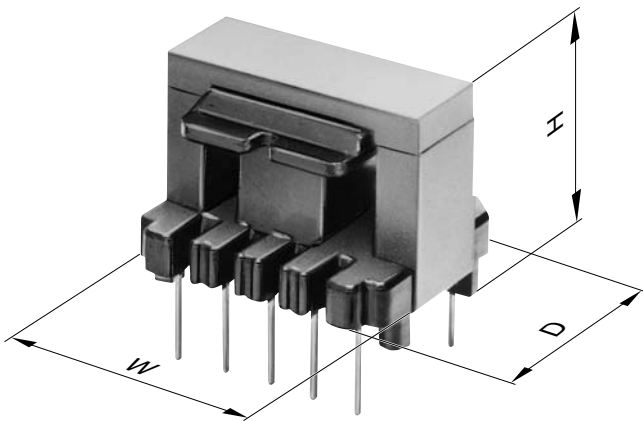

MATERIAL CHARACTERISTICS

MATERIAL CHARACTERISTICS

For Transformer and Choke

Material				PC40	PC44	PC47		
Initial permeability	μ_i			2300±25%	2400±25%	2500±25%		
Amplitude permeability	μ_a			3000 min.	3000 min.			
Core loss volume density (Core loss)* [B=200mT]	P _{cv}	kW/m ³	25kHz sine wave	25°C	120			
				60°C	80			
				100°C	70			
				120°C	85			
				25°C	600	600	600	
				60°C	450	400	400	
				100kHz sine wave	100°C	410	300	250
				120°C	500	380	360	
Saturation magnetic flux density* [H=1194A/m]	B _s	mT	25°C	510	510	530		
			60°C	450	450	480		
			100°C	390	390	420		
			120°C	350	350	390		
Remanent flux density*	B _r	mT	25°C	95	110	180		
			60°C	65	70	100		
			100°C	55	60	60		
			120°C	50	55	60		
Coercive force*	H _c	A/m	25°C	14.3	13	13		
			60°C	10.3	9	9		
			100°C	8.8	6.5	6		
			120°C	8	6	7		
Curie temperature	T _c	°C		>215	>215	>230		
Density*	d _b	kg/m ³		4.8×10 ³	4.8×10 ³	4.9×10 ³		
Electrical resistivity*	ρ_v	$\Omega \cdot m$		6.5	6.5	4.0		

Material				PC90	PC95	
Initial permeability	μ_i			2200±25%	3300±25%	
Amplitude permeability	μ_a					
Core loss volume density (Core loss)* [B=200mT]	P _{cv}	kW/m ³	100kHz sine wave	25°C	680	350
				60°C	470	
				100°C	320	290
				120°C	460	350
Saturation magnetic flux density* [H=1194A/m]	B _s	mT	25°C	540	530	
			60°C	500	480	
			100°C	450	410	
			120°C	420	380	
Remanent flux density*	B _r	mT	25°C	170	85	
			60°C	95	70	
			100°C	60	60	
			120°C	65	55	
Coercive force*	H _c	A/m	25°C	13	9.5	
			60°C	9	7.5	
			100°C	6.5	6.5	
			120°C	7	6.0	
Curie temperature	T _c	°C		>250	>215	
Density*	d _b	kg/m ³		4.9×10 ³	4.9×10 ³	
Electrical resistivity*	ρ_v	$\Omega \cdot m$		4.0	6.0	

* Average value

** 500kHz, 50mT

For Common Mode Choke

Material				HS52	HS72	HS10	HS12
Initial permeability	μ			5500±25%	7500±25% (2000min. at 500kHz)	10000±25%	12000±25% (at 150kHz)
Relative loss factor*	$\tan\delta/\mu$	$\times 10^{-6}$		10(100kHz)	30(100kHz)	30(100kHz)	20(100kHz)
Saturation magnetic flux density* [H=1194A/m]	Bs	mT	25°C	410	410	380	430
Remanent flux density*	Br	mT	25°C	70	80	120	80
Coercive force*	Hc	A/m	25°C	6	6	5	6
Curie temperature	Tc	°C		>130	>130	>120	>130
Density*	db	kg/m ³		4.9×10 ³	4.9×10 ³	4.9×10 ³	4.9×10 ³
Electrical resistivity*	ρ_V	$\Omega \cdot m$		1	0.2	0.2	0.5

For Telecommunication

Material				H5A	H5B2	H5C2	H5C3
Initial permeability	μ			3300 ^{+40%} _{-0%}	7500±25%	10000±30%	15000±30%
Relative loss factor	$\tan\delta/\mu$	$\times 10^{-6}$		<2.5(10kHz) <10(100kHz)	<6.5(10kHz)	<7.0(10kHz)	<7.0(10kHz)
Temperature factor of initial permeability	$\alpha\mu$	$\times 10^{-6}$	-30 to +20°C	-0.5 to 2.0	0 to 1.8	-0.5 to 1.5	-0.5 to 1.5
			0 to 20°C 20 to 70°C	-0.5 to 2.0	0 to 1.8	-0.5 to 1.5	-0.5 to 1.5
Saturation magnetic flux density* [H=1194A/m]	Bs	mT	25°C	410	420	400	360
Remanent flux density*	Br	mT	25°C	100	40	90	105
Coercive force*	Hc	A/m	25°C	8.0	5.6	7.2	4.4
Curie temperature	Tc	°C		>130	>130	>120	>105
Hysteresis material constant	η_B	$\frac{10^{-6}}{mT}$		<0.8	<1.0	<1.4	<0.5
Disaccommodation factor	D _F	$\times 10^{-6}$		<3	<3	<2	<2
Density*	db	kg/m ³		4.8×10 ³	4.9×10 ³	4.9×10 ³	4.95×10 ³
Electrical resistivity*	ρ_V	$\Omega \cdot m$		1	0.1	0.15	0.15

Material				H5C4	HP5	DNW45	DN70
Initial permeability	μ			12000±30% 9000(-20°C)	5000±20%	4200±25%	7500±25%
Relative loss factor	$\tan\delta/\mu$	$\times 10^{-6}$	25°C, 10kHz	<8(10kHz)	<3.5	<3.5	<2.0
Temperature factor of initial permeability	$\alpha\mu$	$\times 10^{-6}$	-30 to +20°C				-0.5 to 1.5
			0 to 20°C 20 to 70°C		±12.5% ±12.5%		-0.5 to 1.5
Saturation magnetic flux density* [H=1194A/m]	Bs	mT	25°C	380	400	450	390
Remanent flux density*	Br	mT	25°C	100	65	50	45
Coercive force*	Hc	A/m	25°C	4.4	7.2	6.5	3.5
Curie temperature	Tc	°C		>110	>140	>150	>105
Hysteresis material constant	η_B	$\frac{10^{-6}}{mT}$		<2.8	<0.4	<0.8	<0.2
Disaccommodation factor	D _F	$\times 10^{-6}$		<3	<3	<3	<2.5
Density*	db	kg/m ³		4.95×10 ³	4.8×10 ³	4.85×10 ³	5.0×10 ³
Electrical resistivity*	ρ_V	$\Omega \cdot m$		0.15	0.15	0.65	0.3

* Average value

μ_i vs. Frequency Characteristics

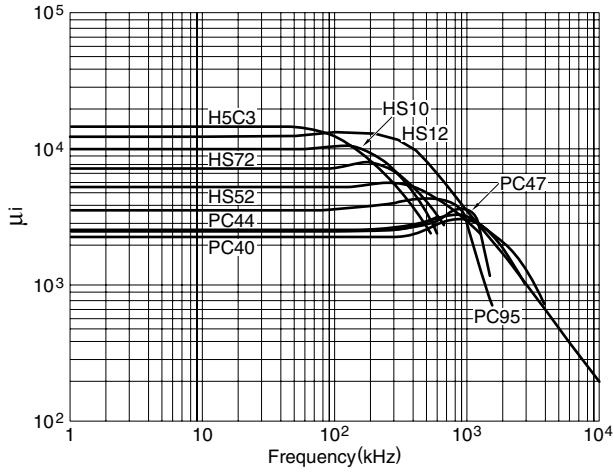

$\tan\delta/\mu_i$ vs. Frequency Characteristics

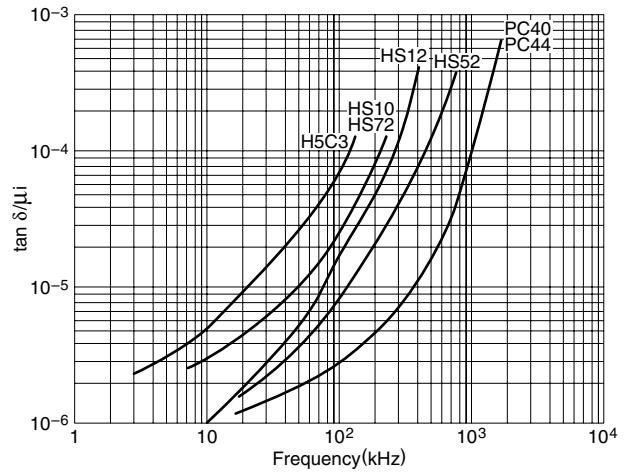

Magnetization Curves (Typical)

Material: PC40

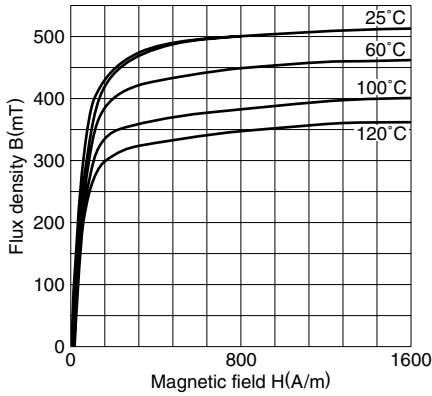

Material: PC44

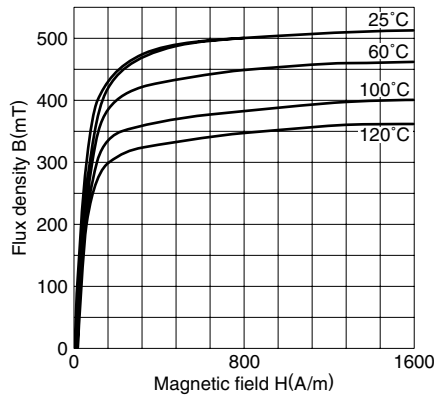

Material: PC47

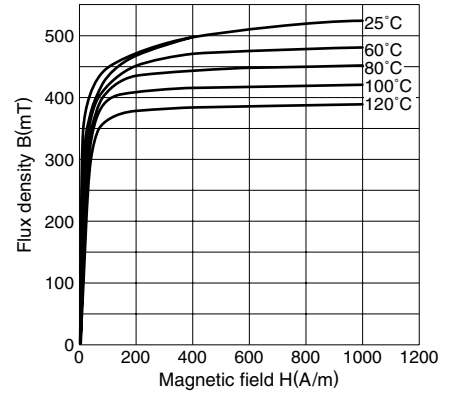

Material: PC90

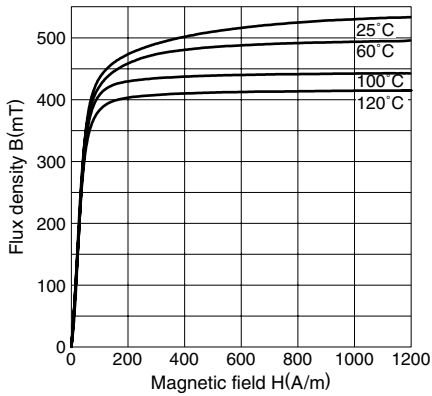

Material: PC95

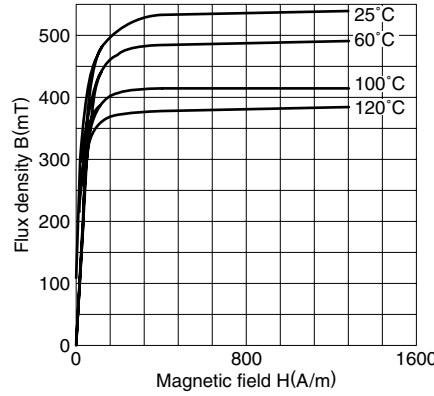

• All specifications are subject to change without notice.

Core Loss (Typical)

Material: PC40

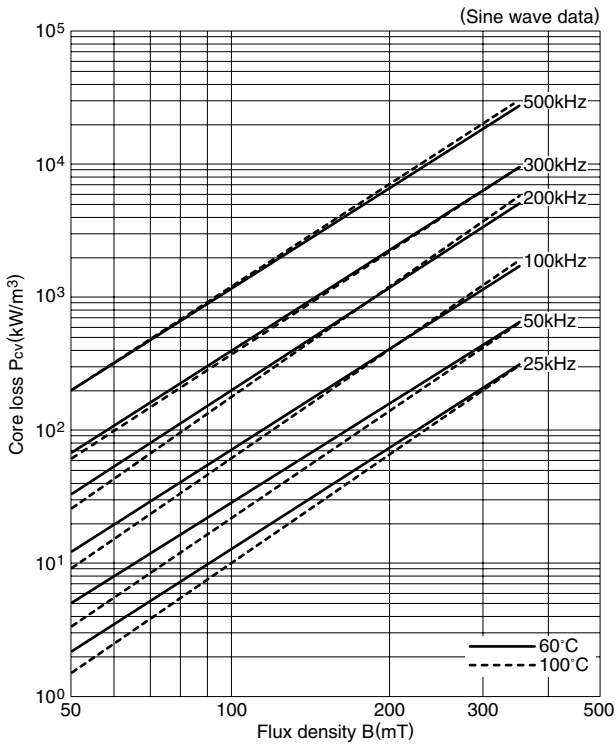

Material: PC44

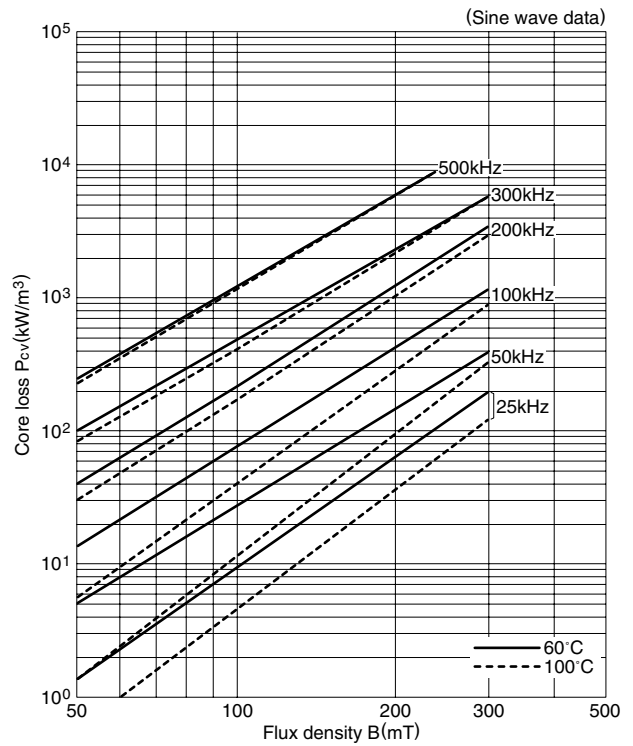

Material: PC47

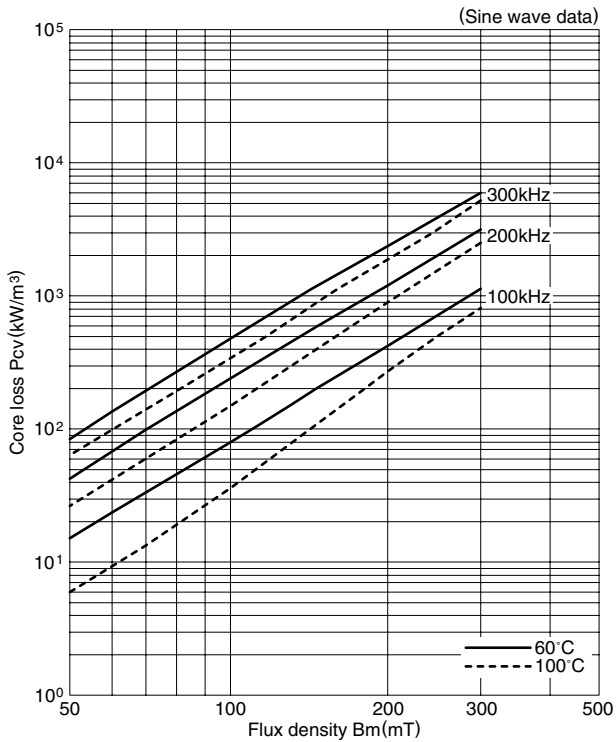

Material: PC90

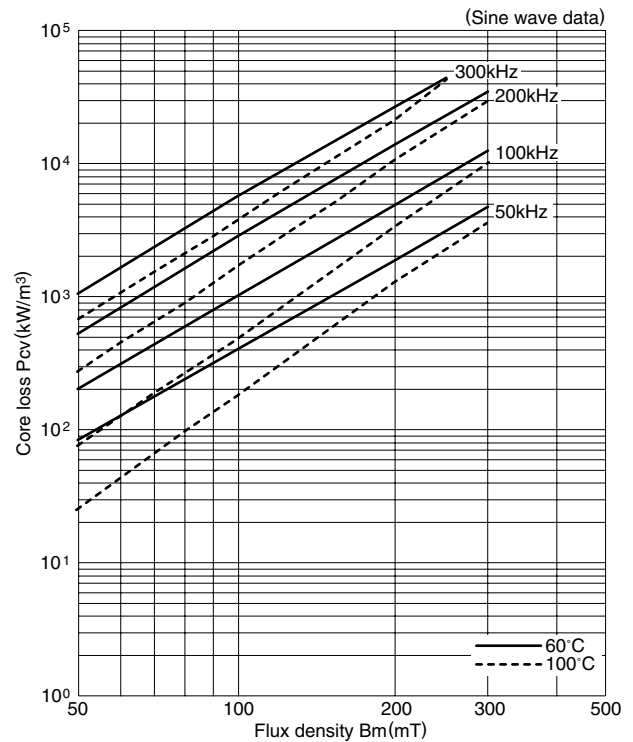

• All specifications are subject to change without notice.

Core Loss (Typical)

Material: PC95

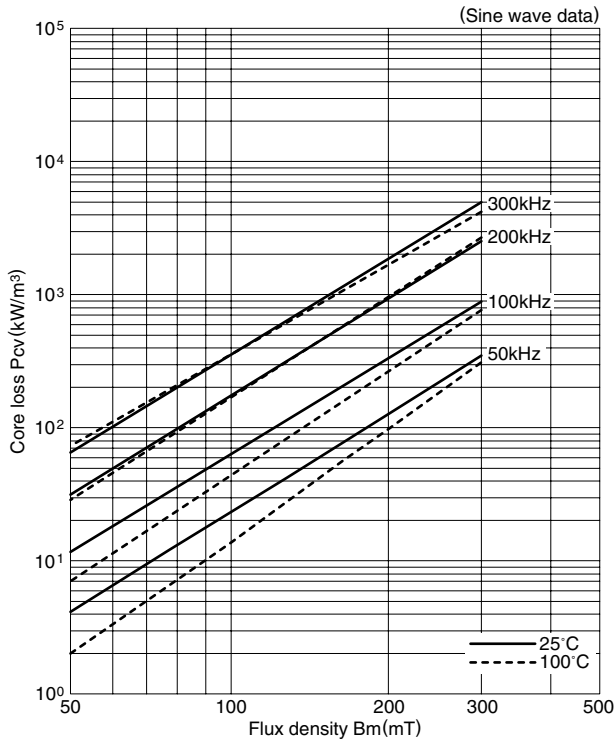

Temperature Dependence of Core Loss (Typical)

Material: PC40 (Frequency: 100kHz)

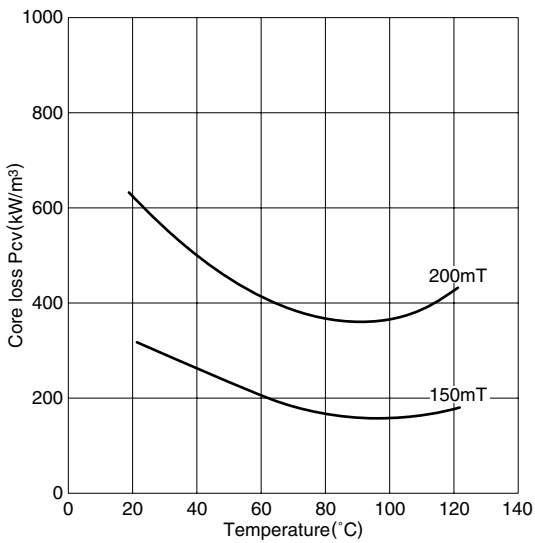

Material: PC44 (Frequency: 100kHz)

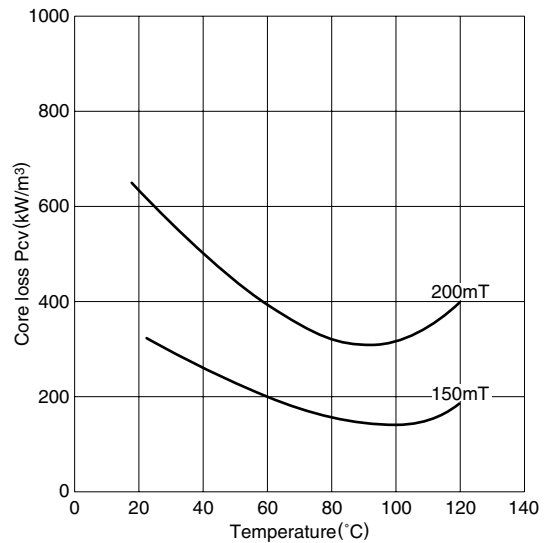

Test core: Toroidal
OD=31mm
TH=8mm
ID=19mm

Temperature Dependence of Core Loss (Typical)

Material: PC47

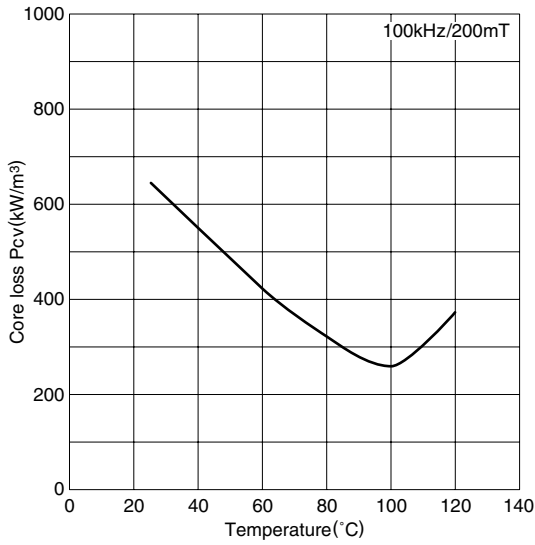

Material: PC90

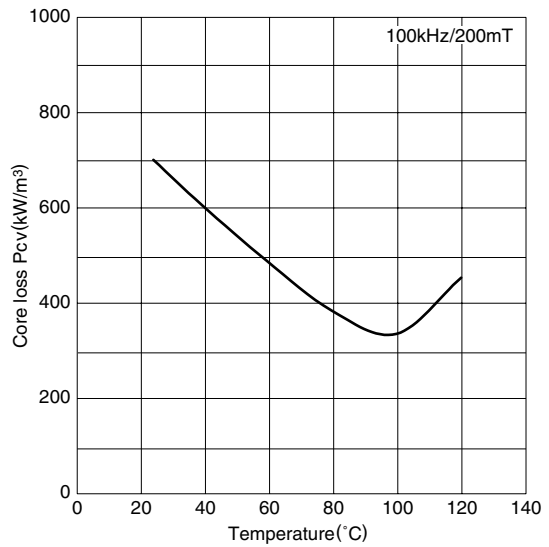

Material: PC95

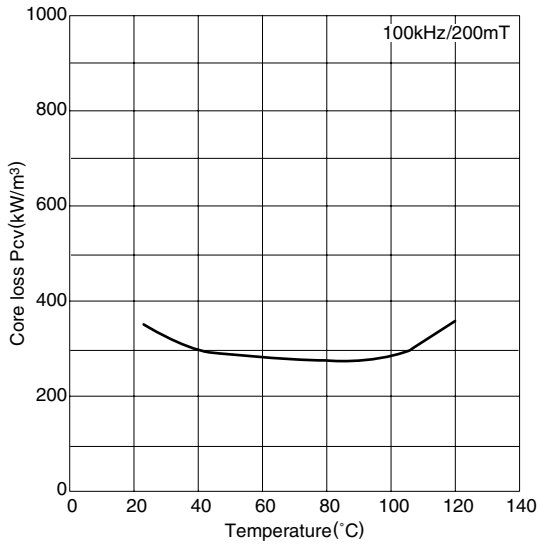

Magnetization Curves (Typical)

HS52

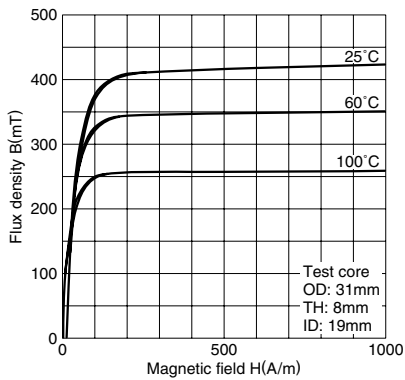

HS72

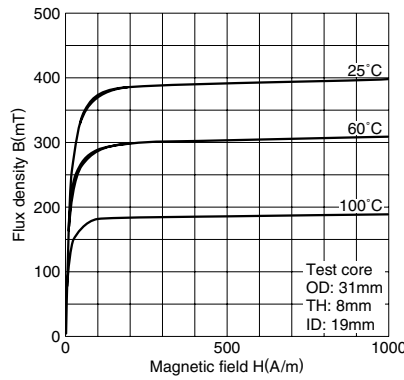

HS10

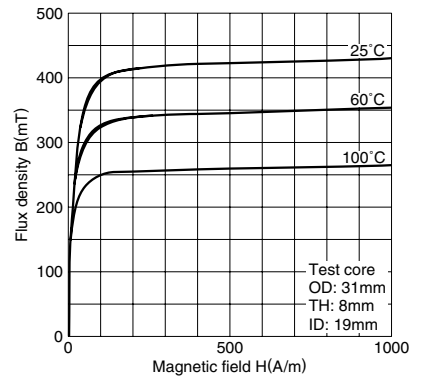

• All specifications are subject to change without notice.

μ_i vs. Temperature Characteristics (Typical)

PC40

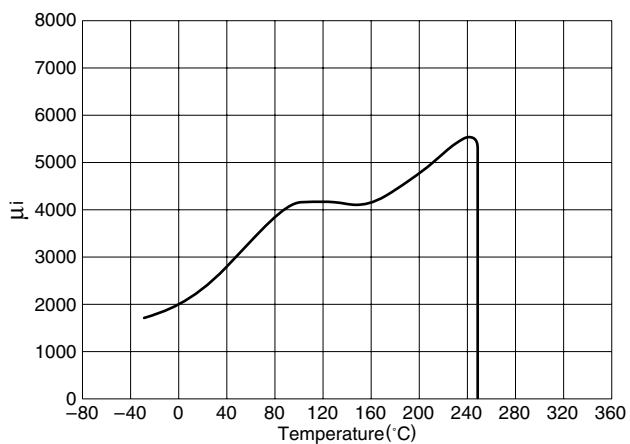

PC44

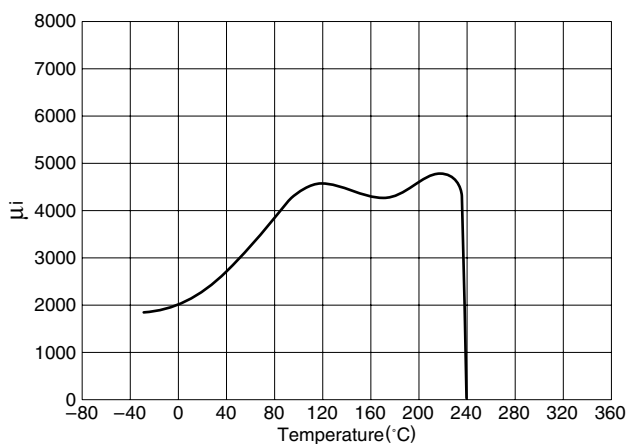

PC47

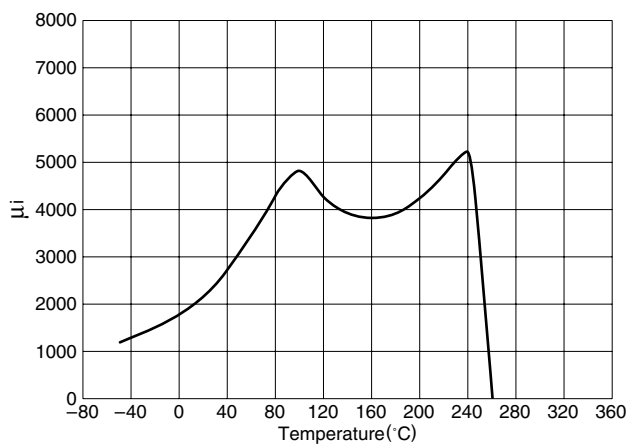

PC90

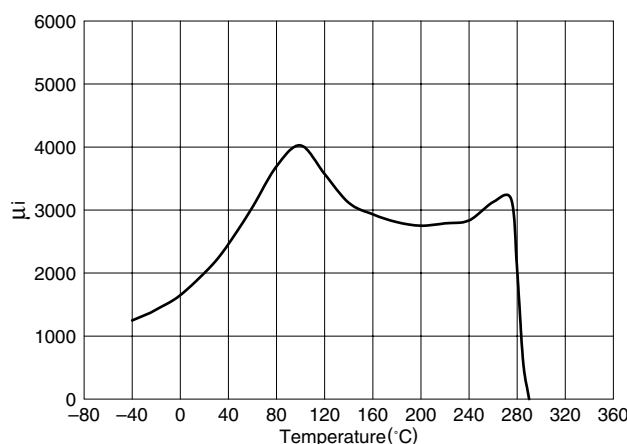

PC95

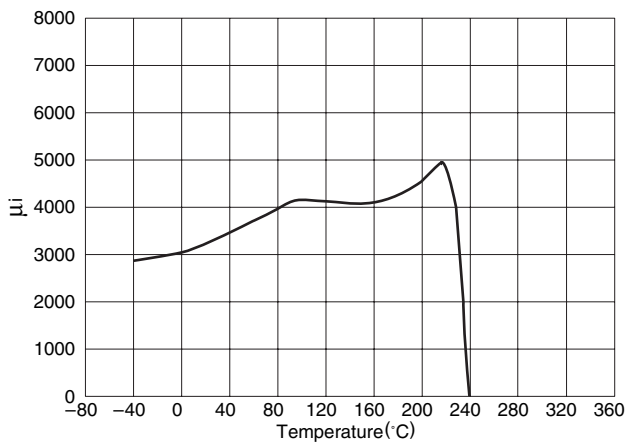

μ_i vs. Temperature Characteristics (Typical)

HS52

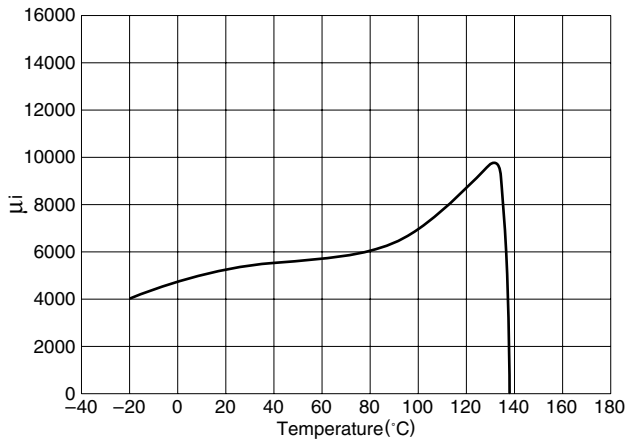

HS72

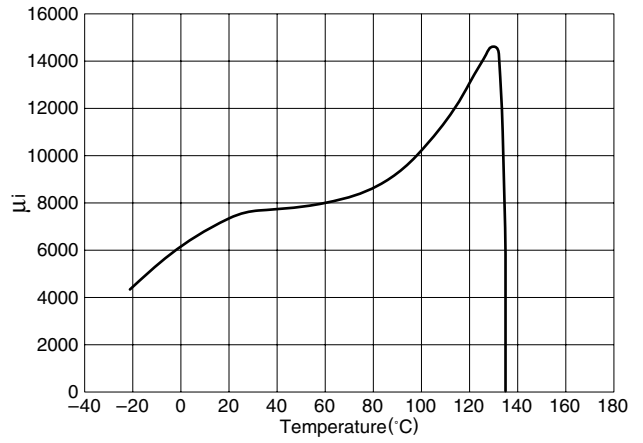

HS10

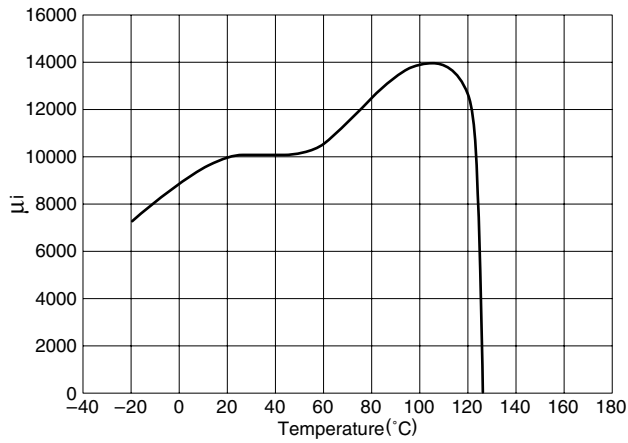

Test core: OD=31mm
TH=8mm
ID=19mm

HS12

