

HITACHI

SERVICE MANUAL

TY

No.508 EGF

HA-D100/FT-D100
(US,CS,BS,SA,ES,VS,KS,ZS,EW)

RTV servis Horvat

Kešinci, 31402 Semeljci

031-856-139

031-856-637

098-788-319

rtv-servis-horvat@ostel.hr

Croatia

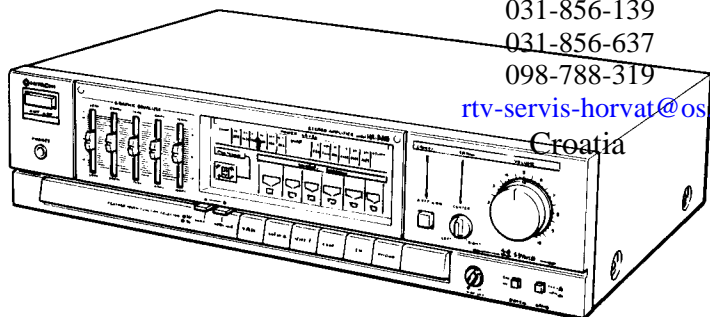

HA-D100

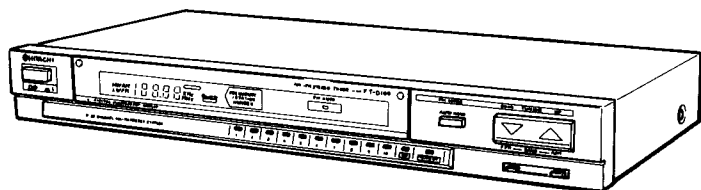

FT-D100

CONTENTS · INHALT · SOMMAIRE

SPECIFICATIONS · TECHNISCHE DATEN · CARACTÉRISTIQUES TECHNIQUES	2,3
CIRCUIT BOARD CHECKING AND ESCUTCHEON DISASSEMBLY PROCEDURES · PRÜFUNG DER LEITERPLATTE UND FRONT-PLATTEN-DEMONTAGEVORGÄNGE · CONTROLE DE CARTE A CIRCUITS IMPRIMÉS ET PROCÉDÉ DE DEMONTAGE DE PLAQUE DÉCORATIVE	4
SERVICE POINT · WARTUNGSPUNKTE · POINTS DE SERVICE	5
CHECKING THE OPERATION OF THE PROTECTION CIRCUIT · KONTROLL DER FUNKTION DER SCHUTZSCHALTUNG · CONTRÔL DE FONCTIONNEMENT DU CIRCUIT DE PROTECTION	6-8
DESCRIPTION OF NEW CIRCUIT · BESCHREIBUNG DES NEUEN · DESCRIPTION DES NOUVEAUX CIRCUITS	9,10
WIRING DIAGRAM · SCHALTPLAN · SCHÉMA DE CABLAGE	11,12
PRINTED WIRING BOARD · PRINTPLATTEN · PLAN DE BASE	13,14,17,18
CIRCUIT DIAGRAM · SCHALTPLAN · PLAN DE CIRCUIT	15,16,19,20
BLOCK DIAGRAM · BLOCK CHEMA · SCHÉMA	21
REPLACEMENT PARTS LIST · ERSATSTEILLISTE · TABLEAU DES PIÈCE	22-27

The FT-D100 mentioned in this manual is no different from the FT-57, the model previously put on sale, except that its esthetic design as well as the color of its LEDs is new.

This manual covers only those items differing from the FT-57 (Circuit diagram, Printed wiring board and Replacement parts list) and, as such, should be used with the FT-57 service manual (No. 441EGF) as its companion.

Das in dieser Anleitung erwähnte Modell FT-D100 unterscheidet sich vom Vorgängermodell FT-57 im wesentlichen nur in der äußeren Gestaltung und der Farbe der LEDs. Diese Anleitung geht nur Diese Anleitung behandelt nur Punkte, die sich von Modell FT-57 unterscheiden (Schaltplan, Leiterplatte und Ersatzteilliste), so daß sie gemeinsam mit der FT-57 Wartungsanleitung (Nr. 441EGF) verwendet werden soll.

Le modèle FT-D100 mentionné dans le présent manual ne présente aucune différence notable avec le modèle FT-57, modèle antérieurement mis en vente, exception faite de la refonte de son aspect extérieur et de la teinte des diodes électroluminescentes (LED). Ce manuel ne traite que des points Ce manuel ne traite que des points différents du modèle FT-57 (schéma de principe, schéma de câblage et liste des composants et pièces de rechange) de sorte qu'il doit utilisé avec le manuel de dépannage du modèle FT-57 (No. 441 EGF).

SAFETY PRECAUTION

The following precautions should be observed when servicing.

1. Since many parts in the unit have special safely related characteristics, always use genuine Hitachi's replacement parts. Especially critical parts in the power circuit block should not be replaced with other makers. Critical parts are marked with Δ in the circuit diagram and printed wiring board.
2. Before returning a repaired unit to the customer, the service technician must thoroughly test the unit to ascertain that it is completely safe to operate without danger of electrical shock.

SPECIFICATIONS AND PARTS ARE SUBJECT TO CHANGE FOR IMPROVEMENT.

STEREO AMPLIFIER/AM-FM STEREO TUNER

July 1986 TOYOKAWA WORKS

SICHERHEITSMASSNAHMEN

Bei Wartungsarbeiten sind die folgenden Sicherheitsmaßnahmen zu beachten:

- Da verschiedene Teile dieses Gerätes Sicherheitsfunktionen aufweisen, nur Original-Hitachi-Ersatzteile verwenden. Kritische Teile im Netzteil sollten nicht durch ähnliche Teile anderer Hersteller ersetzt werden. Alle kritischen Teile sind im Schaltplan und im Diagramm der Schaltplatinen mit dem Symbol Δ gekennzeichnet.
- Vor der Auslieferung eines reparierten Gerätes an den Kunden muß der Wartungstechniker das Gerät einer gründlichen Prüfung unterziehen, um sicherzustellen, daß sicherer Betrieb ohne die Gefahr von elektrischen Schlägen gewährleistet ist.

PRÉCAUTIONS DE SÉCURITÉ

Les précautions suivantes doivent être observées chaque fois qu'une réparation doit être faite.

- Étant donné que de nombreux composants de l'appareil possèdent des caractéristiques relatives à la sécurité, utiliser uniquement des pièces de rechange d'origine Hitachi pour effectuer un remplacement. Ceci se rapporte notamment aux pièces critiques du bloc d'alimentation qui ne doivent en aucun cas être remplacées par celles d'autres fabricants. Les pièces critiques sont accompagnés du symbole Δ dans le schéma de montage et sur le schéma de plaque de câblage.
- Avant de retourner l'appareil réparé au client le technicien doit procéder à un essai complet pour s'assurer qu'il ne présente aucun danger de chocs électriques.

SPECIFICATIONS

Power output (Both channels driven) 100 Watts* per channel, min. RMS, at 8 ohms from 20 Hz to 20 kHz, with no more than 0.3% total harmonic distortion, 105W/ch + 105W/ch (8 ohms, 1 kHz, T.H.D. 0.2% I.E.C.)

Harmonic distortion (8 ohms) (at 1/2 rated output) 0.2%

Intermodulation distortion (at 1/2 rated output) 0.2%

Frequency characteristics PHONO 20 Hz – 20 kHz, RIAA \pm 0.5 dB

CD, TUNER, VIDEO-1,2 TAPE 20 Hz – 30 kHz (\pm 3 dB)

Input sensitivity/Impedance PHONO 3 mV/50 kohms
CD, TUNER, VIDEO-1,2, TAPE PLAY 180 mV/50 kohms

Output level TAPE REC OUT 180 mV/1 kohms

Phono overload level (at 1 kHz T.H.D. 0.1%) 120 mV

Signal-to-noise-ratio (IHF, A network)

PHONO 70 dB
CD, TUNER, VIDEO-1,2 TAPE 85 dB

Damping factor 30 (1 kHz, 8 ohms)

Graphic Equalizer \pm 11 dB (63 Hz, 250 Hz, 1 kHz, 4 kHz, 16 kHz)

Loudness control +6 dB (100 Hz)
+3 dB (10 kHz)

Power supply AC 120 V, 60 Hz (US, CS)
~240 V, 50 Hz (BS, SA)
~220 V, 50 Hz (ES, VS, KS, ZS)
~240 V, 220 V, 120 V, 50/60 Hz (EW)

Power consumption 500 W (at rated output) (~240V)
400 W (at 1/3 rated output) (AC 120 V)

Dimensions 435(W) X 110(H) X 292(D) mm

Weight 7.7 kg

*Measured pursuant to the Federal Trade Commission's Trade Regulation Rule on Power Output Claims for Amplifiers.

TECHNISCHE DATEN.

Ausgangsleistung (2-Kanalbetrieb) 100 Watt /Kanal min. RMS bei 8 Ohms von 20 Hz bis 20 kHz, mit 0.3% Klirr
105 Watt/Kanal + 105 Watt/Kanal (8 Ohms, 1 kHz, T.H.D. 0.2% I.E.C.)

Klirrfaktor (8 Ohms) (be halber Nennleistung) 0.2%

Intermodulationsverzerrung (bei halber Nennleistung) 0.2%

Frequenzcharakteristik PHONO 20 Hz – 20 kHz, RIAA-Kennlinie \pm 0.5 dB

CD, TUNER, VIDEO-1,2 TAPE 20 Hz – 30 kHz (\pm 3 dB)

Eingangsempfindlichkeit/Impedanz PHONO 3 mV/50 kOhms
CD, TUNER, VIDEO-1,2 TAPE PLAY 180 mV/50 kOhms

Ausgangspegel TAPE REC OUT 180 mV/1 kOhm

Phonoüberlastungspegel (bei 1 kHz, 0.1% Klirrer) 120 mV

Geräuschspannungsabstand (IHF, A-Nets)

PHONO 70 dB
CD, TUNER, AUX-1,2 TAPE 85 dB

Dämpfungsfaktor 30 (1 kHz, 8 Ohms)

Graphic Equalizer \pm 11 dB (63 Hz, 250 Hz, 1 kHz, 4 kHz, 16 kHz)

Gehörliche Lautstärkekorrektur +6 dB (100 Hz)
+3 dB (10 kHz)

Netzspannung Net 120 V, 60 Hz (US, CS)
~240 V, 50 Hz (BS, SA)
~220 V, 50 Hz (ES, VS, KS, ZS)
~240 V, 220 V, 120 V, 50/60 Hz (EW)

Leistungsaufnahme 500 W (bei Nennleistung) (Nets 240 V)
400 W (bei 1/3 Nennleistung) (Net 120 V)

Abmessungen 435(W) X 110(H) X 292(T) mm
Gewicht 7.7 kg

Änderungen der Konstruktion und technischen Daten bleiben im Sinne der ständigen Verbesserung vorbehalten.

CARACTERISTIQUES TECHNIQUES.

Puissance de sortie (deux canaux)	100 Watt per canal, min: RMS à 8 ohms de 20 Hz à 20 kHz avec une distorsion harmonique totale inférieure à 0,3% 105 W/canal + 105 W/canal (8 ohms, 1 kHz, D.H.T. 0.2% I.E.C.)
Distorsion harmonique (8 ohms) (à 1/2 de sortie nominale)	0.2%
Distorsion d'intermodulation (à 1/2 de sortie nominale)	0.2%
Caractéristiques de fréquence	
PHONO	20 Hz à 20 kHz, RIAA ±0.5 dB
CD, TUNER, VIDEO-1,2	
TAPE	20 Hz à 30 kHz (±3 dB)
Sensibilité d'entrée/Impédance	
PHONO	3 mV/50 kohms
CD, TUNER, VIDEO-1,2	180 mV/50 kohms
TAPE PLAY	180 mV/50 kohms
Niveau de sortie	
TPAE REC OUT	180 mV/1 kohms
Niveau de surcharge de table de lecture	
(à 1 kHz, D.H.T. 0.1%)	120 mV

Rapport signal/bruit (IHF, réseau A)

PHONO	70 dB
CD, TUNER, AUX VIDEO-1,2	85 dB
TAPE	85 dB
Facteur d'amortissement	30 (1 kHz, 8 ohms)
Equaliseur graphique	±11 dB (63 Hz, 250 Hz, 1 kHz, 4 kHz, 16 kHz)
Réglage des aigues	+ 6 dB (100 Hz) + 3 dB (10 kHz)
Correction physiologique	
Alimentation	
	CA120 V, 60 Hz (US, CS) ~240 V, 50 Hz (BS, SA) ~220 V, 50 Hz (ES, VS, KS, ZS) ~240 V, 220 V, 120 V, 50/60 Hz (EW)
Consommation	
	500 W (à la puissance nominale) (CA240 V) 400 W (à 1/3 de la puissance) (CA120 V)
Dimensions	
Poids	435(L) X 110(H) X 292(P) mm 7.7 kg

Les caractéristiques techniques et la présentation peuvent être modifiées sans préavis pur des raisons d'amélioration.

Check that exposed parts are acceptably insulated from the supply circuit before returning the instrument repaired to the customer.

● Checking method

Power switch is set to ON.

Next, measure the resistance value between the both poles of attachment cup (Power supply plug) and the exposed parts (Parts such as Ground terminal, Knob, Cover, etc. where the customer is easy to touch) and check that the resistance value is 500 kohms or more.

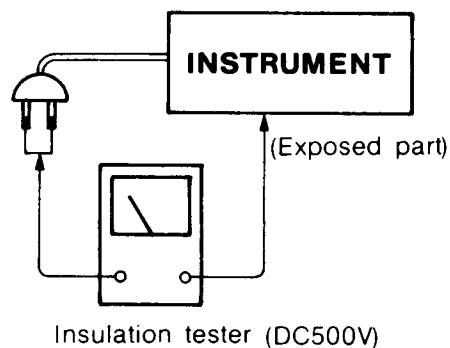

CIRCUIT BOARD CHECKING AND ESCUTCHEON ASS'Y DISASSEMBLY PROCEDURES.
PRÜFUNG DER LEITERPLATTE UND FRONTPLATTEN-DEMONTAGE-VORGÄNGE.
CONTROLE DE CARTE A CIRCUITS IMPRIMÉS ET PROCEDE DE DEMON-TAGE DE PLAQUE DÉCORATIVE.

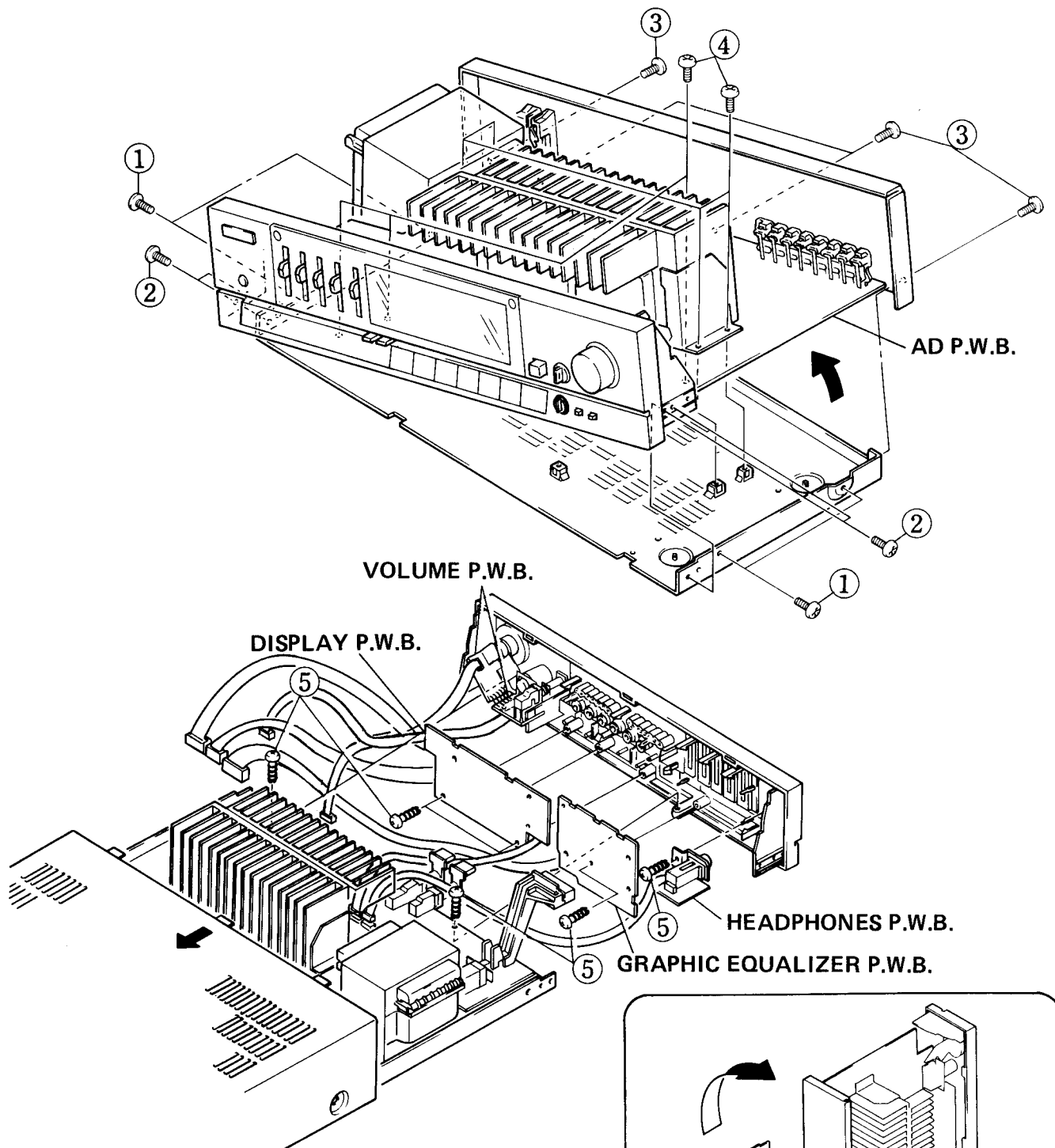

- ① Screw, bind head 4φx10 (x4)
- ② Screw, bind head 3φx8 (x4)
- ③ Screw, bind head 3φx8 (x4)
- ④ Screw, bind head 3φx12 (x7)
- ⑤ Screw, tapping bind head 3φx10 (x6)

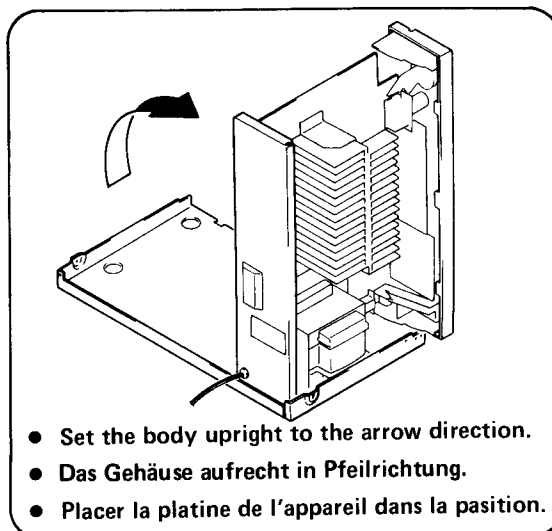

SERVICE POINT • WARTUNGSPUNKTE • POINTS DE SERVICE.

- **As this unit uses a large capacity power supply, be careful of the following points when checking and repairing.**

- (1) To check and repair the printed wiring boards, be sure to cut off the power and pull out the power cord. Remove the bottom plate and discharge the power capacitors by touching it with a resistor of approx. 10 ohms, 5 watts capacity at the positions C801 and C802.
- (2) This amplifier employs a heat sink and so when conducting a continuity check, the unit should be placed horizontally or stood on its transformer end.

- **Parts installation method**

Great care is taken in installing parts to improve the safety of products. For example, parts are covered with tubes, or they are kept away from the printed wiring board surface. Be sure to maintain the previous conditions after replacing parts for repair.

- **Da dieses Gerät mit einer Stromversorgung hoher Kapazität ausgerüstet ist, müssen bei Prüfungen bzw. Reparaturen die folgenden Punkte beachtet werden.**

- (1) Für das Prüfen bzw. Reparieren der Schaltplatte unbedingt die Stromversorgung abschalten und das Netzkabel von der Wandsteckdose abziehen. Die Bodenplatte abmontieren und die Leistungskondensatoren entladen, indem die Klemmen an den Punkten C801 und C802 mit einem Widerstand von etwa 10 Ohm (5 W) berührt werden.
- (2) Dieser Verstärker verwendet eine Wärmeschleife, so daß das Gerät bei einer Durchgangsprüfung horizontal oder auf das Transformatorende gestellt werden sollte.

- **Finbau der Teile**

Bei der Montage des Gerätes wurde besonderes Augenmerk auf Betriebssicherheit gelegt, so daß alle Teile besonders sorgfältig eingebaut wurden. Zum Beispiel wurden bestimmte Leiter mit Kunststoffschläuchen überzogen oder andere in sicherem Abstand von der Schaltplatte angeordnet. Beim Austauschen bzw. Reparieren von Teilen ist daher darauf zu achten, daß die ursprünglichen Sicherheitsmaßnahmen wiederum eingehalten werden.

- **Etant donné que cet appareil emploie une importante capacité d'énergie, faire attention aux points suivants au moment d'effectuer des contrôles et des réparations.**

- (1) Pour contrôler et vérifier les plaques à circuit imprimé, ne pas oublier de couper l'alimentation et de débrancher le cordon secteur. Déposer la plaque de fond et décharger les condensateurs de puissance en les touchant avec une résistance d'environ 10 ohms, 5 watts de capacité aux points C801 et C802.
- (2) Cet amplificateur est doté d'un dissipateur thermique et c'est pourquoi il doit être placé à l'horizontale ou sur son extrémité transformateur quand on procède à un essai de continuité.

- **Procédé de montage des pièces**

Les pièces sont montées en usine avec le plus grand soin pour assurer une sécurité intégrale à l'appareil. Par exemple, les pièces sont protégées par des tubes au tenues à distance des plaquettes à circuit imprimé. S'assurer que ces précautions sont également respectées au remontage.

CHECKING THE OPERATION OF THE PROTECTION CIRCUIT

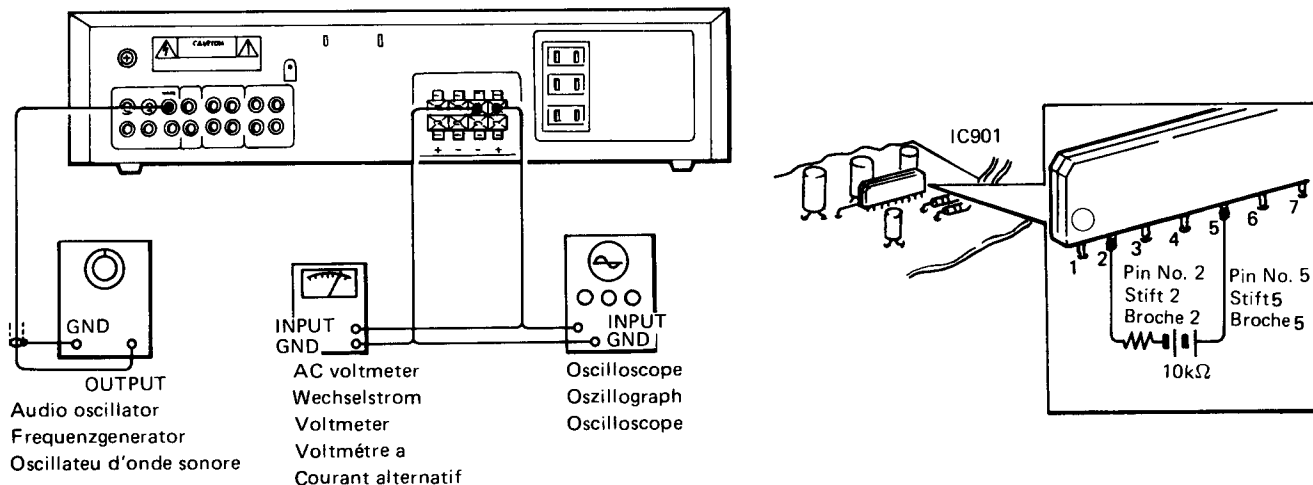

When the output circuit is repaired by replacing the output transistors, etc., perform an operation check on the ASO (Area of Safe Operation) detection circuit for the output transistors and the speaker protection circuit.

1. Operation check of the ASO detection circuit for the output transistors

Connect the audio oscillator to the TUNER IN terminals and the speaker terminals unloaded (speaker: disconnect). Set the frequency of the audio oscillator at 1 kHz and adjust the level of the input signal so that the voltage at the speaker terminals is approx. 5 V rms.

Under these conditions, short-circuit the speaker terminals of the channel to which the input signal is applied using a lead wire, etc. If this short-circuit makes the ASO detection circuit operate, no output appears at the speaker terminals even if the lead wire used for short-circuiting is removed.

Next, turn off the power switch and, after approx. 10 sec., turn the power switch on again. When output comes out of the speaker terminals, this indicates that the ASO detection circuit is operating normally.

2. Operation check of the speaker protection circuit

Make sure that the relay operates (a click sound is heard) approx. 7 – 10 seconds after the power switch is turned on with the speaker terminals unloaded (speaker: disconnect).

Next, when a resistor with a resistance of approximately 10 k ohms and two 1.5 V dry batteries are connected in series across pins 5 and 2 of main power printed wiring board IC901, the relay turns off within 1 sec. Next, when power is turned on again after at least 10 seconds have passed, the relay takes 7 – 10 seconds to start activating. Next, change the polarities of the dry batteries and carry out the above mentioned operation to check the operation of the relay.

If the relay is energized with this operation, it means that the speaker protection circuits are functioning normally.

When conducting this operational check, take care not to create shortcircuits with parts close at hand.

• Phenomena and remedy when the protection circuit operates

Type of protection circuit	Phenomenon when the protection circuit operates	Cause	Remedy
1 Muting circuit	No sound comes out about 7 – 10 sec. after the power switch is turned ON.	_____	Normal
2 Protection circuit of the output transistors	1. No sound comes out. 2. When the power switch is turned ON, the relay becomes ON, then OFF when the signal is applied.	Short circuit of speaker output terminal.	Turn off the power switch, check whether the speaker terminal is short circuited or not, and turn ON again.
3 Speaker protection circuit (DC voltage detection/protection circuit)	1. No sound comes out. 2. Neutral point voltage is more than ± 2 V. 3. After the power switch is turned ON, relay doesn't turn ON.	Power amplifier faulty, etc.	Repair faulty parts in power amplifier.

KONTROLLE DER FUNKTION DER SCHUTZSCHALTUNG

Falls die Ausgangsschaltung repariert wurde, indem z.B. die Ausgangstransistoren usw. erneuert wurden, dann müssen die Ausgangstransistoren der ASO-Schutzschaltung (ASO = Area of Safe Operation) und die Tätigkeit der Lautsprecher-Schutzschaltung wie nachfolgend beschrieben kontrolliert werden.

1. Funktionsprüfung der ASO-Schaltung für die Ausgangstransistoren

Den Frequenzoszillator an die TUNER IN anschließen, wobei die Lautsprecherklemmen keine Last aufweisen dürfen (Lautsprecher nicht angeschlossen). Die Frequenz des Frequenzoszillators auf 1 kHz einstellen und den Pegel des Eingangssignales so abgleichen, daß die Spannung an den Lautsprecherklemmen etwa 5 V (Mittelwert, bewertet) beträgt. In diesem Zustand sind die Lautsprecherklemmen kurzzuschließen, und zwar die Klemmen jenes Kanals, an welchen das Eingangssignal angelegt wurde. Falls dieser Kurzschluß zu einem Ansprechen der ASO-Schutzschaltung führt, dann erscheint kein Ausgangssignal an den Lautsprecherklemmen, auch nicht wenn den zum Kurzschließen der Klemmen verwendete Draht entfernt wird.

Danach den Netzschalter abschalten und nach etwa 10 Sekunden wieder einschalten. Wenn nun ein Ausgangssignal an den Lautsprecherklemmen festgestellt wird bedeutet dies, daß die ASO-Schutzschaltung richtig arbeitet.

2. Funktionsprüfung der Lautsprecher-Schutzschaltung

Darauf achten, daß etwa 7 – 10 Sekunden nach dem Einschalten des Netzschalters ein Schaltgeräusch des Relais vernommen werden kann, wenn keine Last an den Lautsprecherklemmen anliegt (Lautsprecher nicht angeschlossen).

Wenn ein Widerstand mit einem Widerstand von ca. 10 kOhm und zwei 1,5 V Trockenbatterien in Serie mit Stift 5 und Stift 2 von IC901 der gedruckten Schaltung parallelgeschaltet werden, wonach das Relais innerhalb einer Sekunde abschalten sollte. Wird danach nach mindesten 10 Sekunden die Stromversorgung wieder eingeschaltet, dann benötigt das Relais etwa 7 – 10 Sekunden bis zum Aktivieren. Anschließend die Polarität der Trockenbatterien umpolen und die obige Prüfung des Relais nochmals durchführen. Wenn auch nun das Relais aktiviert wird, dann ist die Lautsprecher-Schutzschaltung in Ordnung. Bei dieser Prüfung ist besonders darauf zu achten, daß keine der benachbarten Teile kurzgeschlossen werden. Wird das Relais dadurch erregt, bedeutet es daß die Schutzschaltkreise der Lautsprecher normal funktionieren. Wenn diese Funktionsprüfung vorgenommen wird, darauf achten, daß keine Kurzschlüsse mit naheliegenden Teilen entstehen.

• Ursachen für das Ansprechen der Schutzschaltung und etwaige Abhilfen

	Schutzschaltung	Wirkung, wenn die Schutzschaltung anspricht	Ursache	Abhilfe
1	Muting- Schaltkreis	Kein Ton von den Lautsprechern bis etwa 7 bis 10 Sekunden nach dem Einschalten des Netzschalters.	_____	Normal
2	Schutzstromkreis für die Ausgangstransistoren.	1. Kein Ton. 2. Nachdem der Netzschalter eingeschaltet wurde, spricht das Relais an, es wird wieder angeschaltet, sobald ein Signal eingegeben wird.	Kurzschluß an den Lautsprecherklemmen	Netzschalter abschalten, auf Kurzschluß an den Lautsprecherklemmen achten und diesen ggf. beheben, danach wieder einschalten.
3	Lautsprecher-Schutzschaltung	1. Kein Ton. 2. Nullpunktspannung beträgt mehr als ± 2 V 3. Wenn der Netzschalter eingeschaltet wird, spricht das Relais nicht an.	Endstufe schadhaft usw.	Die schadhaften Teile der Endstufe reparieren.

CONTRÔLE DE FONCTIONNEMENT DU CIRCUIT DE PROTECTION

Quand le circuit de sortie est réparé à la suite du remplacement des transistors de sortie, etc., effectuer une vérification de fonctionnement du circuit de détection ASO (Zone d'Opération Protégée) pour transistors de sortie et du circuit de protection de haut-parleur.

1. Contrôle de fonctionnement du circuit de détection ASO pour les transistors de sortie

Brancher un oscillateur d'onde sonore aux bornes TUNER IN quand aucune charge n'est appliquée aux bornes de haut-parleur (haut-parleur débranché). Régler la fréquence de l'oscillateur d'onde sonore à 1 kHz et ajuster le niveau du signal d'entrée de telle sorte que la tension appliquée aux bornes de haut-parleur soit environ de 5 V efficace. Quand ces conditions sont obtenues, court-circuiter les bornes de haut-parleur du canal recevant le signal d'entrée en se servant d'un fil de jonction, etc. Si le court-circuit met le circuit de détection de type ASO en fonction, aucune sortie n'est relevée aux bornes de haut-parleur même si le fil de jonction utilisé pour le court-circuitage est retiré.

Ensuite, mettre l'interrupteur général à l'arrêt et après un délais approximatif de 10 secondes, le mettre à nouveau en fonction. Quand la sortie parvient aux bornes de haut-parleur, c'est le signe que le circuit de détection de type ASO fonctionne normalement.

2. Contrôle de fonctionnement du circuit de protection de haut-parleur

S'assurer que le relais fonctionne (un déclic se produit) environ 7 – 10 secondes après la mise en fonction de l'interrupteur général quand les bornes de haut-parleur ne reçoivent aucune charge (haut-parleur débranché). Lorsqu'une résistance d'environ 10 kilohms et deux piles de 1,5 V sont connectées en série aux broches 5 et 2 de la plaquette imprimée IC901 d'ampli principal, le relais se met hors fonction en moins d'une seconde. Si l'alimentation est rétablie au moins 10 secondes plus tard, il faut au relais 7 – 10 secondes pour se réenclencher.

Ensuite, modifier les polarités des piles sèches et procéder au contrôle précédemment décrit pour s'assurer que le fonctionnement du relais est normal. Si ces conditions permettent au relais de se mettre en fonction, cela veut dire que le circuit de protection de haut-parleur fonctionne normalement. Par ailleurs, faire attention de ne pas court-circuiter les pièces et composants avoisinants au cours de ce contrôle.

Si le relai est énergétisé par cette opération, c'est la preuve que les circuits de protection des enceintes fonctionnent normalement.

Lorsque l'on procède à cet essai de fonctionnement, prendre soin à ne pas provoquer un court-circuit avec les pièces voisines.

• Phénomène et remède à apporter quand le circuit de protection est mis en fonction.

	Type de circuit de protection	Phénomène produit quand le circuit de protection est mis en fonction.	Cause	Remède
1	Circuit de réglage silencieux	Aucun son n'est obtenu pendant 7 – 10 secondes après la mise en fonction de l'interrupteur d'alimentation.	_____	Condition normale
2	Circuit de protection des transistors de sortie.	1. Aucun son n'est obtenu. 2. Dès que l'interrupteur général est réglé sur ON, le relais est mis sous tension puis est mis à l'arrêt quand le signal est appliqué.	Court-circuit des bornes de sortie d'enceinte	Mettre l'interrupteur général à l'arrêt, s'assurer que les bornes d'enceinte ne sont pas court-circuitées et remettre sous tension.
3	Circuit de protection d'enceinte	1. Aucun son n'est obtenu. 2. La tension de masse est supérieure à ± 2 V. 3. Dès que l'interrupteur général est réglé sur ON, le relais n'est pas mis sous tension.	Panne d'ampli de puissance, etc.	Reparer les pièces endommagées de l'ampli de puissance.

DESCRIPTION OF NEW CIRCUIT • BESCHREIBUNG DES NEUEN SCHALTKREISES • DESCRIPTION DES NOUVEAUX CIRCUITS

Design of SURROUND circuit

Several designs are available today for this circuit: delay type, speaker matrix type and Dolby surround type, among others. The SURROUND circuit of the HA-D100 is of phase type, as shown in the block diagram given below. In this phase-type SURROUND circuit, "L" and "R" are combined in the mixing circuit (IC603), and the mixed signal is delayed in the phase shifter circuit (IC604, 605) before it is fed again as L/R signal into the line.

While the delayed signal is amplified and sent out, it is again retracted from the speaker matrix composed of rear speakers. The retracted signal is used to reproduce sound for SURROUND effect.

The circuit is arranged to include simulated stereo sound reproduction with a monaural signal input. Thus, even with such a signal, SURROUND effect is available.

Konzeption der SURROUND-Schaltung

Diese Schaltung gibt es houtzutage in mehreren Ausführungen: Verzögerungstyp, Lautsprechermatrixtyp, Dolby-Surround-Trp u.a. Bei der SURROUND-Schaltung des HA-D100 handelt es sich um einen Phasentyp. Siehe Blockschaltbild unten.

Bei dieser Phasen-SURROUND-Schaltung werden "L" und "R" in der Mischschaltung (IC603) kombiniert, und das Mischsignal wird in der Phasenverschiebungsschaltung (IC604, 605) verzögert, bevor es wieder als L/R-Signal eingespeist wird.

Während das verzögerte Signal verstärkt und ausgegeben wird, wird es erneut von der aus den hinteren Lautsprechern

bestehenden Lautsprechermatrix zurückgeführt. Das zurückgeführte Signal dient zur Wiedergabe des Klangs für SURROUND-Effekt.

Diese Schaltung umfaßt simulierte Stereo-Klangwiedergabe mit Mono-Signaleingang, so daß auch in diesem Fall SURROUND-Effekt zur Verfügung steht.

Conception du circuit SURROUND (ambiphonique)

il existe actuellement plusieurs types de conception de ce circuit: à retard, à matrice de haut-parleur et enveloppant type Dolby parmi les plus connus. Le circuit SURROUND du modèle HA-D100 est du type à phase, comme représenté sur le diagramme synoptique qui apparalt plus loin.

Avec ce circuit SURROUND de type à phase, les canaux "L" (gauche) et "R" (droit) sont fusionnés dans un circuit mélangeur (IC603) et le signal mélangé qui est obtenu est retardé dans le circuit déphaseur (IC604, 605) avant d'être injecté à nouveau dans le circuit sous la formm d'un signal L/R.

Alors que le signal retardé est amplifié et délivré, il est à nouveau restauré par le circuit à matrice de haut-parleur des haut-parleurs arrière. Le signal restauré est alors employé pour la reproduction acoustiqué en qualité d'effet SURROUND.

Le circuit SURROUND est constitué de telle façon qu'il puisse assurer une reproduction acoustique stéréo simulée à partir d'une entrée de signal monaural. On peut en conclure qu'un tel signal permet également de parvenir à l'effet SURROUND recherché.

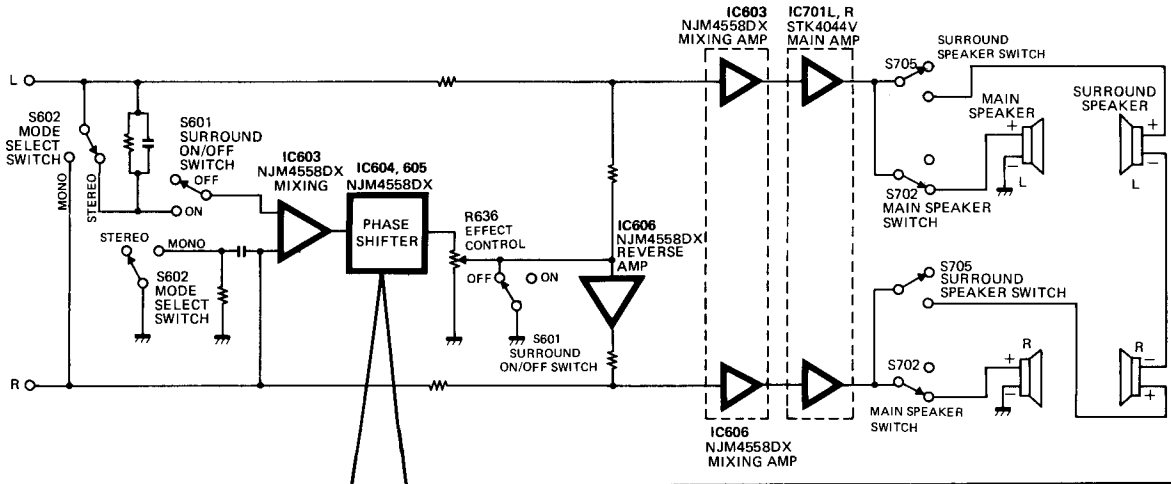

Basic phase shifter circuit

This circuit is a sort of active filter. The absolute value of the degree of amplification is constant in this circuit; only the phase rotates at a certain frequency acting as a dividing line. Four stages of phase shifting constitute this circuit in the HA-D100.

Grundphasenverschiebungsschaltung

Bei dieser Schaltung handelt es sich um eine Art Aktivfilter. Der absolute Wert des Verstärkungsgrads ist in dieser Schaltung konstant. Nur die Phase dreht sich bei einer gewissen Frequenz, die als Trennlinie dient. Vier Phasenverschiebungsstufen bilden diese Schaltung im HA-D100.

Circuit déphaseur fondamental

Ce circuit est en quelque sorte un filtre actif. La valeur absolue du taux d'amplification est constants dans ce circuit: seule une rotation de phase se produit à une fréquence déterminée jouant ainsi le role de ligne de division. Quatre étages de déphasage composent ce circuit dans le modèle HA-D100.

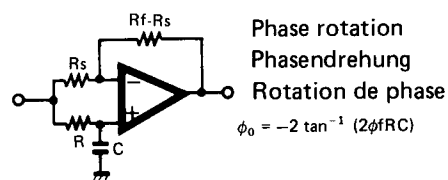

Phase rotation
Phasendrehung
Rotation de phase
 $\phi_0 = -2 \tan^{-1} (2\phi RC)$

How to check SURROUND effect

Feed a sinusoidal signal to, say, "AUX" and turn "SURROUND" on and off alternately while observing the waveform of the output signal available from the speaker output terminal.

Überprüfen des SURROUND-Effekts

Ein sinusförmiges Signal beispielsweise "AUX" zuführen und "SURROUND" abwechselnd ein-und ausschalten, während die Wellenform des Ausgangssignals am Lautsprecherausgang beobachtet wird.

Comment vérifier si l'effet SURROUND est appliqué

Injecter un signal sinusoidal, disons par "AUX" puis appliquer et couper alternativement le circuit SURROUND tout en observant l'oscillogramme obtenu du signal de sortie présent aux bornes de haut-parleur.

Connect X-axis probe to L output end.
X-Achsen-Sonde an L-Ausgangsende anschließen.
Brancher la sonde de l'axe des X à la sortie L.

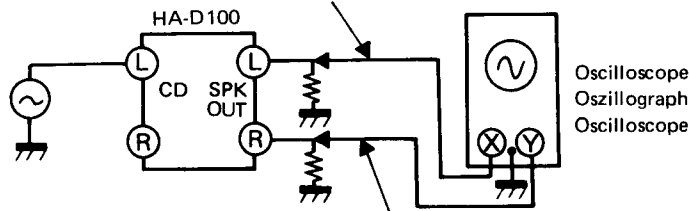

Connect Y-axis probe to L output end.
Y-Achsen-Sonde an L-Ausgangsende anschließen.
Brancher la sonde de l'axe des Y à la sortie L.

**SURROUND ON
SURROUND EIN
SURROUND en fonction**

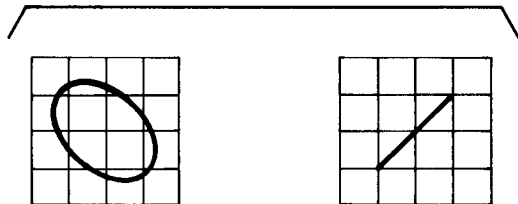

"L" or "R" input
"L"-ODER "R"-EINGANG
Entrée "L" ou "R"

L/R input
L/R-EINGANG
Entrée L/R

**SURROUND OFF
SURROUND AUS
SURROUND hors service**

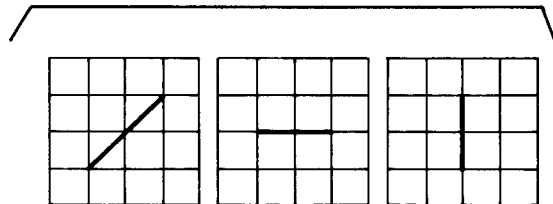

L/R input
L/R-EINGANG
Entrée L/R

L input
L-EINGANG
Entrée L

R input
R-EINGANG
Entrée R

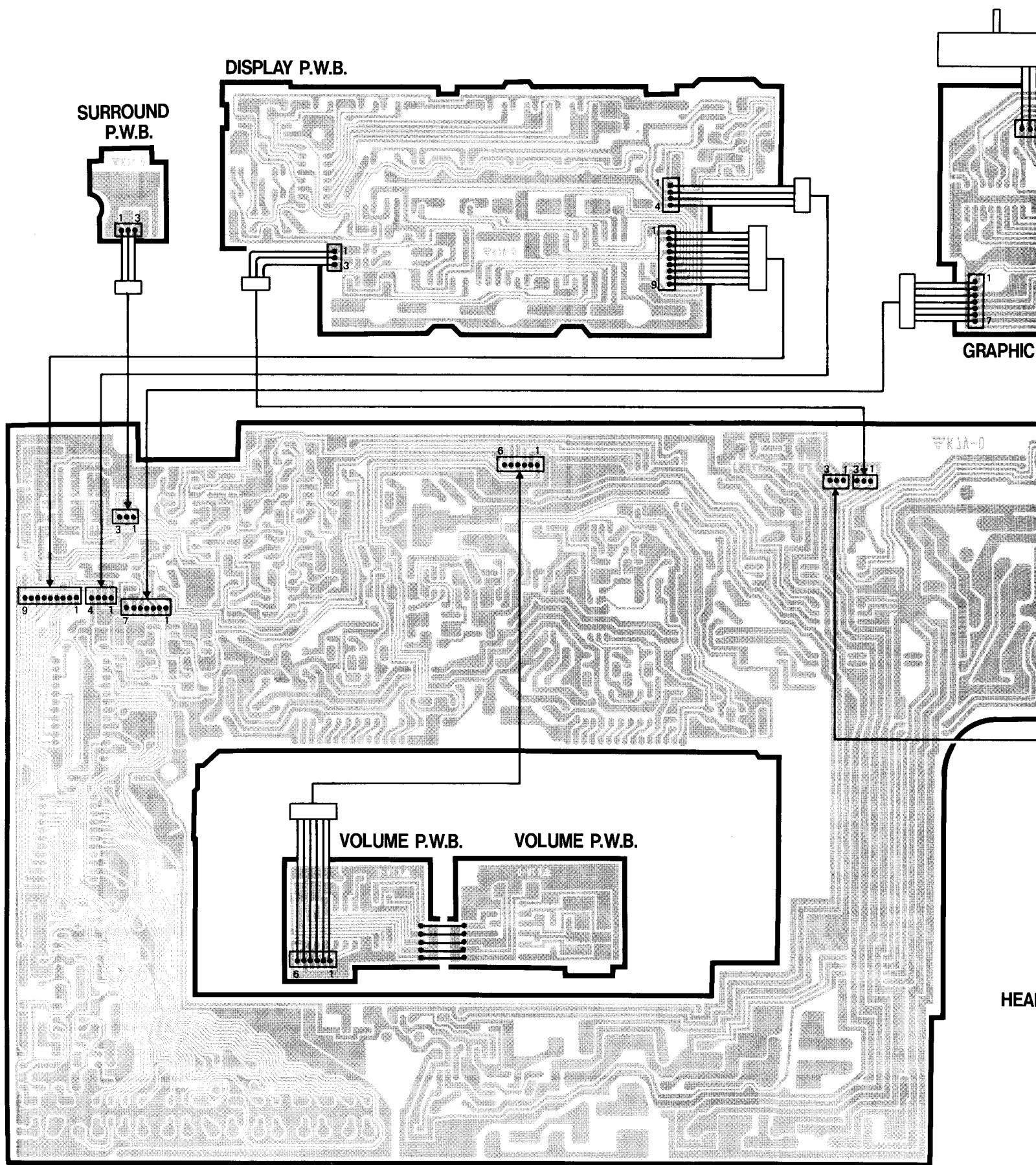

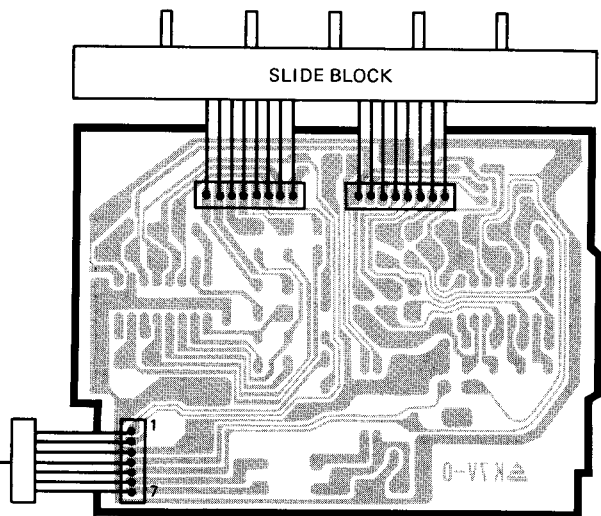

GRAPHIC EQUALIZER P.W.B.

AD P.W.B.

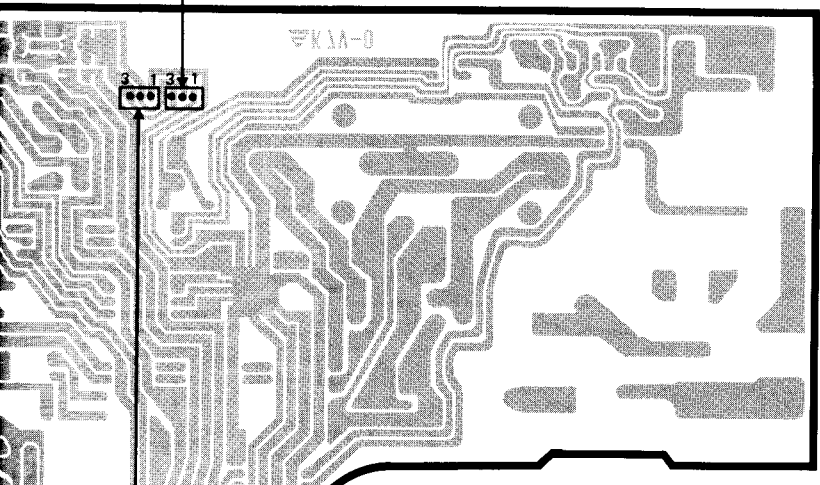

HEADPHONES P.W.B.

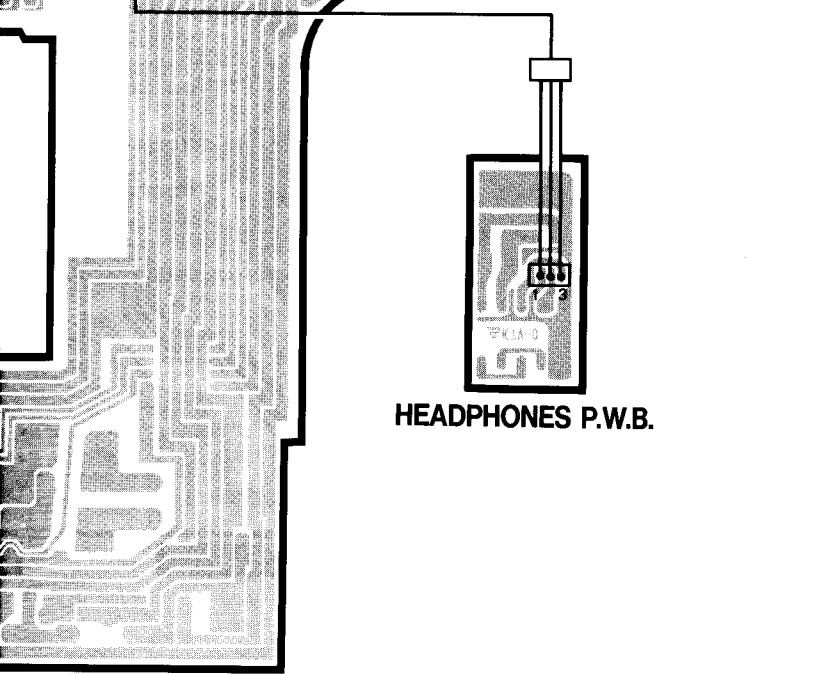

For SA, BS, ZS, KS, VS, ES

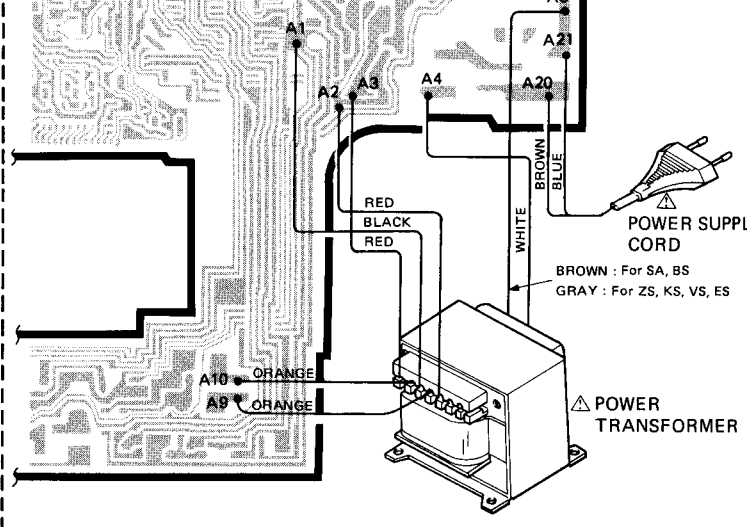

For US, CS

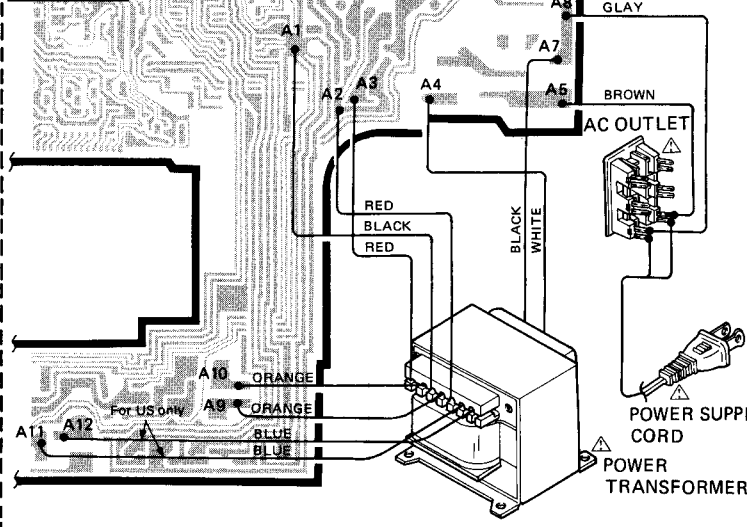

For EW

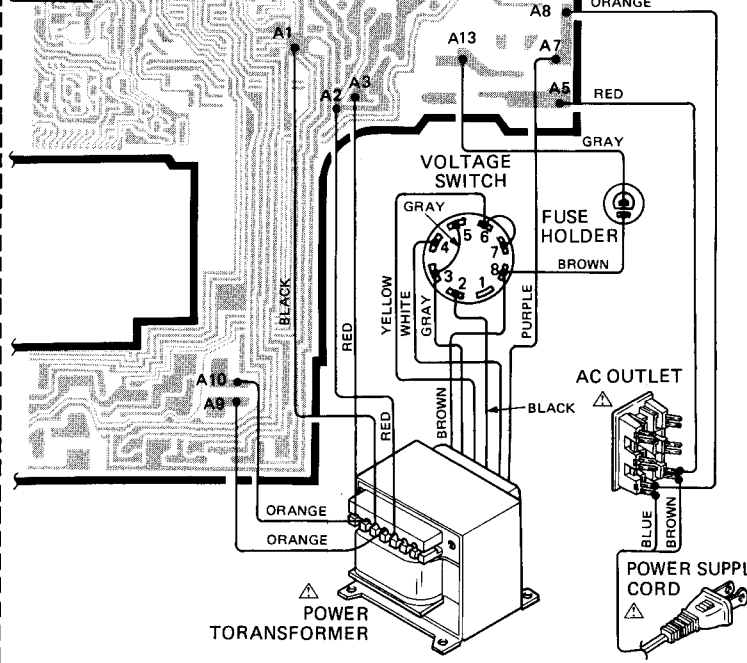

AD P.W.B.

INPUT JACK

INPUT JACK

AC SOCKET

SPEAK

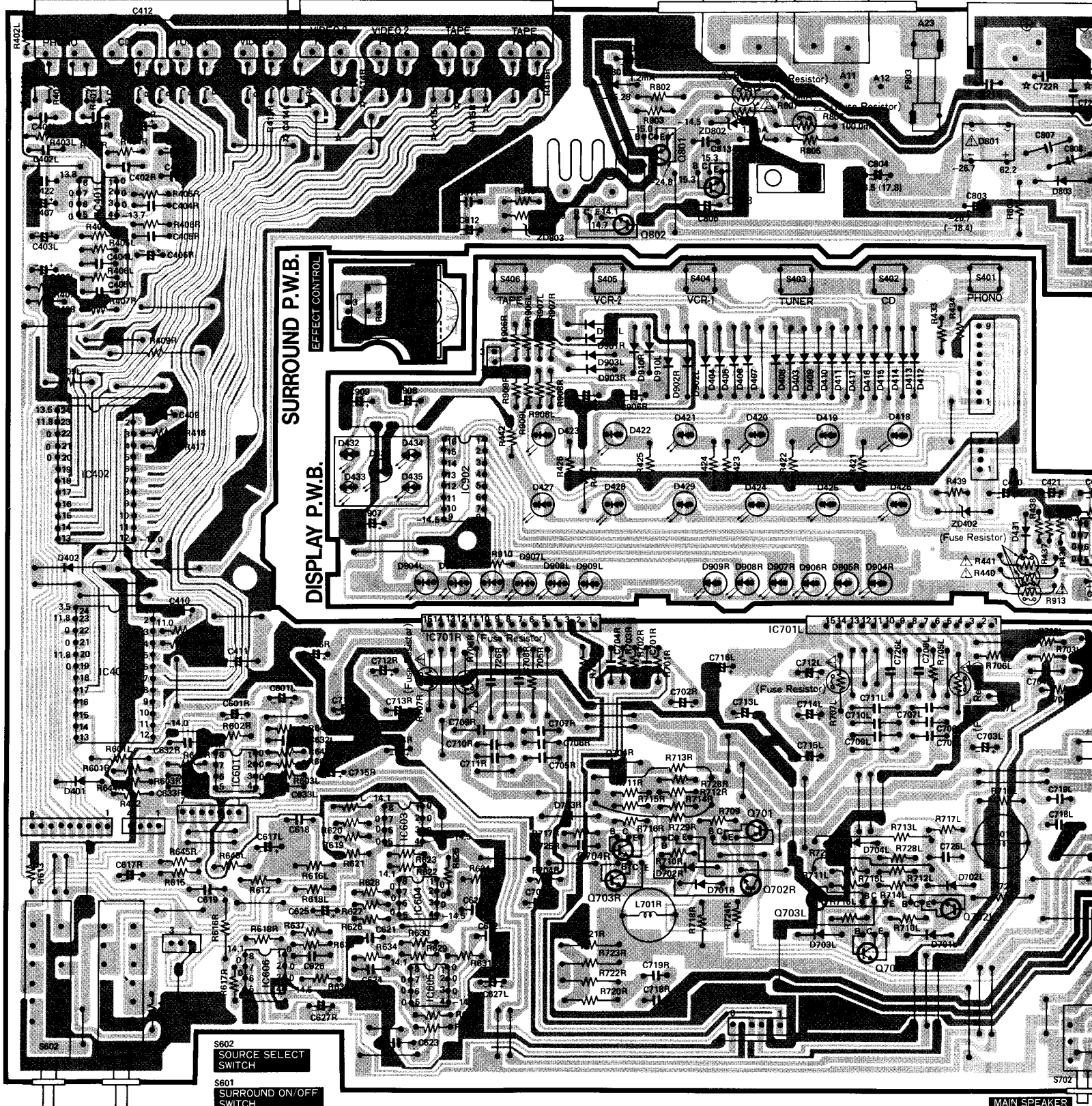

S602
SOURCE SELECT
SWITCH

S601
SURROUND ON/OFF
SWITCH

S702
MAIN SPEAKER
SWITCH

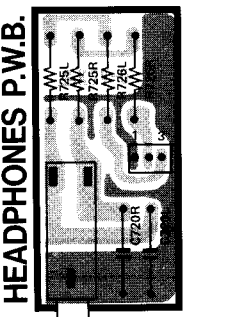
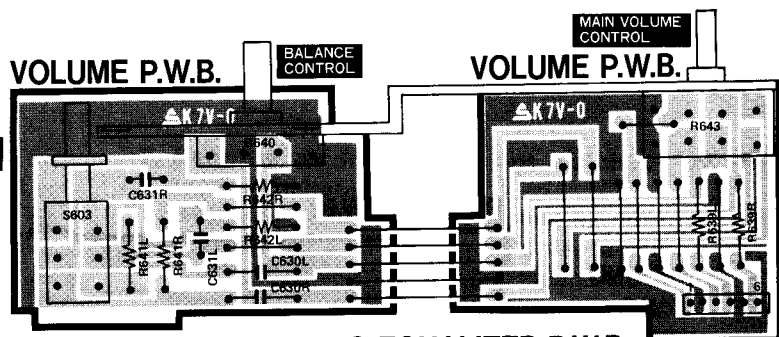
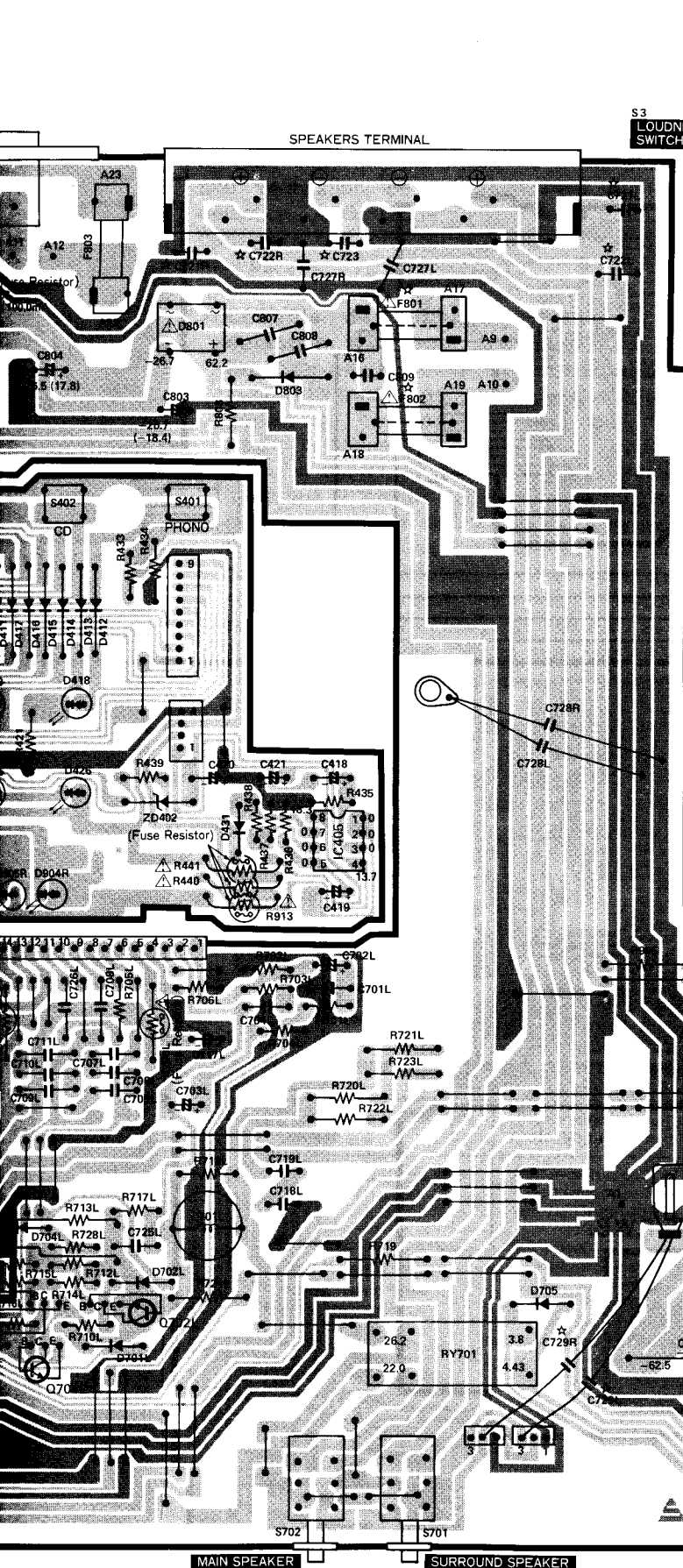

IC701L, R

Pin No.	Voltage
1	-0.35
2	-0.35
3	0
4	-59.3
5	-61.0
6	
7	11.1
8	60.0
9	-1.3
10	-1.3
11	61.0
12	-62.3
13	-4.0m
14	62.3
15	61.1

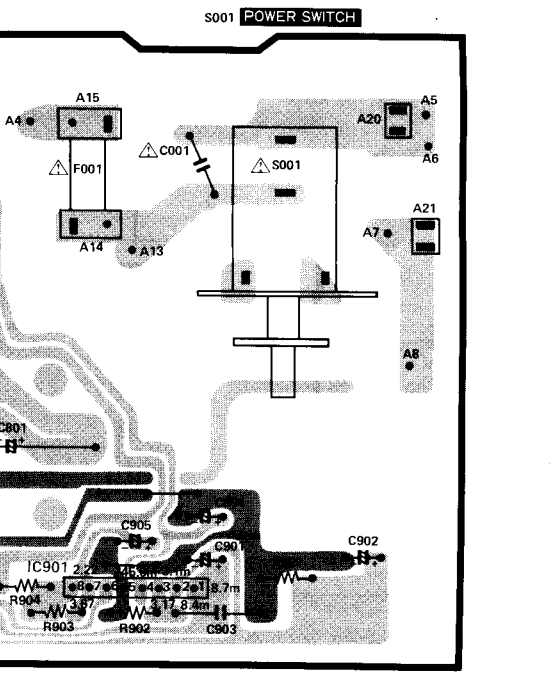
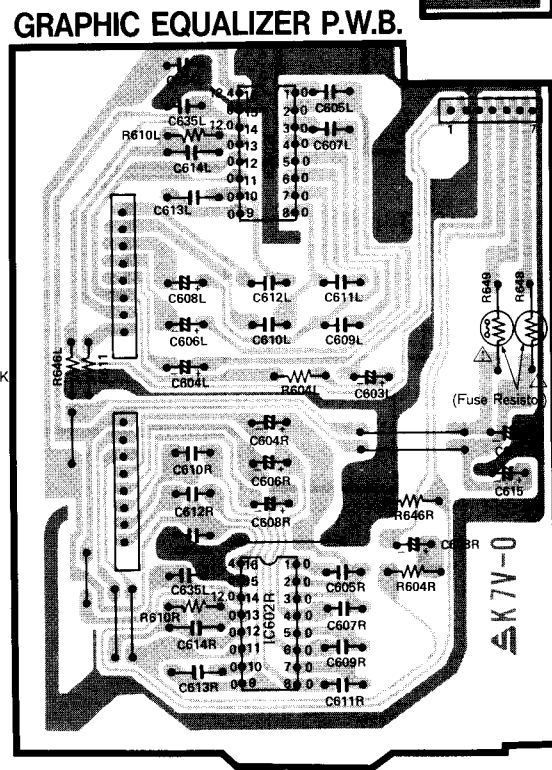

CIRCUIT DIAGRAM · SCHALTPLAN · PLAN DE CIRCUIT (HA-D100)

AD P.W.B.

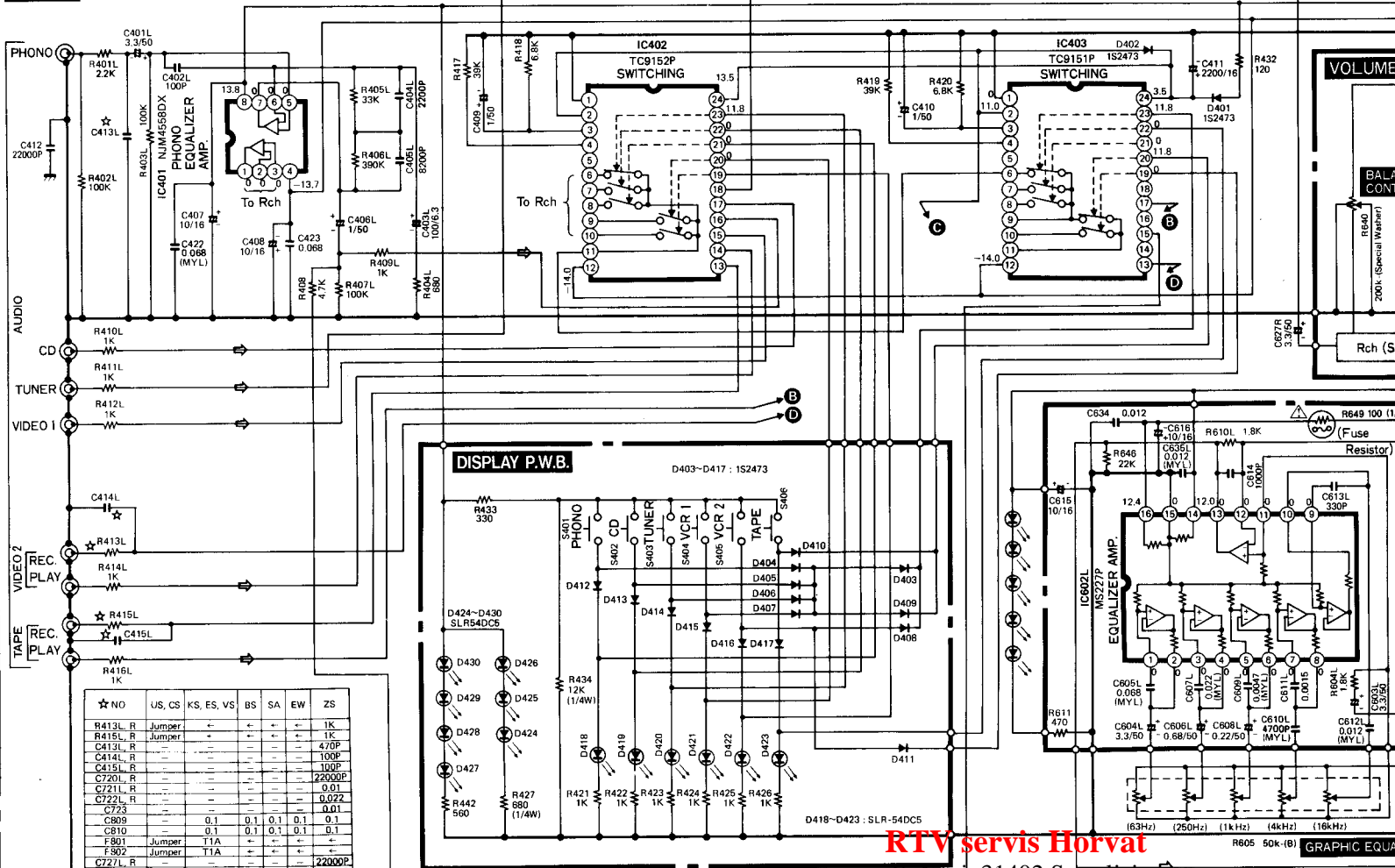

★ NO	US	CS	KS	ES	VS	BS	SA	EW	ZS
R413L R	Jumper	+	+	+	+	+	+	+	1K
R415L R	Jumper	+	+	+	+	+	+	+	1K
C413L R									470P
C414L R									100P
C415L R									100P
C720L R									22000P
C721L R									0.01
C722L R									0.022
C723 R									0.01
C809			0.1	0.1	0.1	0.1	0.1	0.1	
C810			0.1	0.1	0.1	0.1	0.1	0.1	
F801	Jumper	T1A	+	+	+	+	+	+	
F902	Jumper	T1A	+	+	+	+	+	+	
C727L R									22000P
C728L R									22000P
C729L R									10000P

RTV servis Horvat

Kesinac, 31402 Semeljci

031-856-139

031-856-637

098-788-319

rtv-servis-horvat@os.tel.hr

Croatia

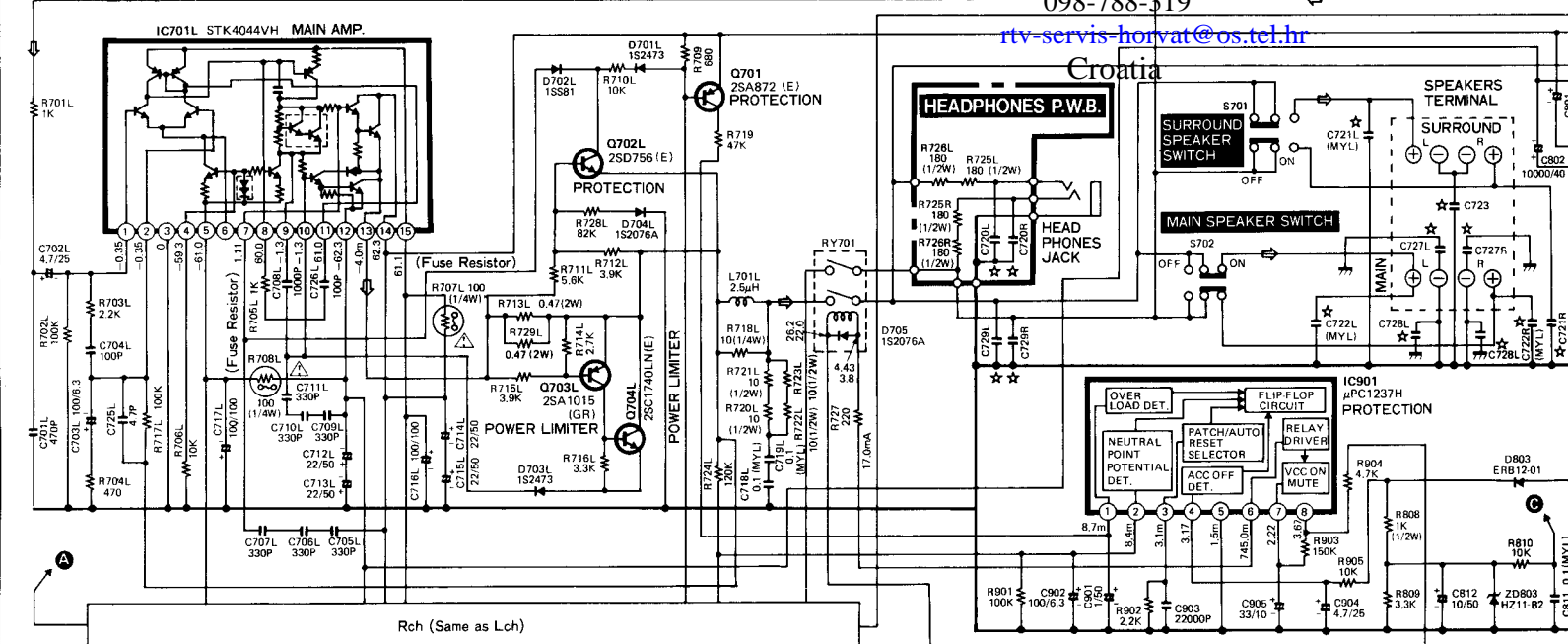

Rch (Same as Lch)

The circuit symbol (☆) means difference for destination.
 Das Schaltsymbol (☆) deutet Unterscheidung gegen Bestimmungsort.
 Le symbole de circuit (☆) signifie qu'il s'agit des différence pour destination.

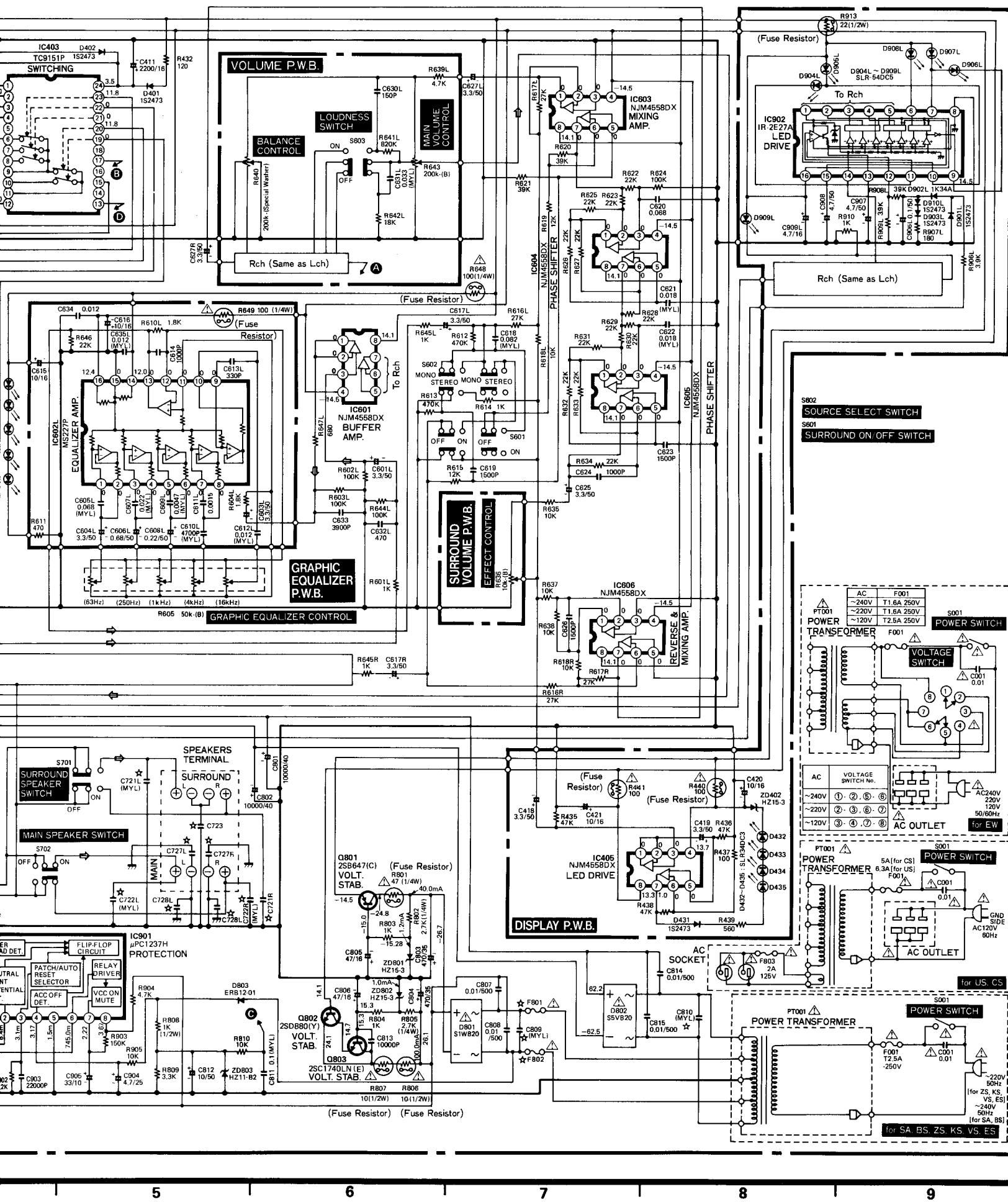

FM ANT. (75Ω)
(DIN COAXIAL)
SOKET
except US, CS

FM ANT. (75Ω)
for US, CS

GND

LOOP
ANT.

AM EXT.
ANT.

AUDIO
OUTPUT

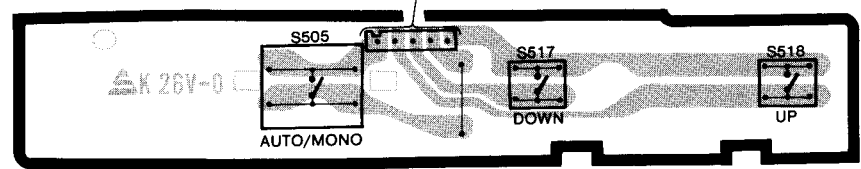
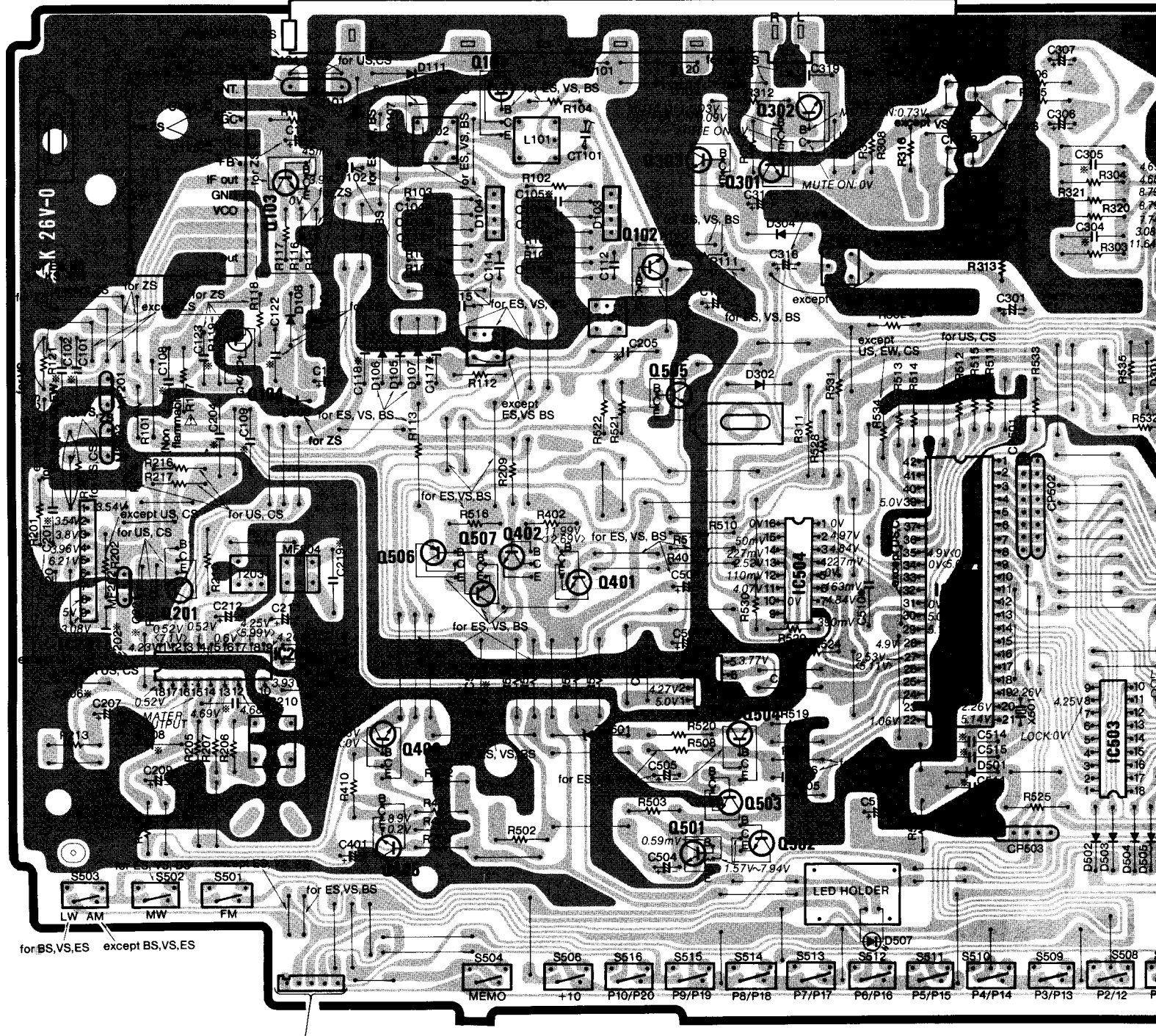

US : U.S.A.
 CS : Canada
 EW : Asia & Latin American countries, etc.
 BS : U.K.
 VS : Switzerland
 KS : Sweden
 ES : France
 SA : Australia
 ZS : W.Germany

(FT-D100)

[██████]: Earth, [██████]: Others

※ Axial lead cylindrical ceramic capacitor
※ Zylindrischer Keramik Kondensator mit axialer Zuleitung
※ Condensateur céramique cylindrique à conducteur axial

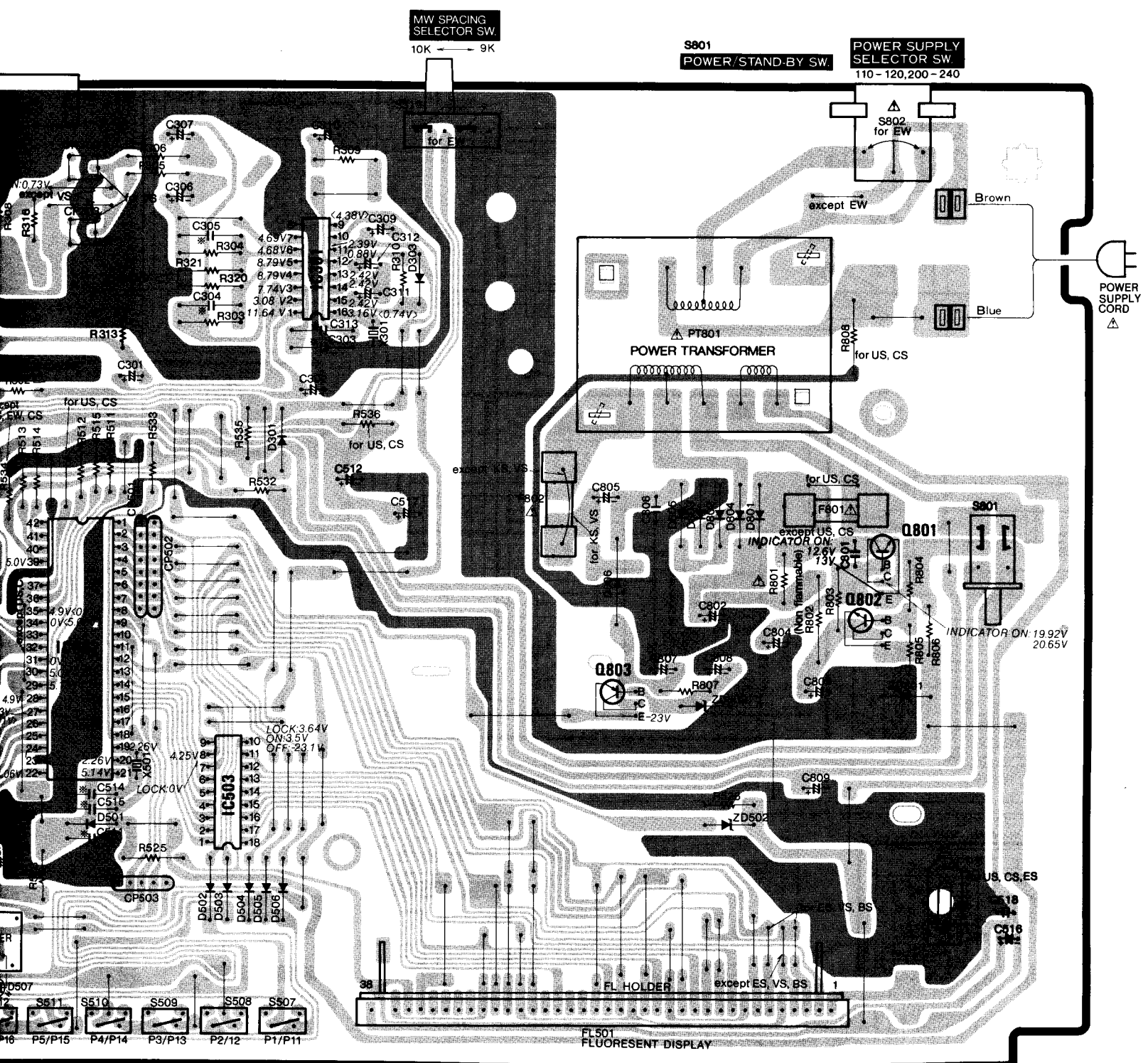

TUNER P.W.B.

CIRCUIT DIAGRAM · SCHALTPLAN · PLAN DE CIRCUIT (FT-D100)

✖A
✖Z
✖C

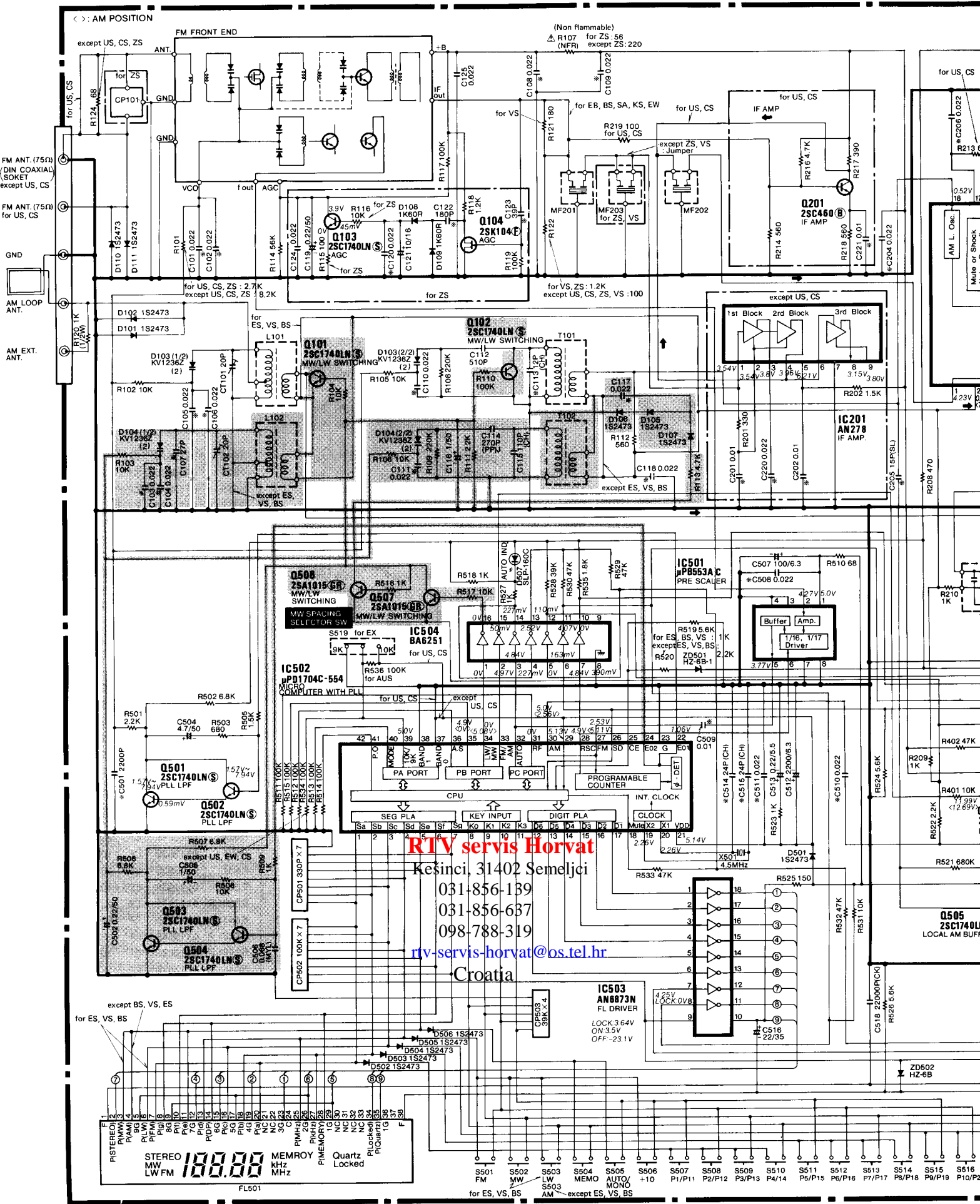

RTV servis Horvat
 Kešinci, 31402 Semeljci
 031-856-139
 031-856-637
 098-788-319
rtv-servis-horvat@os.tel.hr
 Croatia

BLOCK DIAGRAM · BLOCKSCHEMA · SCHEMA
HA-D100

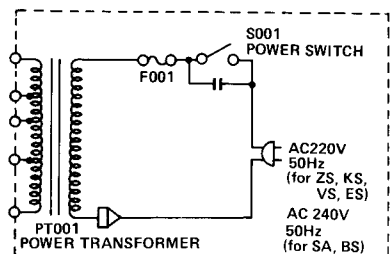
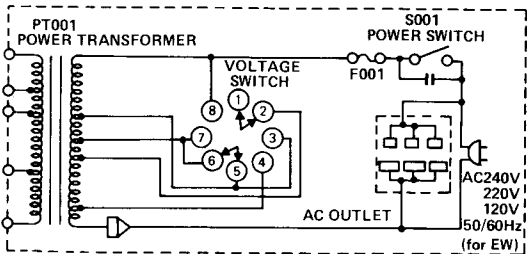
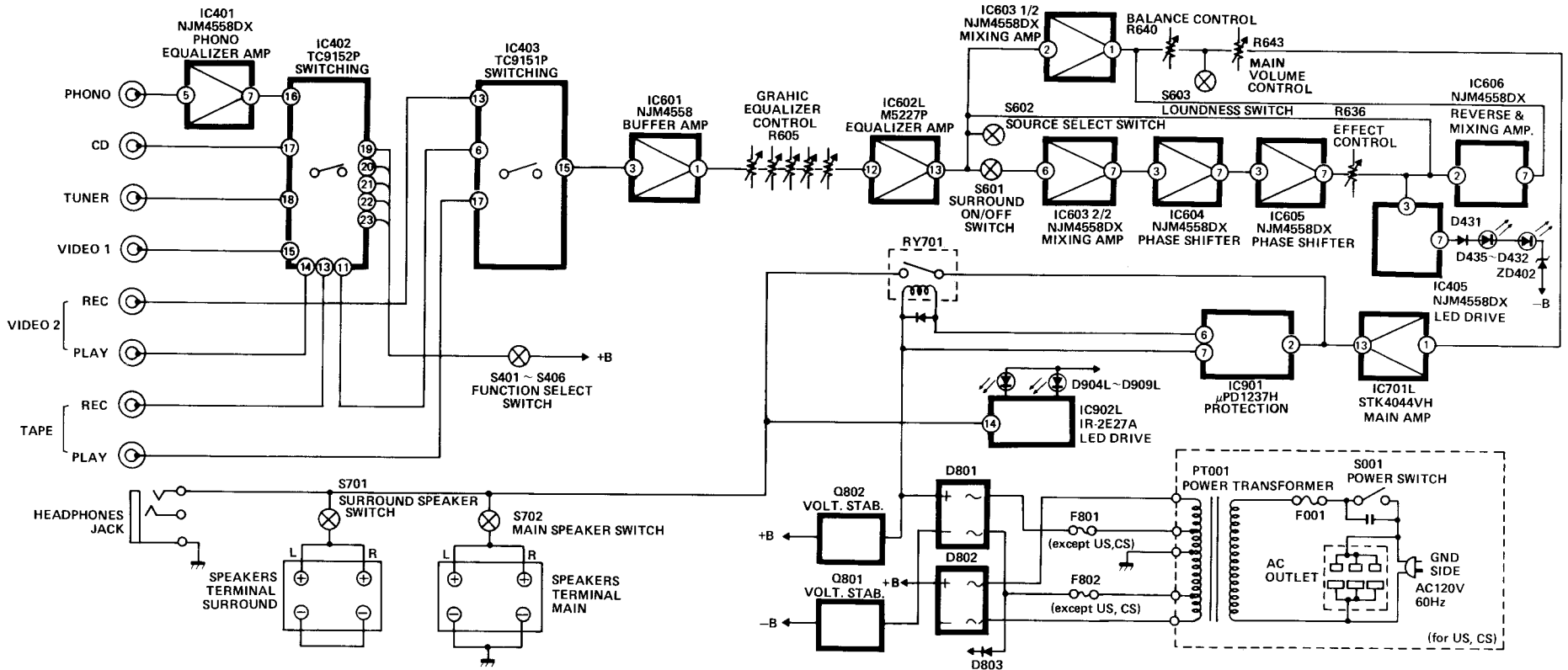

RTV servis Horvat

Kešinci, 31402 Semeljci

031-856-139

031-856-637

098-788-319

rtv-servis-horvat@os.tel.hr

Croatia

EL : Electrolytic CD : Ceramic discal CF : Carbon film ME : Metal
 CC : Cylindrical ceramic ST : Styrol NF : Non flammable SC : Super capacitor
 MF : Mylar film PP : Polypro-pylene FR : Fuse resistor

HA-D100

SYMBOL NO.	PART NO.	DESCRIPTION		
CAPACITORS				
C001	1243901	CD	0.01 μ F	$\pm 100\%$ -0% 400V
C401LR	0252813	EL	3.3 μ F	$\pm 20\%$ 50V
C403LR	0252231	EL	100 μ F	$\pm 20\%$ 6.3V
C406LR	0252811	EL	1 μ F	$\pm 20\%$ 50V
C407	0252521	EL	10 μ F	$\pm 20\%$ 16V
C408	0252521	EL	10 μ F	$\pm 20\%$ 16V
C409	0252811	EL	1 μ F	$\pm 20\%$ 50V
C410	0252811	EL	1 μ F	$\pm 20\%$ 50V
C411	1252542	EL	2200 μ F	$\pm 20\%$ 16V
C418	0252813	EL	3.3 μ F	$\pm 20\%$ 50V
C419	0252813	EL	3.3 μ F	$\pm 20\%$ 50V
C420	0252521	EL	10 μ F	$\pm 20\%$ 16V
C421	0252521	EL	10 μ F	$\pm 20\%$ 16V
C422	0275016	MF	0.068 μ F	$\pm 10\%$ 50V
C423	0275016	MF	0.068 μ F	$\pm 10\%$ 50V
C601LR	0252813	EL	3.3 μ F	$\pm 20\%$ 50V
C603LR	0252813	EL	3.3 μ F	$\pm 20\%$ 50V
C604LR	0252813	EL	3.3 μ F	$\pm 20\%$ 50V
C605LR	0275016	MF	0.068 μ F	$\pm 10\%$ 50V
C606LR	0252807	EL	0.68 μ F	$\pm 20\%$ 50V
C607LR	0275013	MF	0.022 μ F	$\pm 10\%$ 50V
C608LR	0252802	EL	0.22 μ F	$\pm 20\%$ 50V
C609LR	0274015	MF	4700PF	$\pm 10\%$ 50V
C610LR	0275015	MF	4700PF	$\pm 10\%$ 50V
C611LR	0274012	PP	0.0015 μ F	$\pm 10\%$ 50V
C612LR	0275031	MF	0.012 μ F	$\pm 10\%$ 50V
C613LR	0240039	CD	330PF	$\pm 10\%$ 50V
C614LR	0240045	CD	1000PF	$\pm 10\%$ 50V
C615	0252521	EL	10 μ F	$\pm 20\%$ 16V
C616	0252521	EL	10 μ F	$\pm 20\%$ 16V
C617LR	0252813	EL	3.3 μ F	$\pm 20\%$ 50V
C618	0275036	MF	0.082 μ F	$\pm 10\%$ 50V
C620	0275016	MF	0.068 μ F	$\pm 10\%$ 50V
C621	0275032	MF	0.018 μ F	$\pm 10\%$ 50V
C622	0275032	MF	0.018 μ F	$\pm 10\%$ 50V
C625	0252813	EL	3.3 μ F	$\pm 20\%$ 50V
C627LR	0252813	EL	3.3 μ F	$\pm 20\%$ 50V
C630LR	0240035	CD	150PF	$\pm 10\%$ 50V
C631LR	0275014	MF	0.033 μ F	$\pm 10\%$ 50V
C634LR	0275031	MF	0.012 μ F	$\pm 10\%$ 50V
C635LR	0275031	MF	0.012 μ F	$\pm 10\%$ 50V
C702LR	0252615	EL	4.7 μ F	$\pm 20\%$ 25V
C703LR	0252231	EL	100 μ F	$\pm 20\%$ 6.3V
C712LR	0252822	EL	22 μ F	$\pm 20\%$ 50V
C713LR	0252822	EL	22 μ F	$\pm 20\%$ 50V
C714LR	0252822	EL	22 μ F	$\pm 20\%$ 50V
C715LR	0252822	EL	22 μ F	$\pm 20\%$ 50V
C716LR	1253031	EL	100 μ F	$\pm 20\%$ 100V
C717LR	1253031	EL	100 μ F	$\pm 20\%$ 100V
C718LR	0276011	MF	0.1 μ F	$\pm 10\%$ 50V
C719LR	0276011	MF	0.1 μ F	$\pm 10\%$ 50V
C720LR	0240108	CD	0.022 μ F	$\pm 30\%$ 16V [for ZS]
C721LR	0275011	MF	0.01 μ F	$\pm 10\%$ 50V [for ZS]
C722LR	0275013	MF	0.022 μ F	$\pm 10\%$ 50V [for ZS]
C723	0275011	MF	0.01 μ F	$\pm 10\%$ 50V [for ZS]

SYMBOL NO.	PART NO.	DESCRIPTION		
C727LR	0244173	CD	0.022 μ F	$\pm 80\%$ -20% 50V [for ZS]
C728LR	0244173	CD	0.022 μ F	$\pm 80\%$ -20% 50V [for ZS]
C729LR	0244171	CD	0.01 μ F	$\pm 80\%$ -20% 50V [for ZS]
C801	0259986	EL	0.01F	$\pm 20\%$ 40V
C802	0259986	EL	0.01F	$\pm 20\%$ 40V
C803	1252735	EL	470 μ F	$\pm 20\%$ 35V
C804	1252735	EL	470 μ F	$\pm 20\%$ 35V
C805	0252525	EL	47 μ F	$\pm 20\%$ 16V
C806	0252525	EL	47 μ F	$\pm 20\%$ 16V
C807	0245408	CD	0.01 μ F	$\pm 20\%$ 500V
C808	0245408	CD	0.01 μ F	$\pm 20\%$ 500V
C809	1276511	MF	0.1 μ F	$\pm 10\%$ 100V [except CS, US]
C810	1276511	MF	0.1 μ F	$\pm 10\%$ 100V [except CS, US]
C811	0276011	MF	0.1 μ F	$\pm 10\%$ 50V
C812	0252821	EL	10PF	$\pm 20\%$ 50V
C813	0244171	CD	0.01 μ F	$\pm 80\%$ -20% 50V
C814	0245408	CD	0.01 μ F	$\pm 20\%$ 500V
C815	0245408	CD	0.01 μ F	$\pm 20\%$ 500V
C901	0252811	EL	1 μ F	$\pm 20\%$ 50V
C902	0252231	EL	100 μ F	$\pm 20\%$ 6.3V
C904	0252615	EL	4.7 μ F	$\pm 20\%$ 25V
C905	0252323	EL	33 μ F	$\pm 20\%$ 10V
C906LR	0252801	EL	0.1 μ F	$\pm 20\%$ 50V
C907	0252815	EL	4.7 μ F	$\pm 20\%$ 50V
C908	0252815	EL	4.7 μ F	$\pm 20\%$ 50V
C909	0252525	EL	47 μ F	$\pm 20\%$ 16V
RESISTORS				
R001	0139005	RC	2.7M Ω	$\pm 10\%$ RN1/2B
R401LR	0113623	CF	2.2k Ω	$\pm 5\%$ SRD1/6P
R402LR	0113663	CF	100k Ω	$\pm 5\%$ SRD1/6P
R403LR	0113663	CF	100k Ω	$\pm 5\%$ SRD1/6P
R404LR	0113611	CF	680 Ω	$\pm 5\%$ SRD1/6P
R405LR	0113651	CF	33k Ω	$\pm 5\%$ SRD1/6P
R406LR	0113677	CF	390k Ω	$\pm 5\%$ SRD1/6P
R407LR	0113663	CF	100k Ω	$\pm 5\%$ SRD1/6P
R408	0113631	CF	4.7k Ω	$\pm 5\%$ SRD1/6P
R409LR	0113615	CF	1k Ω	$\pm 5\%$ SRD1/6P
R410LR	0113615	CF	1k Ω	$\pm 5\%$ SRD1/6P
R411LR	0113615	CF	1k Ω	$\pm 5\%$ SRD1/6P
R412LR	0113615	CF	1k Ω	$\pm 5\%$ SRD1/6P
R413LR	0113615	CF	1k Ω	$\pm 5\%$ SRD1/6P [for ZS]
R414LR	0113615	CF	1k Ω	$\pm 5\%$ SRD1/6P
R415LR	0113615	CF	1k Ω	$\pm 5\%$ SRD1/6P [for ZS]
R416LR	0113615	CF	1k Ω	$\pm 5\%$ SRD1/6P
R417	0113653	CF	39k Ω	$\pm 5\%$ SRD1/6P
R418	0113633	CF	5.6k Ω	$\pm 5\%$ SRD1/6P
R419	0113653	CF	39k Ω	$\pm 5\%$ SRD1/6P
R420	0113633	CF	5.6k Ω	$\pm 5\%$ SRD1/6P
R421	0113615	CF	1k Ω	$\pm 5\%$ SRD1/6P
R422	0113615	CF	1k Ω	$\pm 5\%$ SRD1/6P
R423	0113615	CF	1k Ω	$\pm 5\%$ SRD1/6P
R424	0113615	CF	1k Ω	$\pm 5\%$ SRD1/6P
R425	0113615	CF	1k Ω	$\pm 5\%$ SRD1/6P

SYMBOL NO.	PART NO.	DESCRIPTION		
R426	0113615	CF	1k Ω	$\pm 5\%$ SRD1/6P
R427	0129581	CF	680 Ω	$\pm 5\%$ SRD1/4P
R432	0113593	CF	120 Ω	$\pm 5\%$ SRD1/6P
R433	0113603	CF	330 Ω	$\pm 5\%$ SRD1/6P
R434	0129633	CF	12k Ω	$\pm 5\%$ SRD1/4P
R435	0113655	CF	47k Ω	$\pm 5\%$ SRD1/6P
R436	0113655	CF	47k Ω	$\pm 5\%$ SRD1/6P
R437	0113591	CF	100 Ω	$\pm 5\%$ SRD1/6P
R438	0113651	CF	33k Ω	$\pm 5\%$ SRD1/6P
R439	0113609	CF	560 Ω	$\pm 5\%$ SRD1/6P
R440	1110621	ME	100 Ω	$\pm 5\%$ SRD1/4P
R441	1110621	ME	100 Ω	$\pm 5\%$ SRD1/4P
R442	0113609	CF	560 Ω	$\pm 5\%$ SRD1/4P
R601LR	0113615	CF	1k Ω	$\pm 5\%$ SRD1/6P
R602LR	0113663	CF	100k Ω	$\pm 5\%$ SRD1/6P
R603LR	0113663	CF	100k Ω	$\pm 5\%$ SRD1/6P
R604LR	0113621	CF	1.8k Ω	$\pm 5\%$ SRD1/6P
R610LR	0113621	CF	1.8k Ω	$\pm 5\%$ SRD1/6P
R611	0113607	CF	470 Ω	$\pm 5\%$ SRD1/6P
R612	0113679	CF	470k Ω	$\pm 5\%$ SRD1/6P
R613	0113679	CF	470k Ω	$\pm 5\%$ SRD1/6P
R614	0113615	CF	1k Ω	$\pm 5\%$ SRD1/6P
R615	0113641	CF	12k Ω	$\pm 5\%$ SRD1/6P
R616LR	0113649	CF	27k Ω	$\pm 5\%$ SRD1/6P
R617LR	0113649	CF	27k Ω	$\pm 5\%$ SRD1/6P
R618LR	0113639	CF	10k Ω	$\pm 5\%$ SRD1/6P
R619	0113641	CF	12k Ω	$\pm 5\%$ SRD1/6P
R620	0113653	CF	39k Ω	$\pm 5\%$ SRD1/6P
R621	0113653	CF	39k Ω	$\pm 5\%$ SRD1/6P
R622	0113647	CF	22k Ω	$\pm 5\%$ SRD1/6P
R623	0113647	CF	22k Ω	$\pm 5\%$ SRD1/6P
R624	0113663	CF	100k Ω	$\pm 5\%$ SRD1/6P
R625	0113647	CF	22k Ω	$\pm 5\%$ SRD1/6P
R626	0113647	CF	22k Ω	$\pm 5\%$ SRD1/6P
R627	0113647	CF	22k Ω	$\pm 5\%$ SRD1/6P
R628	0113647	CF	22k Ω	$\pm 5\%$ SRD1/6P
R629	0113647	CF	22k Ω	$\pm 5\%$ SRD1/6P
R630	0113647	CF	22k Ω	$\pm 5\%$ SRD1/6P
R631	0113647	CF	22k Ω	$\pm 5\%$ SRD1/6P
R632	0113647	CF	22k Ω	$\pm 5\%$ SRD1/6P
R633	0113647	CF	22k Ω	$\pm 5\%$ SRD1/6P
R634	0113647	CF	22k Ω	$\pm 5\%$ SRD1/6P
R635	0113639	CF	10k Ω	$\pm 5\%$ SRD1/6P
R637	0113639	CF	10k Ω	$\pm 5\%$ SRD1/6P
R638	0113639	CF	10k Ω	$\pm 5\%$ SRD1/6P
R639LR	0113631	CF	4.7k Ω	$\pm 5\%$ SRD1/6P
R641LR	0113685	CF	820k Ω	$\pm 5\%$ SRD1/6P
R642LR	0113645	CF	18k Ω	$\pm 5\%$ SRD1/6P
R644LR	0113663	CF	100k Ω	$\pm 5\%$ SRD1/6P
R645LR	0113615	CF	1k Ω	$\pm 5\%$ SRD1/6P
R646LR	0113647	CF	22k Ω	$\pm 5\%$ SRD1/6P
R647LR	0113611	CF	680 Ω	$\pm 5\%$ SRD1/6P
Δ R648	1110621	FR	100 Ω	$\pm 5\%$ SRD1/4P
Δ R649	1110621	FR	100 Ω	$\pm 5\%$ SRD1/4P
R701LR	0113615	CF	1k Ω	$\pm 5\%$ SRD1/6P</

SYMBOL NO.	PART NO.	DESCRIPTION			
△R707LR	1110621	FR	100Ω	±5%	SRD1/4P
△R708LR	1110621	FR	100Ω	±5%	SRD1/4P
R709	0113611	CF	680Ω	±5%	SRD1/6P
R710LR	0113639	CF	10kΩ	±5%	SRD1/6P
R711LR	0113633	CF	5.6kΩ	±5%	SRD1/6P
R712LR	0113629	CF	3.9kΩ	±5%	SRD1/6P
R713LR	1119127	ME	0.47Ω	±10%	SRD2P
R714LR	0113625	CF	2.7kΩ	±5%	SRD1/6P
R715LR	0113629	CF	3.9kΩ	±5%	SRD1/6P
R716LR	0113627	CF	3.3kΩ	±5%	SRD1/6P
R717LR	0113663	CF	100kΩ	±5%	SRD1/6P
R718LR	0129531	CF	10Ω	±5%	SRD1/4P
R719	0113655	CF	47kΩ	±5%	SRD1/6P
R720LR	0113201	CF	10Ω	±5%	RN1/2B
R721LR	0113201	CF	10Ω	±5%	RN1/2B
R722LR	0113201	CF	10Ω	±5%	RN1/2B
R723LR	0113201	CF	10Ω	±5%	RN1/2B
R724LR	0113665	CF	120kΩ	±5%	SRD1/6P
R725LR	0113290	CF	180Ω	±5%	RN1/2B
R726LR	0113290	CF	180Ω	±5%	RN1/2B
R727	0113599	CF	220Ω	±5%	SRD1/6P
R728LR	0113661	CF	82kΩ	±5%	SRD1/6P
R729LR	1119127	ME	0.47Ω	±10%	SRD2P
R801	1110609	ME	47Ω	±5%	SRD1/4P
R802	0129611	CF	2.7kΩ	±5%	SRD1/4P
R803	0113615	CF	1kΩ	±5%	SRD1/6P
R804	0113615	CF	1kΩ	±5%	SRD1/6P
R805	0129611	CF	2.7kΩ	±5%	SRD1/6P
R806	1113830	ME	10Ω	±5%	RN1/2B
R807	1113830	ME	10Ω	±5%	RN1/2B
R808	0113365	CF	1kΩ	±5%	RN1/2B
R809	0113627	CF	3.3kΩ	±5%	SRD1/6P
R810	0113639	CF	10kΩ	±5%	SRD1/6P
R901	0113663	CF	100kΩ	±5%	SRD1/6P
R902	0113623	CF	2.2kΩ	±5%	SRD1/6P
R903	0113667	CF	150kΩ	±5%	SRD1/6P
R904	0113631	CF	4.7kΩ	±5%	SRD1/6P
R905	0113641	CF	12kΩ	±5%	SRD1/6P
R906LR	0113629	CF	3.9kΩ	±5%	SRD1/6P
R907LR	0113597	CF	180Ω	±5%	SRD1/6P
R908LR	0113653	CF	39kΩ	±5%	SRD1/6P
R909LR	0113629	CF	3.9kΩ	±5%	SRD1/6P
R910	0113615	CF	1kΩ	±5%	SRD1/6P
△R913	1113834	FR	22Ω	±5%	RN1/2B

ICs & TRANSISTORS

IC401	2368041	NJM4558DX
IC402	2387564	TC9152P
IC403	2387563	TC9151P
IC405	2368041	NJM4558DX
IC601	2368041	NJM4558DX
IC602LR	2300241	M5227P
IC603	2368041	NJM4558DX
IC604	2368041	NJM4558DX
IC605	2368041	NJM4558DX
IC606	2368041	NJM4558DX
IC701LR	2300891	STK4044VH
IC901	2387581	μPC1237H
IC902	2387392	IR2E27A

SYMBOL NO.	PART NO.	DESCRIPTION
Q701	2327893	2SA872(E)
Q702LR	2328872	2SD756 E
Q703LR	2329183	2SA1015 (GR)
Q704LR	2328653	2SC1740LN E
Q801	2328625	2SB647 C
Q802	2317822	2SD880(Y)
Q803	2328653	2SC1740LN E

DIODES

D401	2337601	1S2473
D402	2337601	1S2473
D403	2337601	1S2473
D404	2337601	1S2473
D405	2337601	1S2473
D406	2337601	1S2473
D407	2337601	1S2473
D408	2337601	1S2473
D409	2337601	1S2473
D410	2337601	1S2473
D411	2337601	1S2473
D412	2337601	1S2473
D413	2337601	1S2473
D414	2337601	1S2473
D415	2337601	1S2473
D416	2337601	1S2473
D417	2337601	1S2473
D418	2398401	SLR-54DC5
D419	2398401	SLR-54DC5
D420	2398401	SLR-54DC5
D421	2398401	SLR-54DC5
D422	2398401	SLR-54DC5
D423	2398401	SLR-54DC5
D424	2398401	SLR-54DC5
D425	2398401	SLR-54DC5
D426	2398401	SLR-54DC5
D427	2398401	SLR-54DC5
D428	2398401	SLR-54DC5
D429	2398401	SLR-54DC5
D430	2398401	SLR-54DC5
D431	2337601	1S2473
D432	2398421	SLR34DC3
D433	2398421	SLR34DC3
D434	2398421	SLR34DC3
D435	2398421	SLR34DC3
D701LR	2337601	1S2473
D702LR	2337641	1S581
D703LR	2337601	1S2473
D704LR	2337151	1S2076A
D705	2337151	1S2076A
D801	2338721	S1WB20
D802	2337341	S5VB20
D803	2337762	ERB12-01R
D901LR	2337601	1S2473
D902LR	2337921	1K34A
D903LR	2337601	1S2473
D904LR	2398401	SLR-54DC5
D905LR	2398401	SLR-54DC5
D906LR	2398401	SLR-54DC5
D907LR	2398401	SLR-54DC5

SYMBOL NO.	PART NO.	DESCRIPTION
D908LR	2398401	SLR-54DC5
D909LR	2398401	SLR-54DC5
D910LR	2337601	1S2473
ZD402	2337189	HZ-15-3
ZD801	2337189	HZ-15-3
ZD802	2337189	HZ-15-3
ZD803	2337555	HZ11B2

VARIABLE RESISTORS

R605	0189361	Slide block 50kΩ-(B) (GRAPHIC EQUALIZER)
R636	0158764	10kΩ-(B) (EFFECT)
R640	0151679	200kΩ (BALANCE)
R643	0151857	200kΩ-(B) (MAIN VOLUM)

MISCELLANEOUS

L701LR	2227311	Audio trap coil
S001	2600151	Push switch (POWER)
S401	2639682	Tact switch (PHONO)
S402	2639682	Tact switch (CD)
S403	2639682	Tact switch (TUNER)
S404	2639682	Tact switch (VCR-1)
S405	2639682	Tact switch (VCR-2)
S406	2639682	Tact switch (TAPE)
S601	2600262	Push switch (SURROUND ON/OFF)
S602	2600262	Push switch (SOURCE SELECT)
S603	2600261	Push switch (LOUDNESS)
S701	2600081	Push switch (SURROUND SPEAKER)
S702	2600081	Push switch (MAIN SPEAKER)
△	2618053	Voltage switch [for EW]
△F001	2727896	Fuse 5A 125V [for CS]
△	2727199	Fuse T-2.5A 250V [except CS, EW, US]
△F801	2727191	Fuse T-1A [for VK, KS, VS]
△F802	2727191	Fuse T-1A [for VK, KS, VS]
RY701	2647711	DH Relay
	2688281	Push terminal
	2678345	US Pin jack (8P)
	2677754	Headphone jack

FT-D100

SYMBOL NO.	PART NO.	DESCRIPTION		
CAPACITORS				
C101	0240108	CD	0.022μF ±30%	16V
C102	0240108	CD	0.022μF ±30%	16V
C103	0240108	CD	0.022μF ±30%	16V
			[for BS, VS, ES]	
C104	0240108	CD	0.022μF ±30%	16V
			[for BS, VS, ES]	
C105	0240108	CD	0.022μF ±30%	16V
C106	0240108	CD	0.022μF ±30%	16V
C107	0230022	CD	27PF ±5%	50V
			[for BS, VS, ES]	
C108	0240108	CD	0.022μF ±30%	16V
C109	0240108	CD	0.022μF ±30%	16V
C110	0240108	CD	0.022μF ±30%	16V
C111	0240108	CD	0.022μF ±30%	16V
			[for BS, VS, ES]	
C112	0279326	MF	510PF ±2%	100V
C113	0230064	CC	12PF ±5%	50V
C114	0228321	ST	270PF ±5%	50V
			[for BS, VS, ES]	
C115	1246465	CD	110PF ±5%	50V
			[for BS, VS, ES]	
C116	02528112	EL	1μF ±20%	50V
			[for BS, VS, ES]	
C117	0240108	CD	0.022μF ±30%	16V
			[for BS, VS, ES]	
C118	0240108	CD	0.022μF ±30%	16V
C119	0252802	EL	0.22μF ±20%	50V
			[for ZS]	
C120	0240108	CD	0.022μF ±30%	16V
			[for ZS]	
C121	0252521	EL	10μF ±20%	16V
			[for ZS]	
C122	0240003	CD	180PF ±10%	50V
			[for ZS]	
C123	0230026	CD	39PF ±5%	50V
			[for ZS]	
C124	1244173	CC	0.022μF ^{+80%} / _{-20%}	50V
			[for ZS]	
C125	1244173	CC	0.022μF ^{+80%} / _{-20%}	50V
			[for ZS]	
C201	0240106	CD	0.01μF ±30%	25V
			[except CS, US]	
C202	0240120	CD	0.01μF ±30%	16V
			[except CS, US]	
C204	0240108	CD	0.022μF ±30%	16V
C205	0230016	CD	15PF ±5%	50V
C206	0240108	CD	0.022μF ±30%	16V
C207	02528112	EL	1μF ±20%	50V
C208	0240108	CD	0.022μF ±30%	16V
C209	0252521	EL	10μF ±20%	16V
C210	0240108	CD	0.022μF ±30%	16V
C211	0240108	CD	0.022μF ±30%	16V
C212	02522312	EL	100μF ±20%	6.3V
C213	02525222	EL	22μF ±20%	16V
C214	0240108	CD	0.022μF ±30%	16V
C215	0240108	CD	0.022μF ±30%	16V
C216	0230036	CD	100PF ±5%	50V
C219	0230028	CD	47PF ±5%	50V
C220	0240108	CD	0.022μF ±30%	16V
			[except CS, US]	
C221	0240120	CD	0.01μF ±30%	16V
			[for C ₂ , US]	

SYMBOL NO.	PART NO.	DESCRIPTION		
C301	0252521	EL	10μF ±20%	16V
C302	02525252	EL	47μF ±20%	16V
C303	0240009	CD	560PF ±10%	50V
C304	0240005	CD	270PF ±10%	50V
			[for VS, ZS]	
	0240021	CD	1200PF ±20%	50V
			[for CS, US]	
	0240008	CD	470PF ±10%	50V
			[except US, CS, ZS, VS]	
C305	0240005	CD	270PF ±10%	50V
			[for VS, ZS]	
	0240021	CD	1200PF ±20%	50V
			[for CS, US]	
	0240008	CD	470PF ±10%	50V
			[except US, CS, ZS, VS]	
C306	02528112	EL	1μF ±20%	50V
			[except VS]	
	02528152	EL	4.7μF ±20%	50V
			[for VS]	
C307	02528112	EL	1μF ±20%	50V
			[except VS]	
	02528152	EL	4.7μF ±20%	50V
			[for VS]	
C309	02528112	EL	1μF ±20%	50V
C310	0252521	EL	10μF ±20%	16V
C311	02528052	EL	0.47μF ±20%	50V
C312	02528112	EL	1μF ±20%	50V
C313	0240108	CD	0.022μF ±30%	16V
C314	02525312	EL	100μF ±20%	16V
C316	0252521	EL	10μF ±20%	16V
			[for VS, ZS]	
C318	0240102	CD	2200PF ±30%	25V
			[for ZS]	
	0240020	CD	1000PF ±20%	50V
			[for VS]	
C319	0240102	CD	2200PF ±30%	25V
			[for ZS]	
	0240020	CD	1000PF ±20%	50V
			[for VS]	
C401	0252803	EL	0.33μF ±20%	50V
C501	0240102	CD	2200PF ±30%	25V
C502	0252802	EL	0.22μF ±20%	50V
			[for BS, VS, ZS]	
C504	02528152	EL	4.7μF ±20%	50V
C505	02528112	EL	1μF ±20%	50V
			[for BS, VS, ES]	
C506	02750162	MF	0.068μF ±10%	50V
			[for BS, VS, ZS]	
C507	0252231	EL	100μF ±20%	6.3V
C508	0240108	CD	0.022μF ±30%	16V
C509	0240106	CD	0.01μF ±30%	25V
C510	0240108	CD	0.022μF ±30%	16V
C511	0240108	CD	0.022μF ±30%	16V
C512	1252242	EL	2200μF ±20%	6.3V
C513	0259891	SC	0.022F	
C514	0230071	CD	24PF ±5%	
C515	0230071	CD	24PF ±5%	
C516	1252722	EL	22μF ±20%	35V
C518	02441732	CD	0.022μF ^{+80%} / _{-20%}	50V
C802	1252735	EL	470μF ±20%	35V
C803	02525312	EL	100μF ±20%	16V
C804	02525312	EL	100μF ±20%	16V
C805	02528252	EL	47μF ±20%	50V
C806	02441712	CD	0.01μF ^{+80%} / _{-20%}	50V

SYMBOL NO.	PART NO.	DESCRIPTION		
C807	02528252	EL	47μF ±20%	50V
C808	02528152	EL	4.7μF ±20%	50V
C809	02528112	EL	1μF ±20%	50V
RESISTORS				
R101	0129611	CF	2.7kΩ ±5%	SRD1/4P
			[for ZS, CS, US]	
	0129623	CF	8.2kΩ ±5%	SRD1/4P
			[for except ZS, CS, US]	
R102	0129631	CF	10kΩ ±5%	SRD1/4P
R103	0129631	CF	10kΩ ±5%	SRD1/4P
			[for BS, VS, ES]	
R104	0129631	CF	10kΩ ±5%	SRD1/4P
			[for BS, VS, ES]	
R105	0129631	CF	10kΩ ±5%	SRD1/4P
R106	0129631	CF	10kΩ ±5%	SRD1/4P
			[for BS, VS, ES]	
△R107	1123618	FR	56Ω ±5%	SRD1/4P
			[for ZS]	
△	0123625	FR	220Ω ±5%	SRD1/4P
R108	0129669	CF	220kΩ ±5%	SRD1/4P
R109	0129669	CF	220kΩ ±5%	SRD1/4P
			[for BS, VS, ES]	
R110	0129661	CF	100kΩ ±5%	SRD1/4P
			[for BS, VS, ES]	
R111	0129609	CF	2.2kΩ ±5%	SRD1/4P
			[for BS, VS, ES]	
R112	0129579	CF	560Ω ±5%	SRD1/4P
R113	0129617	CF	4.7kΩ ±5%	SRD1/4P
			[for BS, VS, ES]	
R114	0129649	CF	56kΩ ±5%	SRD1/4P
R115	0129561	CF	100Ω ±5%	SRD1/4P
			[for ZS]	
R116	0129631	CF	10kΩ ±5%	SRD1/4P
			[for ZS]	
R117	0129661	CF	100kΩ ±5%	SRD1/4P
R118	0129603	CF	1.2kΩ ±5%	SRD1/4P
			[for ZS]	
R119	0129661	CF	100kΩ ±5%	SRD1/4P
			[for ZS]	
R120	01133652	CF	1kΩ ±5%	SRD1/2P
R121	0129567	CF	180Ω ±5%	SRD1/4P
			[except VS, ZS, CS, US]	
R122	0129561	CF	100Ω ±5%	SRD1/4P
			[except VS, ZS, CS, US]	
	0129603	CF	1.2kΩ ±5%	SRD1/4P
			[for VS, ZS]	
R124	0129551	CF	68Ω ±5%	SRD1/4P
			[except ZS, US, CS]	
R201	0129573	CF	330Ω ±5%	SRD1/4P
			[except CS, US]	
R202	0129605	CF	1.5kΩ ±5%	SRD1/4P
			[except CS, US]	
R205	0129601	CF	1kΩ ±5%	SRD1/4P
R206	0129605	CF	1.5kΩ ±5%	SRD1/4P
			[for CS, US]	
	0129607	CF	1.8kΩ ±5%	SRD1/4P
			[except CS, US]	
R207	0129577	CF	470Ω ±5%	SRD1/4P
R208	0129577	CF	470Ω ±5%	SRD1/4P
R209	0129601	CF	1kΩ ±5%	SRD1/4P
R210	0129601	CF	1kΩ ±5%	SRD1/4P
R211	0129573	CF	330Ω ±5%	SRD1/4P
R213	0129651	CF	68kΩ ±5%	SRD1/4P
			[for SA, US, CS]	

SYMBOL NO.	PART NO.	DESCRIPTION
R214	0129579	CF 560Ω ±5% SRD1/4P [for CS, US]
R216	0129617	CF 4.7kΩ ±5% SRD1/4P [for CS, US]
R217	0129575	CF 390Ω ±5% SRD1/4P [for CS, US]
R218	0129579	CF 560Ω ±5% SRD1/4P [for CS, US]
R219	0129561	CF 100Ω ±5% SRD1/4P [for CS, US]
R302	1123619	FR 68Ω ±5% SRD1/4P
R303	0129665	CF 150kΩ ±5% SRD1/4P [for VS]
	0129661	CF 100kΩ ±5% SRD1/4P [except VS, ZS, CS, US]
	0129649	CF 56kΩ ±5% SRD1/4P [for CS, US]
R304	0129665	CF 150kΩ ±5% SRD1/4P [for VS]
	0129661	CF 100kΩ ±5% SRD1/4P [except VS, ZS, CS, US]
	0129649	CF 56kΩ ±5% SRD1/4P [for CS, US]
	0129663	CF 120kΩ ±5% SRD1/4P [for ZS]
R303	0129663	CF 120kΩ ±5% SRD1/4P [for ZS]
R305	0129609	CF 2.2kΩ ±5% SRD1/4P [for VS]
	0129613	CF 3.3kΩ ±5% SRD1/4P [except VS]
R306	0129609	CF 2.2kΩ ±5% SRD1/4P [for VS]
	0129613	CF 3.3kΩ ±5% SRD1/4P [except VS]
R307	0129617	CF 4.7kΩ ±5% SRD1/4P [for VS]
	0129661	CF 100kΩ ±5% SRD1/4P [except VS]
R308	0129617	CF 4.7kΩ ±5% SRD1/4P [for VS]
	0129661	CF 100kΩ ±5% SRD1/4P [except VS]
R309	0129647	CF 47kΩ ±5% SRD1/4P [except ZS, CS, US]
	0129645	CF 39kΩ ±5% SRD1/4P [for ZS]
	0129651	CF 68kΩ ±5% SRD1/4P [for US, CS]
R310	0129613	CF 3.3kΩ ±5% SRD1/4P
R311	0129661	CF 100kΩ ±5% SRD1/4P
R312	0129609	CF 2.2kΩ ±5% SRD1/4P
R314	0129619	CF 5.6kΩ ±5% SRD1/4P
R315	0129619	CF 5.6kΩ ±5% SRD1/4P
R320	0129665	CF 150kΩ ±5% SRD1/4P [for VS]
R321	0129665	CF 150kΩ ±5% SRD1/4P [for VS]
R401	0129631	CF 10kΩ ±5% SRD1/4P
R402	0129647	CF 47kΩ ±5% SRD1/4P
R408	0129631	CF 10kΩ ±5% SRD1/4P [except ZS, CS, US]
	0129645	CF 39kΩ ±5% SRD1/4P [for ZS, CS, US]
R409	0129561	CF 100Ω ±5% SRD1/4P [except ZS]

SYMBOL NO.	PART NO.	DESCRIPTION
	0129567	CF 180Ω ±5% SRD1/4P [for ZS]
R410	0129647	CF 47kΩ ±5% SRD1/4P
R411	0129639	CF 22kΩ ±5% SRD1/4P
R412	0129631	CF 10kΩ ±5% SRD1/4P
R501	0129609	CF 2.2kΩ ±5% SRD1/4P
R502	0129621	CF 6.8kΩ ±5% SRD1/4P
R503	0129581	CF 680Ω ±5% SRD1/4P
R505	0129605	CF 1.5kΩ ±5% SRD1/4P
R506	0129621	CF 6.8kΩ ±5% SRD1/4P [for BS, VS, ES]
R507	0129621	CF 6.8kΩ ±5% SRD1/4P [for BS, VS, ES]
R508	0129631	CF 10kΩ ±5% SRD1/4P [for BS, VS, ES]
R509	0129601	CF 1kΩ ±5% SRD1/4P [for BS, VS, ES]
R510	0129551	CF 68Ω ±5% SRD1/4P
R511	0129661	CF 100kΩ ±5% SRD1/4P
R512	0129661	CF 100kΩ ±5% SRD1/4P
R513	0129661	CF 100kΩ ±5% SRD1/4P
R514	0129661	CF 100kΩ ±5% SRD1/4P [except CS, US]
	0129661	CF 100kΩ ±5% SRD1/4P [for CS, US]
R515	0129661	CF 100kΩ ±5% SRD1/4P [except CS, US]
	0129661	CF 100kΩ ±5% SRD1/4P [for CS, US]
R516	0129661	CF 100kΩ ±5% SRD1/4P [for BS, VS, ES]
R517	0129631	CF 10kΩ ±5% SRD1/4P [for BS, VS, ES]
R518	0129601	CF 1kΩ ±5% SRD1/4P
R519	0129619	CF 5.6kΩ ±5% SRD1/4P
R520	0129609	CF 2.2kΩ ±5% SRD1/4P
R521	0129681	CF 680kΩ ±5% SRD1/4P
R522	0129609	CF 2.2kΩ ±5% SRD1/4P
R523	0129601	CF 1kΩ ±5% SRD1/4P
R524	0129619	CF 5.6kΩ ±5% SRD1/4P
R525	0129565	CF 150Ω ±5% SRD1/4P
R526	0129619	CF 5.6kΩ ±5% SRD1/4P
R527	0129601	CF 1kΩ ±5% SRD1/4P
R528	0129645	CF 39kΩ ±5% SRD1/4P
R529	0129647	CF 47kΩ ±5% SRD1/4P
R530	0129647	CF 47kΩ ±5% SRD1/4P
R531	0129631	CF 10kΩ ±5% SRD1/4P
R532	0129647	CF 47kΩ ±5% SRD1/4P
R533	0129647	CF 47kΩ ±5% SRD1/4P
R534	0129661	CF 100kΩ ±5% SRD1/4P [except EW, CS, US]
R535	0129607	CF 1.8kΩ ±5% SRD1/4P
R536	0129661	CF 100kΩ ±5% SRD1/4P [for CS, US]
R801	1123607	FR 6.8Ω ±5% SRD1/4P
R802	0129609	CF 2.2kΩ ±5% SRD1/4P
R803	0129601	CF 1kΩ ±5% SRD1/4P
R804	0129615	CF 3.9kΩ ±5% SRD1/4P
R805	0129615	CF 3.9kΩ ±5% SRD1/4P
R806	0129569	CF 220Ω ±5% SRD1/4P
R807	0129615	CF 3.9kΩ ±5% SRD1/4P
R808	01390052	RC 2.7MΩ ±10% SRD1/2P [for CS, US]

SYMBOL NO.	PART NO.	DESCRIPTION
ICs & TRANSISTORS		
IC201	23684312	AN278 [except CS, US]
IC202	2387321	AN7273
IC301	2388941	LA3410A
IC501	23687412	μPB553AC
IC502	2389461	μPD1704C-554
IC503	2387421	AN6873N
IC504	2387611	BA6251
Q101	2328652	2SC1740LN(S) [for BS, VS, ES]
Q102	2328652	2SC1740LN(S) [for BS, VS, ES]
Q103	2328652	2SC1740LN(S) [for ZS]
Q104	2328802	2SK104F [for ZS]
Q201	05734862	2SC460(B) [for CS, US]
Q301	2328652	2SC1740LN(S)
Q302	2328652	2SC1740LN(S)
Q303	2329183	2SA1015(GR)
Q401	2329183	2SA1015(GR)
Q402	2329183	2SA1015(GR)
Q405	2328652	2SC1740LN(S)
Q406	2328652	2SC1740LN(S)
Q501	2328652	2SC1740LN(S)
Q502	2328652	2SC1740LN(S)
Q503	2328652	2SC1740LN(S) [for BS, VS, ES]
Q504	2328652	2SC1740LN(S) [for BS, VS, ES]
Q505	2328652	2SC1740LN(S)
Q506	2329183	2SA1015(GR) [for BS, VS, ES]
Q507	2329183	2SA1015(GR) [for BS, VS, ES]
Q801	2317802	2SD1266(E)
Q802	2328652	2SC1740LN(S)
Q803	2329183	2SA1015(GR)
DIODES		
D101	2337601	1S2473
D102	2337601	1S2473
D103	2339921	KV1236Z(2) [except BS, VS, ES]
	2339921	KV1236Z(2) [for BS, VS, ES]
D104	2339921	KV1236Z(2) [for BS, VS, ES]
D105	2337601	1S2473 [for BS, VS, ES]
D106	2337601	1S2473 [for BS, VS, ES]
D107	2337601	1S2473 [for BS, VS, ES]
D108	2337931	1K60R [for ZS]
D109	2337931	1K60R [for ZS]
D110	2337601	1S2473
D111	2337601	1S2473
D301	2337601	1S2473
D302	2337601	1S2473
D303	2337601	1S2473
D304	2337601	1S2473
D501	2337601	1S2473
D502	2337601	1S2473
D503	2337601	1S2473
D504	2337601	1S2473
D505	2337601	1S2473
D506	2337601	1S2473
D801	2337762	ERB12-01
D802	2337762	ERB12-01
D803	2337762	ERB12-01
D804	2337762	ERB12-01
D805	2337762	ERB12-01
D806	2337762	ERB12-01

SYMBOL NO.	PART NO.	DESCRIPTION
ZD501	2337541	HZ-7A-1
ZD502	2337122	HZ-6B
ZD801	2337514	HZ-6(B)
ZD802	23371882	HZ-24-2
D507	2339104	SLP-660C
COILS		
L101	2136503	MW antenna coil
L102	2136504	LW antenna coil
T101	2136493	MW osc coil
T102	2136494	LW osc coil
T201	2155173	FM discriminator transformer
T203	2154493	AM IF transformer
MESCELLANEOUS		
CT101	0283127	Capacitor, trimmer 20PF
CT102	0283127	Capacitor, trimmer 20PF [BS, VS, ES only]
CP101	2136941	Filter, band pass [for ZS]
CP301	2136312	Anti birdie filter [for VS, ZS]
CP302	2136311	Leak filter [for VS]
CP303	2136311	Leak filter [for VS]
CP501	0241892	CD 330PF ±20% 50V
CP502	0189014	Resistor, composition 100kΩ 0.063W ±10%
CP503	0189031	Resistor, composition 39kΩ 0.063W ±10%
MF201	2134982	Ceramic filter [for CS, US]
	2135002	Ceramic filter [for ZS]
	2135002	Ceramic filter [except ZS, CS, US]
MF202	2134982	Ceramic filter [for CS, US]
	2135002	Ceramic filter [for ZS]
	2135002	Ceramic filter [except ZS, CS, US]
MF203	2135002	Ceramic filter [for ZS]
	2135002	Ceramic filter [for VS]
MF204	2155152	AM ceramic filter
	2425581	FM tuner pack [except ZS]
	2425591	FM tuner pack [for ZS]
	2689375	Antenna terminal [for CS, US]
	2689374	Antenna terminal [except CS, US]
X301	2136661	Ceramic filter
X501	2789281	Crystal oscillator (4.5MHZ)
S501	2639972	Switch (FM)
S502	2639972	Switch (MW) [for BS, VS, ES]
S503	2639972	Switch (LW) [for BS, VS, ES] (AM) [except BS, VS, ES]
S504	2639971	Switch (MENO)
S505	2638241	Switch (AUTO/MONO)
S506	2639971	Switch (+10)
S507	2639971	Switch (P1/P11)
S508	2639971	Switch (P2/P12)
S509	2639971	Switch (P3/P13)
S510	2639971	Switch (P4/P14)
S511	2639971	Switch (P5/P15)
S512	2639971	Switch (P6/P16)
S513	2639971	Switch (P7/P17)

SYMBOL NO.	PART NO.	DESCRIPTION
S514	2639971	Switch (P8/P18)
S515	2639971	Switch (P9/P19)
S516	2639971	Switch (P10/P20)
S517	2639682	Switch (DOWN)
S518	2639682	Switch (UP)
S519	2627531	Slide switch (MW SPACING SELECTOR) [for EW]
S801	2639454	1 key push switch (SE) (POWER/STAND-BY)
△S802	2618741	Switch (POWER SUPPLY SELECT) [for EW]
FL501	2789301	Flourescent display tube
△F801	2727691	Fuse T200mA [except VS, KS, CS, US]
△F802	2727691	Fuse T200mA [VS, KS only]

**HA-D100
CABINET**

**FT-D100
CABINET**

SYMBOL NO.	PART NO.	DESCRIPTION
	4040532	Front panel ass'y
	3947541	Nylon rivet
	4462237	Cover (Top)
	3307023	Knob (35) ass'y
	3301181	Slide knob ass'y
	3301141	Push button (Loudness)
	3299653	14 knob (Balance)
	3958755	Push button
	3305092	Power button
	3368293	Wire (P)
	3298952	10 knob
	3296481	Push button
	3801131	Insulate sheet
	3916411	Leg
	3927411	Foot (10 x 21.8)
	4567432	3φ x 8 bind tapping head screw (BC)
	4784106	3φ x 10 bind tapping head screw
	8691410	3φ x 10 BT bind screw
	4567454	3φ x 12 bind tapping head screw
	4567455	3φ x 14 DT bind head screw
	4567422	4φ x 8 bind head screw
	4567443	4φ x 10 bind head screw
	4567432	3φ x 8 bind tapping head screw (BC) [for US]
	8691410	3φ x 10 BT bind head screw
	4567413	3φ x 10 bind head screw
	4567412	3φ x 8 DT bind head screw
△PT001	2248931	Power transformer [for CS, US]
△PT001	2248932	Power transformer [for ES, KS, VS, ZS]
△PT001	2248933	Power transformer [for BS, SA]
△PT001	2248934	Power transformer [for EW]
	4468241	Rear plate [for US, CS]
	4468242	Rear plate [for SA, KS, ES, VS]
	4468243	Rear plate [for EW]
	4575661	Earth screw
	4408861	Washer
△	0043793	Bushing (3P-4) [for EW]
△	3913006	Bushing (4N-4) [except EW]
△	2700122	Power supply cord [for CS, US]
△	2748752	Power supply cord [for ES, KS, VS, ZS]
△	2749582	Power supply cord [for BS]
△	2749622	Power supply cord [for SA]
△	2718113	Power supply cord [for EW]
△	2658414	AC outlet [for CS, EW, US]
△	2727671	Fuse holder [for EW]
△	2727973	Fuse holder [except CS, EW, US]
	4567411	3φ x 6 DT bind head screw
	4573552	3φ x 16 bind tapping head screw
	4784106	3φ x 10 bind tapping head screw
	8699412	3φ x 12 bind tapping head screw
	4567411	3φ x 6 DT bind head screw

SYMBOL NO.	PART NO.	DESCRIPTION
	3203434	Front panel ass'y [for CS, US]
	3203435	Front panel ass'y [for BS, VS, ES]
	3203436	Front panel ass'y [for EW, ZS, KS, SA]
	3307002	T button ass'y
	3301754	Button (Function)
	3297525	Button (Power)
	4450360	Cover (Top)
	2710562	Earth cord
	3927411	Foot
	4567432	3φ x 8 DT bind tapping head screw (BC)
	4567413	3φ x 10 bind head screw
	4567443	4φ x 10 bind head screw
	4567454	3φ x 12 DT bind tapping head screw
	86914102	3φ x 10 bind tapping head screw
	4784106	3φ x 10 bind tapping head screw
	4468578	Rear plate
	4468571	Rear plate [US, CS]
	4468573	Rear plate [except EW, CS, US]
	4468572	Rear plate [for EW]
△	00437932	Bushing (3P-4) [for EW, CS, US]
△	3913006	Bushing (4N-4) [except EW, CS, US]
△	2700121	Power supply cord [for CS, US]
△	2749622	Power supply cord [for SA]
△	2748754	Power supply cord [for VS, ES, SA, CS, US]
△	2718113	Power supply cord [for EW]
△	2749582	Power supply cord [for BS]
	2703111	Patch cord
	2757525	FM antenna (EX) [except ZS]
	2667922	Siemens plug [for ES]
	4021801	AM loop antenna
△	2248303	Power transformer (240V) [for BS, SA]
△	2248304	Power transformer (W) [except BS, SA, CS, US]
	4567451	3φ x 6 BT bind screw (SI)
	3968451	LED holder (M)
	2710825	Patch cord
	3297500	Button, (Tact) (4 x 16)

RTV servis Horvat

Kešinci, 31402 Semeljci

031-856-139

031-856-637

098-788-319

rtv-servis-horvat@os.tel.hr

Croatia



HITACHI SALES EUROPA GmbH

Postfach 801060 Rungedamm 2, 2050 Hamburg 80,
West Germany
Tel. 040-734 11-0

HITACHI SALES (U.K.) Ltd.

Hitachi House, Station Road, Hayes, Middlesex UB3
4DR, England
Tel. 01-848-8787

HITACHI SALES SCANDINAVIA AB

Rissneleden 8, Box 7138, 172-07 Sundbyberg, Sweden
Tel. 08-98 52 80

HITACHI SALES NORWAY A/S

Oerebekk 1620, Gressvik, P.O. Box 46, N-1601,
Fredrikstad, Norway
Tel. 032-28255

SUOMEN HITACHI OY

Takojankatsu 5, 15800 Lahti 80, Finland
Tel. Lahti 44 241

HITACHI SALES A/S

Kuldysen 13, DK-2630, Taastrup, Denmark
Tel. 02-999200

HITACHI SALES A.G.

Bahnhofstrasse, 19, 5600 Lenzburg, Switzerland
Tel. 064-513621

HITACHI SALES WARENHANDELS GMBH

A-1180/Wien, Kreuzgasse 27, Austria
Tel. 0222-439367

HITACHI SALES ITALIANA, S.P.A.

Via Cristoforo Colombo 49, Trezzano sul naviglio
(Milano), Italy
Tel. 02-44 59 031

HITACHI SALES BELGIUM S.A.

56 Chaussee de Namur B-1400 Nivelles, Belgium
Tel. (003267) 227181

HITACHI SALES IBERICA, S.A.

Gran Via Carlos Tercero, 101, 1-1, Barcelona-28,
Spain
Tel. 330-8652

HITACHI MAROC (RADIO TV ELECTRO-MANAGER), S.A.

Rue du Havre, Casablanca, Morocco
Tel. 30-73-68, 30-73-57

HITACHI CANARIAS S.A.

Calle San-Francisco No. 19, Santa Cruz de Tenerife
Canary Islands
Tel. 24-64-98

HITACHI SALES (HELLAS) LTD.

110 Syngrou St., Athens, Greece
Tel. 9219082, 9233469

HITACHI SALES (MALAYSIA) SDN. BHD.

17, Jalan 20/16, Petaling Jaya, Selangor, Malaysia
Tel. 762523, 769918, 769836, 762594

HITACHI (SINGAPORE) PTE., LTD.

Room B, C & D, 15th Floor, Yen San Building
268 Orchard Road, Singapore 9, Singapore
Tel. 7378244, 7379826

HITACHI SALES (THAILAND) LTD.

2242-48, New Petchburi Road, Bangkok, Hueykuang
Bangkok, Thailand
Tel. 314-2741

HITACHI ELECTRIC SERVICE CO., (HONG KONG) LTD.

4th Floor Leun Tai Industrial Bldg., 72-76 Kwai Cheong
Road Kwai Chung N.T., Hong Kong
Tel. 240126

HITACHI SALES AUSTRALIA PTY LTD.

153 Keys Road, Moorabbin, Victoria 3189 Australia
Tel. 555-8722

HITACHI SALES CORPORATION OF AMERICA

Eastern Regional Office
1290 Wall Street West, Lyndhurst, New Jersey 07071, U.S.A.
Tel. 201-935-8980

Mid-Western Regional Office

1400 Morse Ave., Elk Grove Village, Ill. 60007, U.S.A.
Tel. 312-593-1550

Southern Regional Office

510 Plaza Drive, College Park, Georgia 30349, U.S.A.
Tel. 404-763-0360

Western Regional Office

401 West Artesia Boulevard, Compton, California 90220 U.S.A.
Tel. 213-537-8383

HITACHI SALES CORPORATION OF HAWAII, INC.

3219 Koapaka Street, Honolulu, Hawaii 96819, U.S.A.
Tel. 808-836-3621

HITACHI (HSC) CANADA INC.

3300 Trans-Canada Highway, Pointe Claire, Quebec,
H9R 1B1, Canada
Tel. 514-697-9150

Hitachi Sales Centroamericans, S.A.

San Rafael de Excazu, (Apartado 10272), San Jose,
Costa Rica
Tel. 28-20-11, 28-00-37

Hitachi Sales Corporation de Panama, S.A.

Nuevo Repato E1 Camen, Calle Ramon Arias y Calle B
Edificio Brasil 100, (Apartado 7657) Panama 5
Panama City, Rep of Panama
Tel. 61-3100, 61-4305

Hitachi Sales de Chile Cia., Ltda.

Av. Mexico, 0183, Casilla 9793, Correo Central
Santiago, Chile
Tel. 774165

HITACHI-FRANCE S.A.

95-101 Rue Charles Michels,
93200 SAINT-DENIS,
France
Tel. 821 6015

HITACHI LTD. TOKYO JAPAN

Head Office: THE HITACHI ATAGO BLDG.
No. 15-12, 2-Chome Nishi-Shinbashi
Minato-Ku, Tokyo 105, Japan
Tel. Tokyo (03) 502-2111

HA-D100/FT-D100 TY No.508 EGF