

TB6560HQT4-v3

4 AXIS DRIVER USER MANUAL

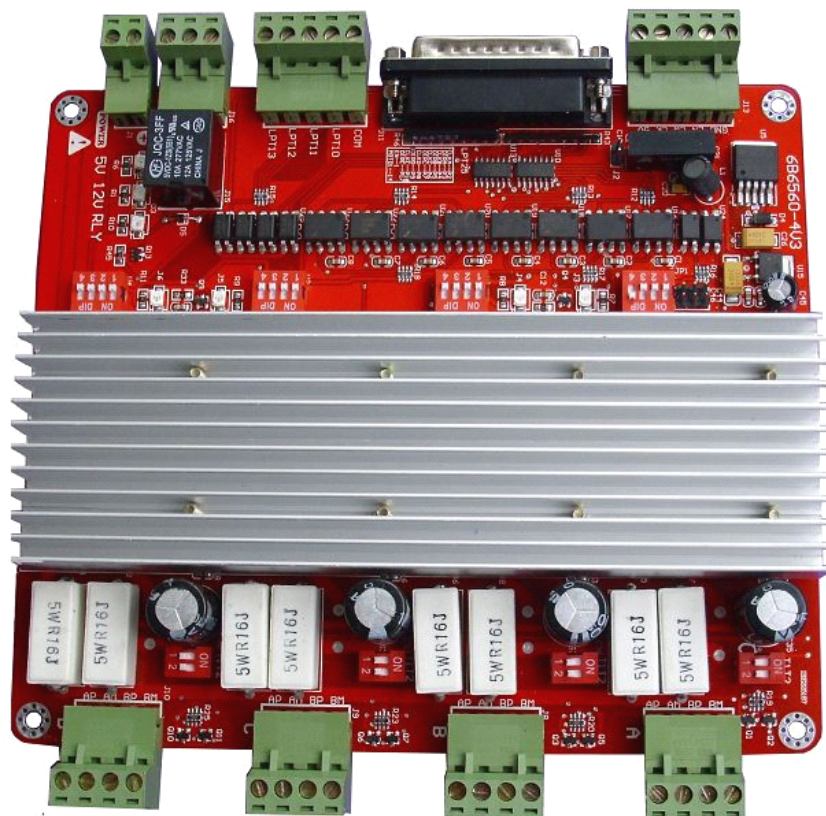

Catalogue

.....	1
1. Overview.....	2
2. TB6560AHQ advantag.....	3
2.1、 At low speed operation System Advantages.....	3
2.2、 In high-speed operation System Advantages.....	3
3. TB6560T4V1 Driver Board Introduction.....	4
4. TB6560T4V1connection drawing.....	5
5. The definition of interface pins.....	5
6. The setting of current,microstepping,decay mode.....	7
6.1、 current setting.....	7

6.2、 microstepping setting.....	8
7. The connection of kinds of stepper motors.....	9
8. The connection of limit switch.....	11
9. The connection of 4 th expand axis.....	12
10. The match between driver board and stepper motors.....	12
11. MACH3software user introduction.....	14
11.1、 Mach3 software open.....	14
11.2、 mach3software basic setting.....	16
11.3、 The limit switch setting in MACH3.....	19
11.4、 Run of the G-code.....	20

1. Overview

The PC Engraving is a Multifunction Engraving Machine collects engrave and Milling.The machine mainly applicable to Processing of a variety of mold like : Embossing plate,Shoe mold, Button mold, zipper-mode, Text die and stamping die design, equipment molds, glass molds and so on.The machine also applies to the advertising industry like: Division licenses, signs, architectural models, badges, badges, nameplates, panels, logo, numbers, signs, craft decoration, furniture decoration and so on. Besides, applies to portrait, landscape, calligraphy lettering, seals and other graphic art sculpture, YIN, YANG Wen-profile, relief production.

Our shop products 4-axis engraving machine drive,using high-performance dedicated micro-step away from the computer control chip TB6560, Open microcomputer control according to user requirements to functional design to the driver board, the composition of the minimum control system. he control panel is suitable for any small and medium-driven two-phase or four-phase hybrid stepper motor. And have current 0.6A, 1.2A, 1.8A, 2.5A 4 stalls adjustable function, support MACH2, MACH3 Series software, support KCAM4 Series software, extensive application and mold machining, engraving and other graphic applications. As a result of new bipolar constant-current chopping technique, high precision, the motor is running, little vibration, low noise, smooth operation, safe and convenient, the vast number of DIY enthusiasts and engraving machine manufacturers product of choice.

2. TB6560AHQ advantage

2.1 At low speed operation System Advantages

Low-speed operating system, is the clock frequency is not high, with small current drive-based systems, such as the speed of a few per minute to 100 turn, the user under the conditions in such applications, such as the use of traditional driving scheme, or a result of integrated chips segmentation is too low, leaving low-speed vibration is too large; or had to choose a high drive segments, so that the cost of an unnecessary increase.

TB6560AHQ driver chip's advantages:

(1). Motor vibration, low noise: Because the chip comes with an optional sub-2,4,16, enough to meet nearly every minute to switch from a few of the applications.

(2). embedded drive less heat: chip built-in cooling large enough alone to support small current-driven thermal requirements.

(3).support a variety of stepper motor selection: customers can choose a hybrid or a slightly larger torque permanent magnet stepper motor, the motor work in the allowed maximum torque of between 30-50%, the electrical costs of almost unchanged; chip provides multi-range current set-up and current-decay mode, supporting the same power index a variety of different parameters under the stepper motor.

2.2 In high-speed operation System Advantages

High-speed operating system refers to a higher clock frequency, and a large current drive-based systems, such as the speed of close to 1000 per minute to switch, under the conditions of such application-driven programs such as the use of traditional or integrated chip segment is too low due to , leaving the system speed range is too small; or because of the excessive breakdown of the high increase in cost, may also occur due to decline in high-frequency torque caused by vibration and noise.

TB6560AHQ driver chip's advantages:

(1). motor vibration, low noise: As the chip comes with 16 sub-TB6560AHQ chip functionality, to meet nearly every minute to switch from a few to the application requirements, and automatically generates a pure sine wave control current, and other high-integrated chip compared to the same high-speed torque is not only not fall under the contrary, increase; TB6560AHQ chip can withstand the peak due to the driving voltage of 40V, 3.5A peak current for the motor torque in the large, high-speed continuous operation under the offer of the technical support.

(2). supports a variety of stepper motor selection: customers can choose a hybrid moment slightly larger or permanent magnet stepper motor, so that the motor operates at maximum torque of between 30-50%, the electrical costs of almost unchanged; chip provides high-current set-up and multi-range current-decay mode, supporting the same power index a variety of different parameters under the stepper motor.

(3). an embedded easy to drive, small size cooling: large current drive, the chip surface to facilitate cooling radiator outside the company can also be directly connected to the user's original controller, metal shell, the embedded drives small size, easy to heat.

In short, due to a high degree of TB6560AHQ chip, the external circuit is extremely simple, highly reliable, support NEMA23 and some NEMA34 stepper motor tens to nearly turn the wide speed range applications, will enable CNC equipment R & D costs and production costs both declined.

3. TB6560T3V1 Driver Board Introduction

The company introduced TB6560T3V1 is the company's accumulated years of design experience drives that the design made of 3-axis engraving machine drive. Main features except the 6560 itself, the other features are as follows:

- 1. it can drive four axis,The 5th axis expansion, to facilitate your needs 5-axis machining when working**
- 2. With optical isolation and DCDC power supply isolation, the full protection of your computer parallel port and equipment;**
- 3. Spindle relay output, easy to use software such as mach3 to control spindle start and stop**
- 4. Semi-flow control functions, and effective to stop the motor when the current is reduced to a minimum**
- 5. Interface with a fan, you can add fan under your choice.**
- 6. With 4 way 0.8-3.5A (peak) rated output of two-phase adjustable-current bipolar stepper motor drive**
- 7. Standard parallel port interface, support for MACH2, KCAM4 series software;**
- 8. with limit switch,can connection 4 aixs limit switch**
- 9. Support four microstepping ——1、 1/2、 1/8、 1/16;**

- 10. 12 — 36V single switching power supply,microchips to use as a 5V power supply, stable and heat small

4. TB6560T4V1 Appearance

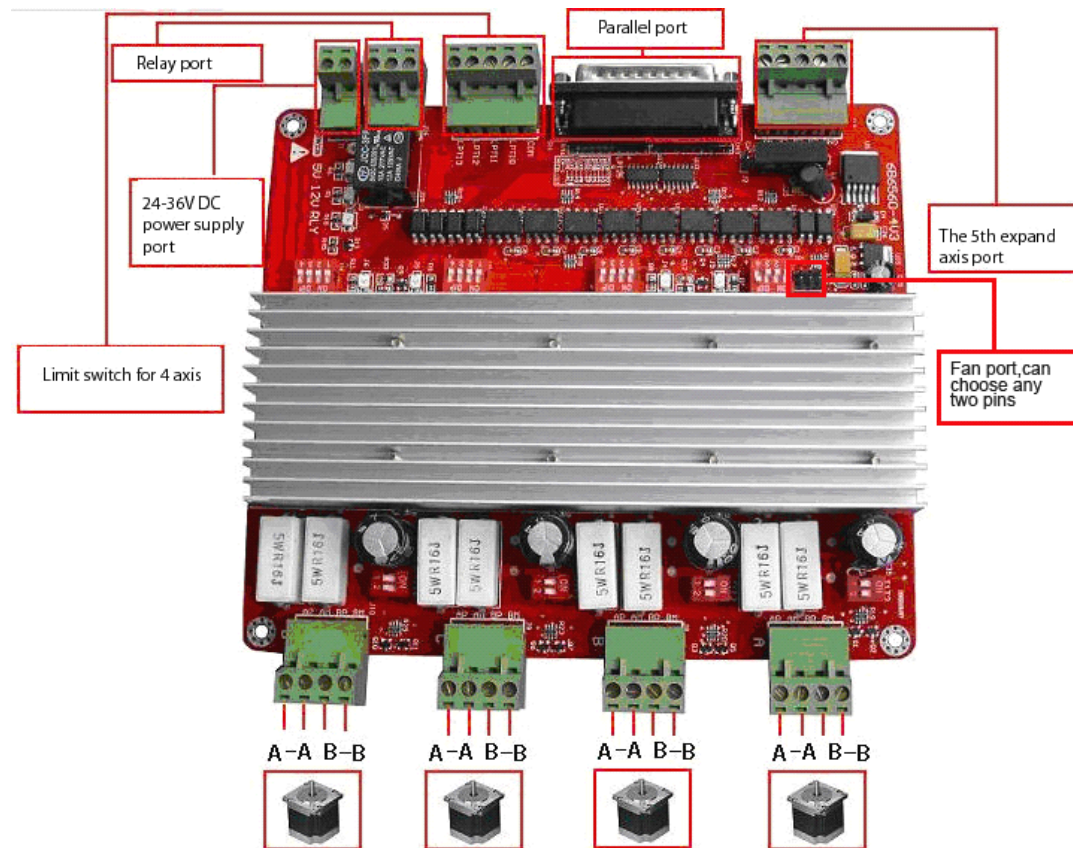

5. Interface and its definition:

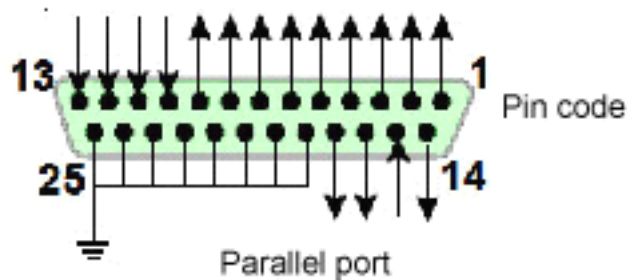

25-pin parallel port control is defined as follows:

DB25 control pin (PIN)	The pin of the drive board	Comment
1	EN	All axes enable
2	STEPX	X(First axis) pulse signal
3	DIRX	X(First axis) direction of the signal
4	STEPY	Y(Second axis)pulse signal
5	DIRY	Y(Second axis)direction of the signal
6	STEPZ	Z(Third axis) pulse signal
7	DIRZ	Z (Third axis) direction of the signal
8	STEPA	A(Fourth axis) pulse signal
9	DIRA	A (Fourth axis) direction of the signal
10	LIMIT-1	Limit input interface 1
11	LIMIT-2	Limit input interface 2
12	LIMIT-3	Limit input interface 3
13	LIMIT-4	Limit input interface 4
14	Relay	
15	Blank	
16	STEPB-	B(Fifth axis) pulse signal
17	DIRB-	B(Fifth axis)direction of the signal
18-25	GND	

6. The setting of current,microstepping and current-decay mode adjustable

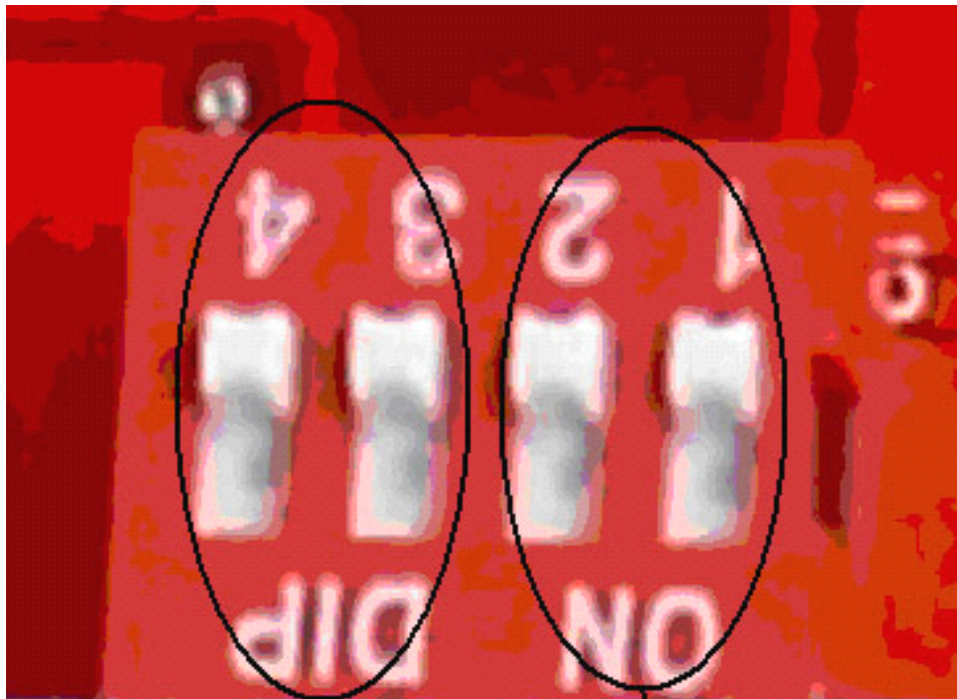

Microstepping setting M1/M2 Decay mode setting D1/D2

6.1、 Current-decay mode setting:

Board marked D1D2 (match with DIP switch 1 and 2) to set the value of switching current-decay

D1/D2: ON/ON——100%; ON/OF——25%;
OF/ON——50%; OF/OF——0%;

D1	D2	Working mode

ON	ON	Fast decay
OF	ON	50% of fast decay
ON	OF	25%of fast decay
OFF	OFF	Slow decay

Q: The stepper motor driver board the specific role of current-decay What is this?

A: The stepper motor is basically a breakdown of the way current subdivision law, according to the phase current sine wave to be tangent to the current point as subdivision points. In the phase current to reach sub-point control is necessary to control the current decay, otherwise it would be if there will be no way to accurately point overshoot stay in the breakdown of perspective. The motor at different speeds in different choices of decay mode. Fast decay at high speed, low speed when the slow decay. Slow decay at high speed there will be vibrations, high noise problem. Low selection of quick decay can lead to motor weakness and in severe cases closed position. Motor Control IC, the current decay is the target of H-bridge switch the control mode. Slow decay, when the high side pipes closed, fast decay time high or low side tubes are closed. Mixed decay is a first, a rapid decay and then a slow decay, mixing ratio of decay time is also a result of chip and power are not the same as

6.2、 microstepping setting

Board marked M1M2(match with DIP swtich 3 and 4) to set the value of switching microstepping resolution

M1	M2	Working mode
OFF	ON	1/16
ON	ON	1/8
ON	OFF	1/2
OFF	OFF	1

Remark:For motor run smoothly, please try to select high segments, such as 1 / 16 microstepping

6.3、 current setting:



Current setting T1/T2

Board marked T1T2(match with DIP swtich 1 and 2) to set the value of switching current setting

T1	T2	Current
OFF	ON	25%*2.5A
ON	ON	50%*2.5A
ON	OFF	75%*2.5A
OFF	OFF	100%*2.5A

Proposed current as close as possible stepper motor rated current

7. The connection of kinds of stepper motors

4 lead wires stepper motor:

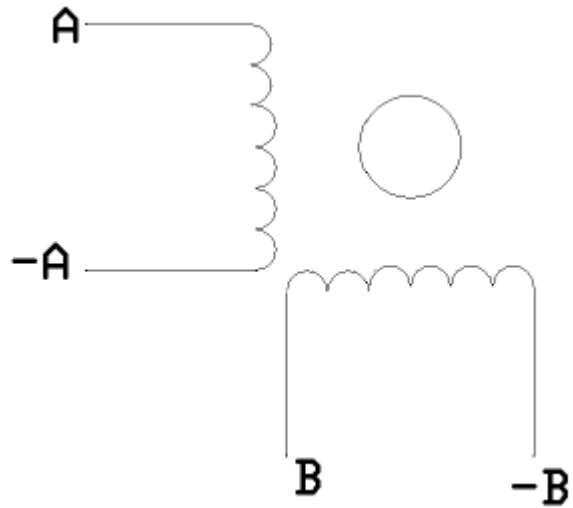

6 lead wires stepper motor:

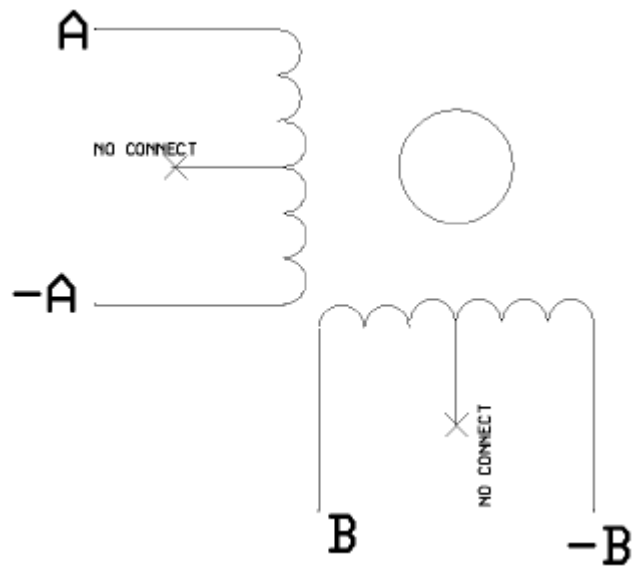

8 lead wires stepper motor:

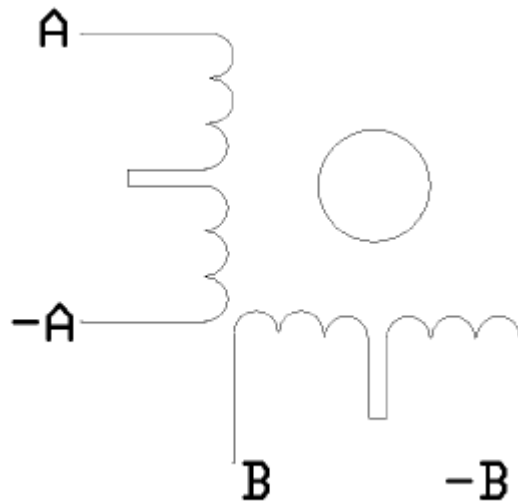

Stepper motor +A -A +B -B connection AP AM BP BM of board port

8. The limit switch port connection:

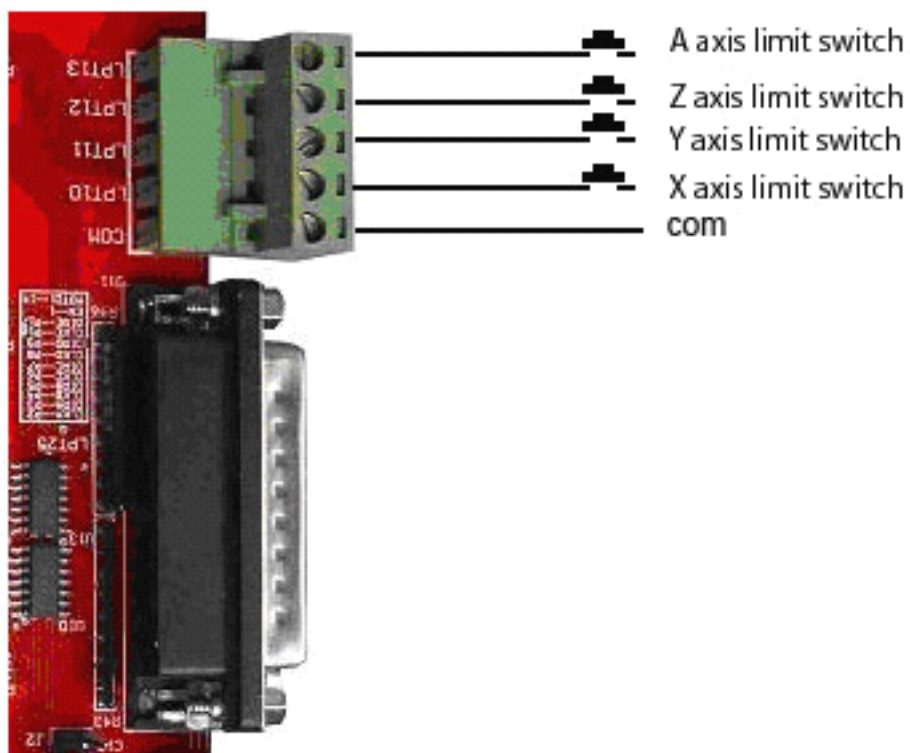

9. The 5th axis expansion port connection:

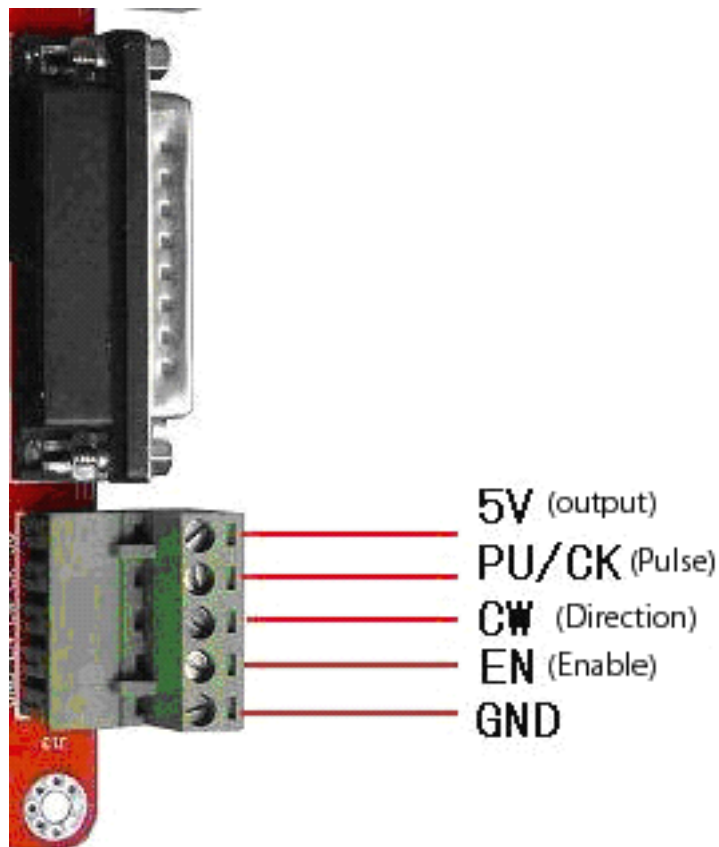

10. Drive board and motor match:

The driver can drive two or four phase stepper motors, motor drive in order to obtain the most satisfactory results, need to select a reasonable set of supply voltage and current. The supply voltage level of the decision of the high-speed electrical performance, while the current settings determine the motor output torque.

(1) A supply voltage selected:

In general, the more high of the supply voltage, the more torque in high speed, and able to avoid missing step at high speed. On the other hand, the voltage is too high may damage the driver,also big shock in low speed

(2) output current settings:

For the same motor, the greater the current set value, the greater the motor output torque, but the high heat for motor and driver. Therefore, the general situation is that the current is set to supply long-term work machine when warm but not too hot when the values.

1)when 4 or 6 lead wires stepper motors in high-speed mode: the output current is set to equal or slightly less than the motor rated current value;

2) when 6 lead wires stepper motor in high torque mode: the output current is set to 70% of motor rated current

3) 8 -wire motor connected in series: the output current is set to 70% of motor rated current

4) 8 -wire motor parallel connection: the output current can be set to 1.4 times more than the motor rated current.

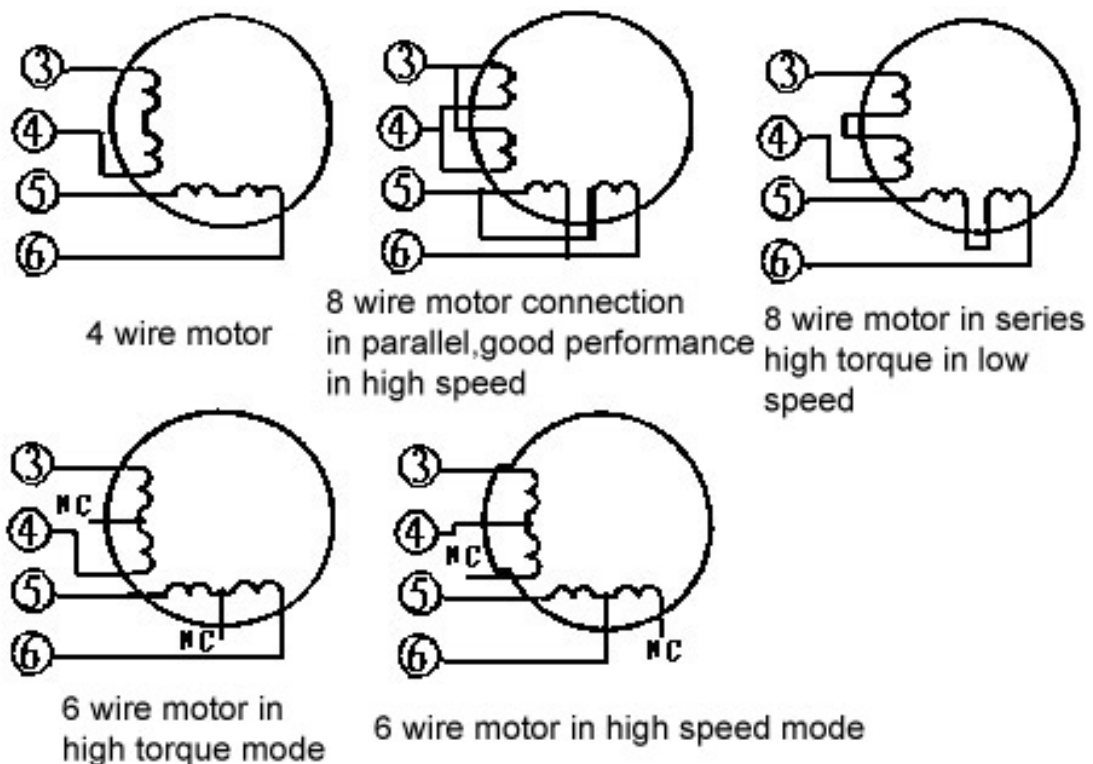

Note: The current setting 15-30 minutes after you run motors, such as the motor

temperature is too high, it should reduce the current settings.if after reducing the current value, the motor output torque is not enough, please improve the cooling conditions to ensure that motors and drives are not hot.

11. MACH3 software use introduction:

11.1、Mach3 activate:

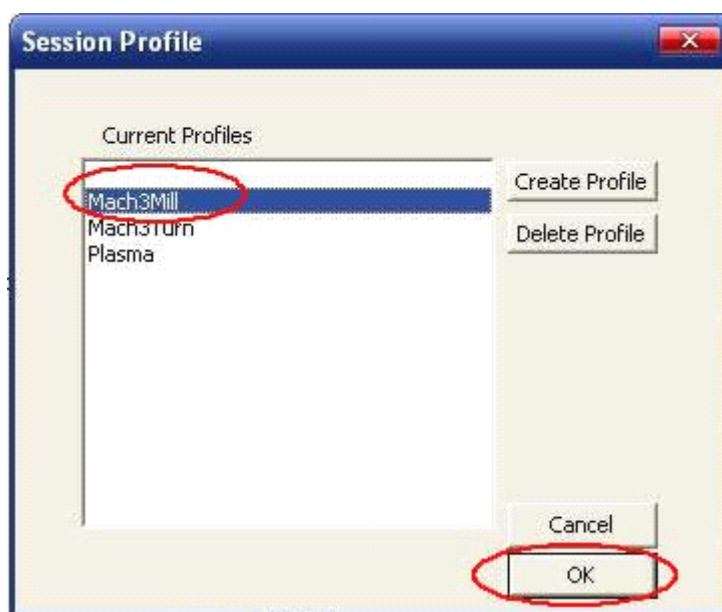

Fig1 open MACH3

Shown in Fig1, open the MACH3 software, and then select mach3MILL then OK!

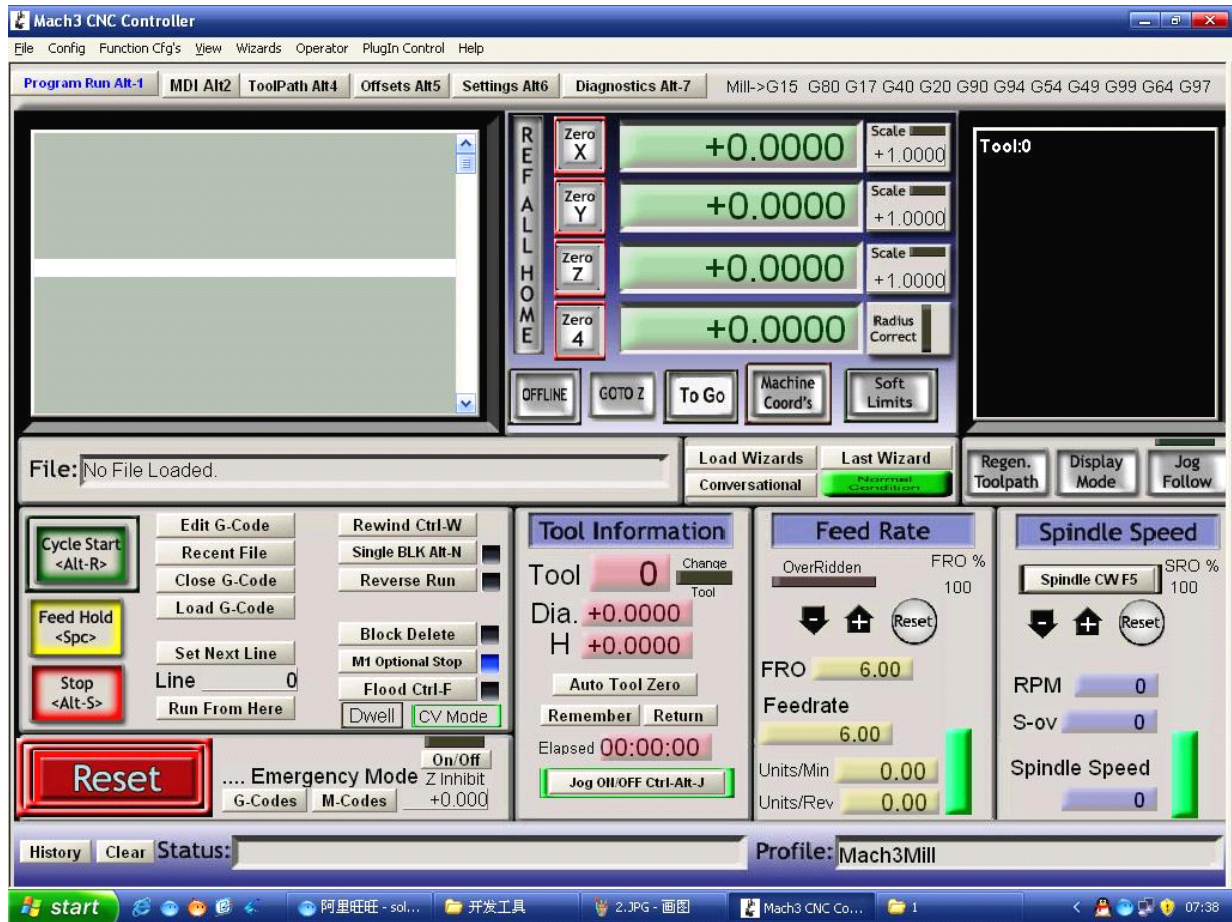

Fig 2 mach3 main table

Open the MACH3 as Fig2, there are some common buttons,then let us set up it!

11.2、Mach3 software setting:

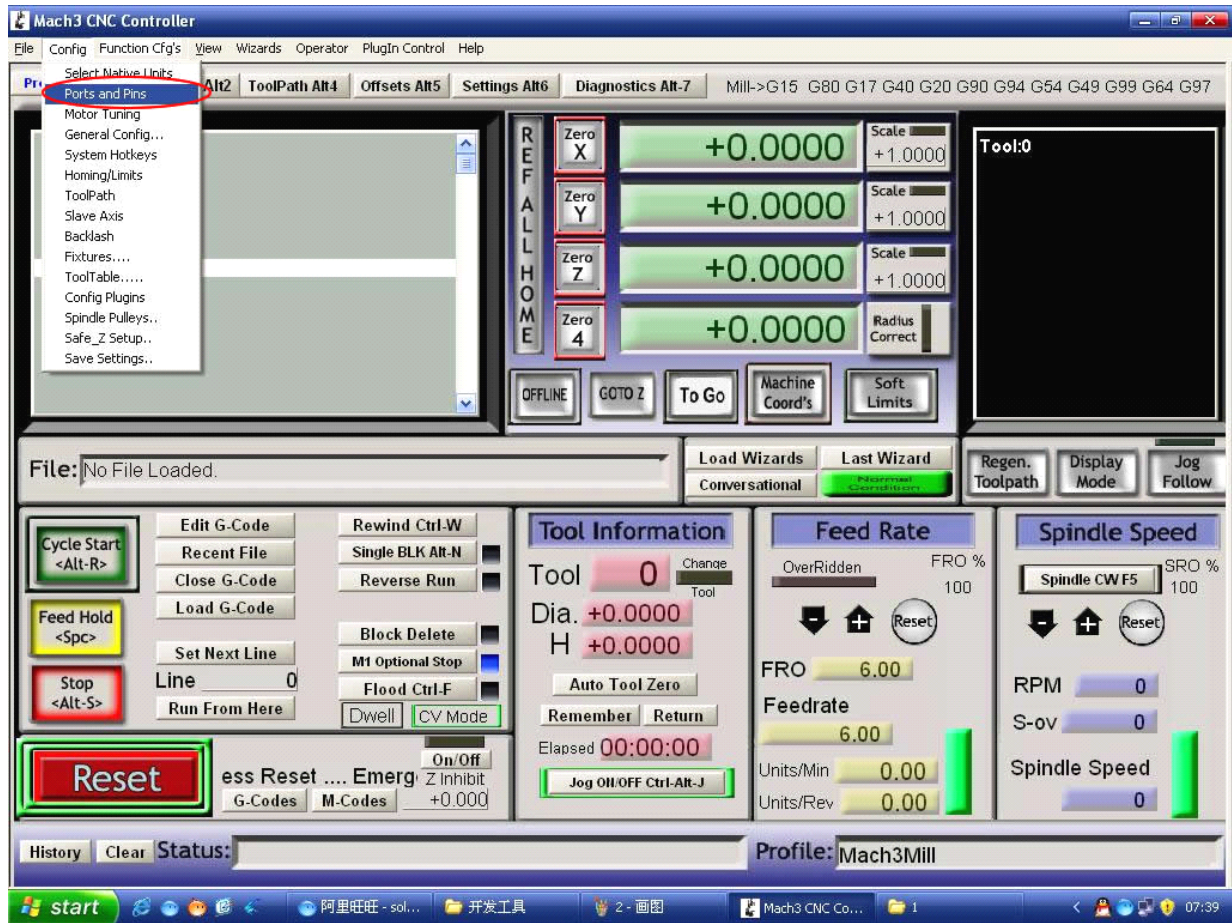

Fig 3 mach3 setting menu

Shown in Fig3, open the CONFIG menu under the PORT & PIN menu.

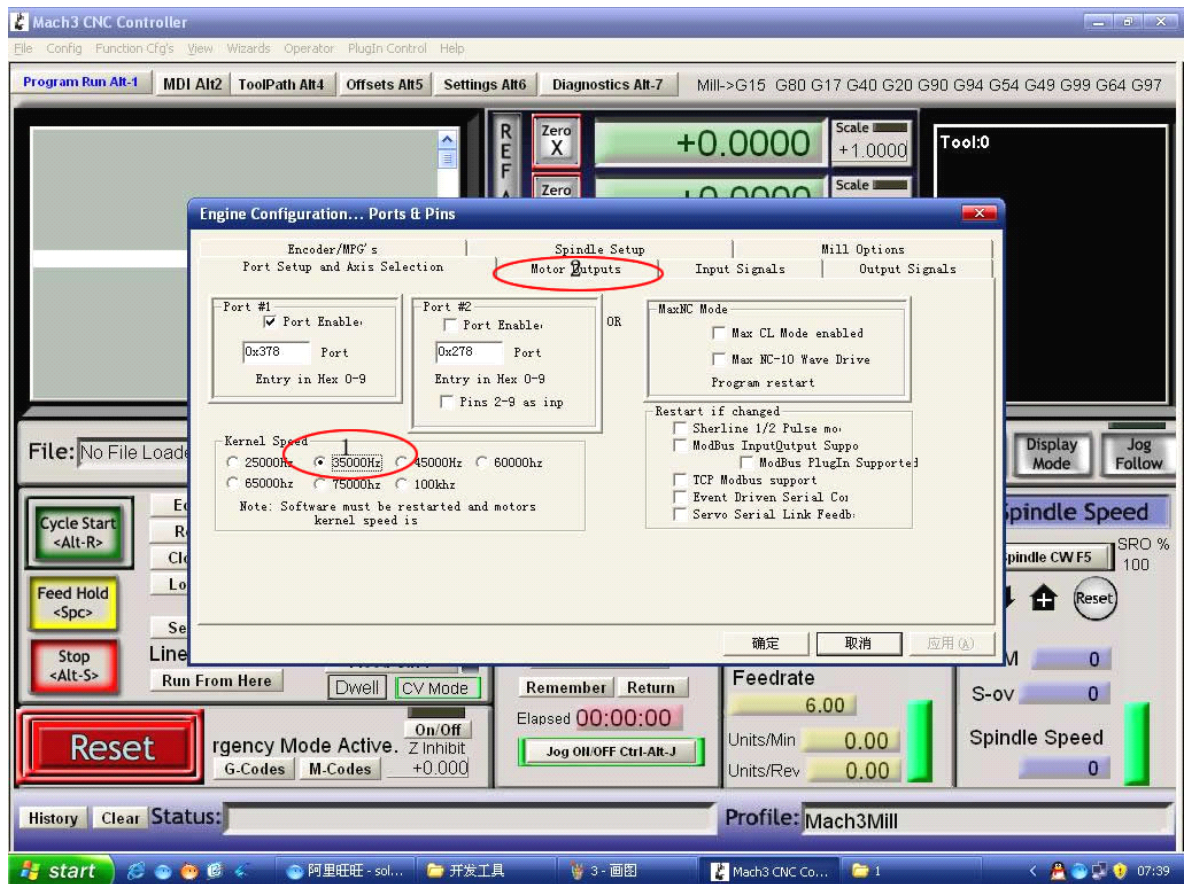

Fig 4 frequency setting

Circle 1 is for setting the fundamental frequency, this parameter affect the motor rotation speed. Set up and select Circle 2, then will shown in below Fig5 to set up the Pulse and Direction.

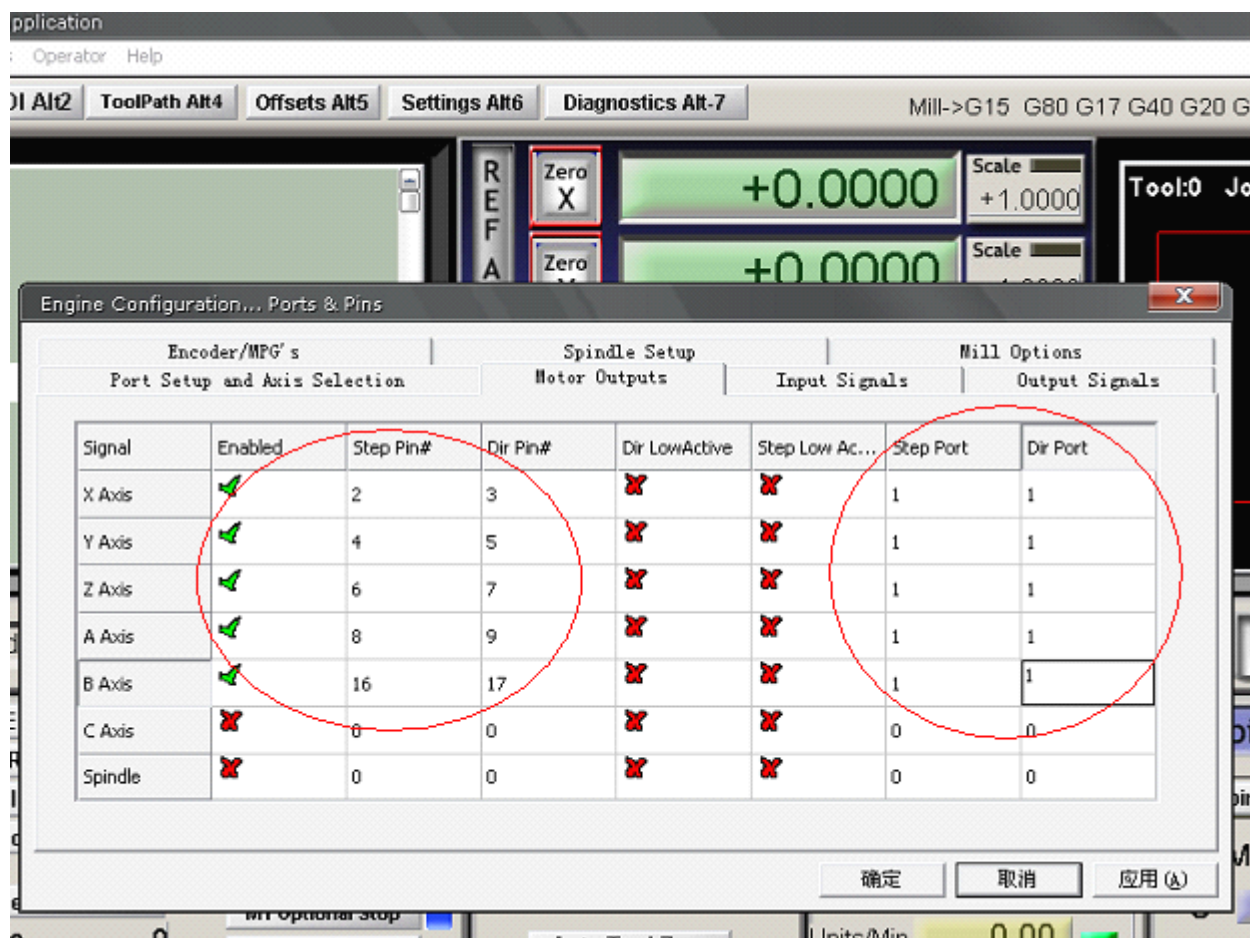

Fig 5 The pin setting of Dir,Step

Pls click “output signals” as below Fig6 after set up the Dir and Step to set up the Encoder and Relay.

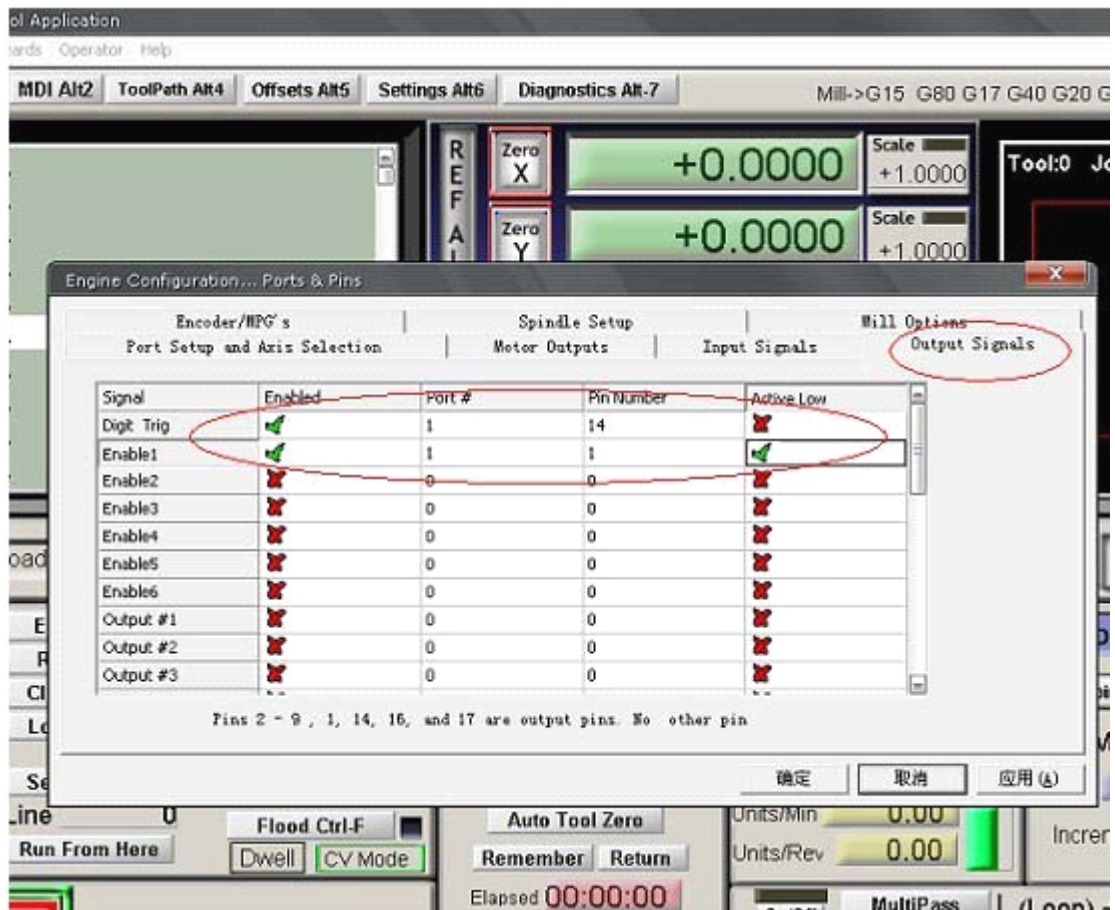

Fig 6 En and spindle relay Pin setting

11.3、 Limit switch mach3 setting:

Click "input signal", setting as Fig7

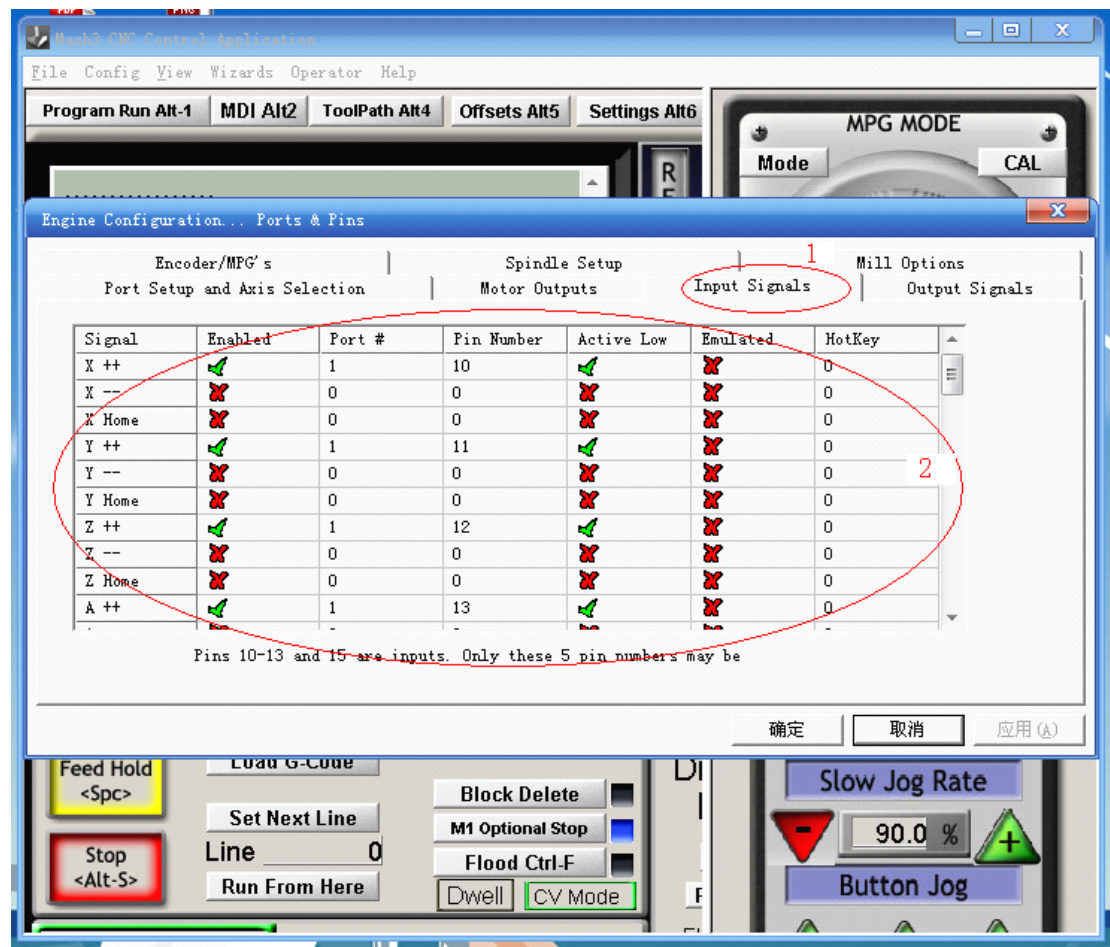

Fig 7

11.4、G-Code run:

G code is the instruction of CNC procedures,mach3 software self with G code for customer testing machine easier,click menu"File" as Fig 8.



图 8 打开 G 文件

Click “Load G-code” , then open the file which contain the MACH3

software  Mach3 , click G code file  GCode to chose a G code as Fig 9.

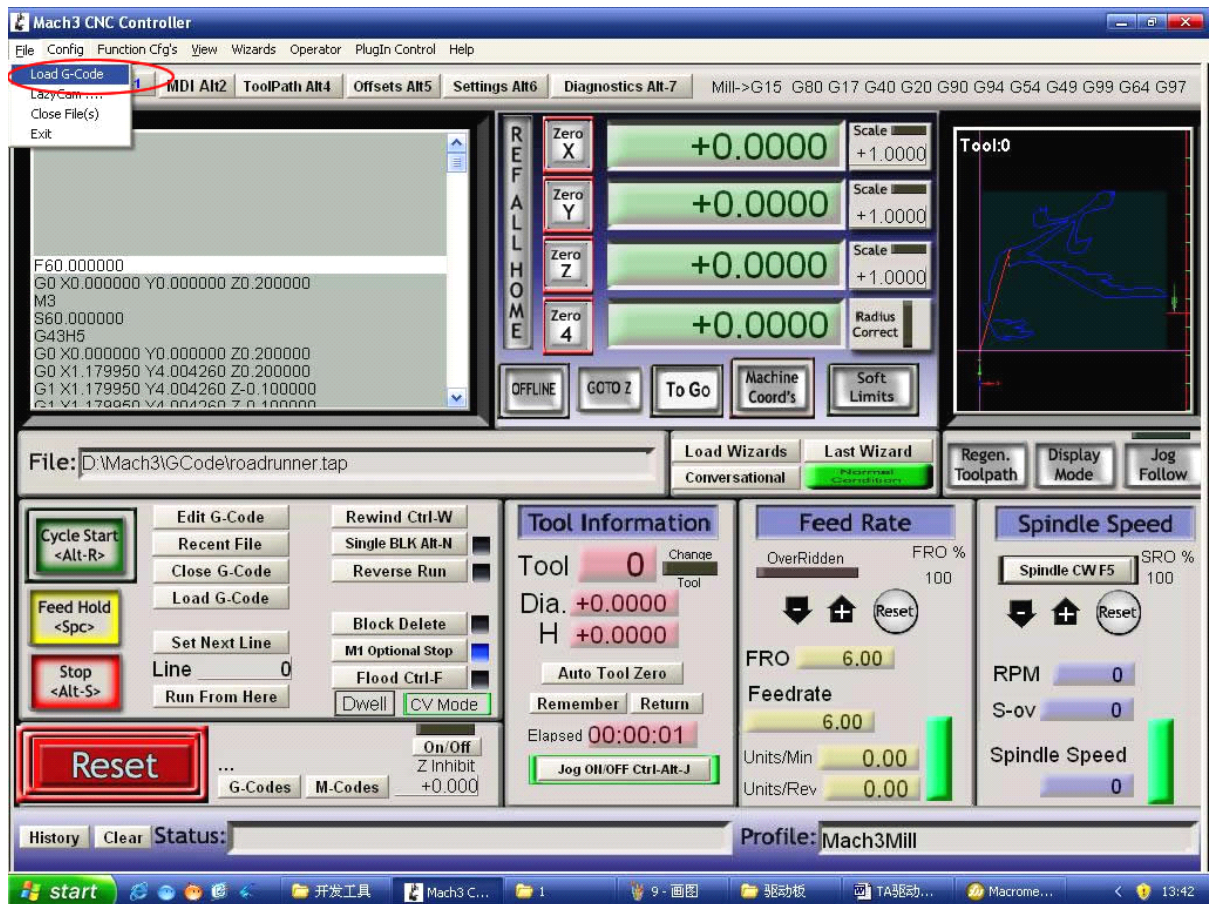
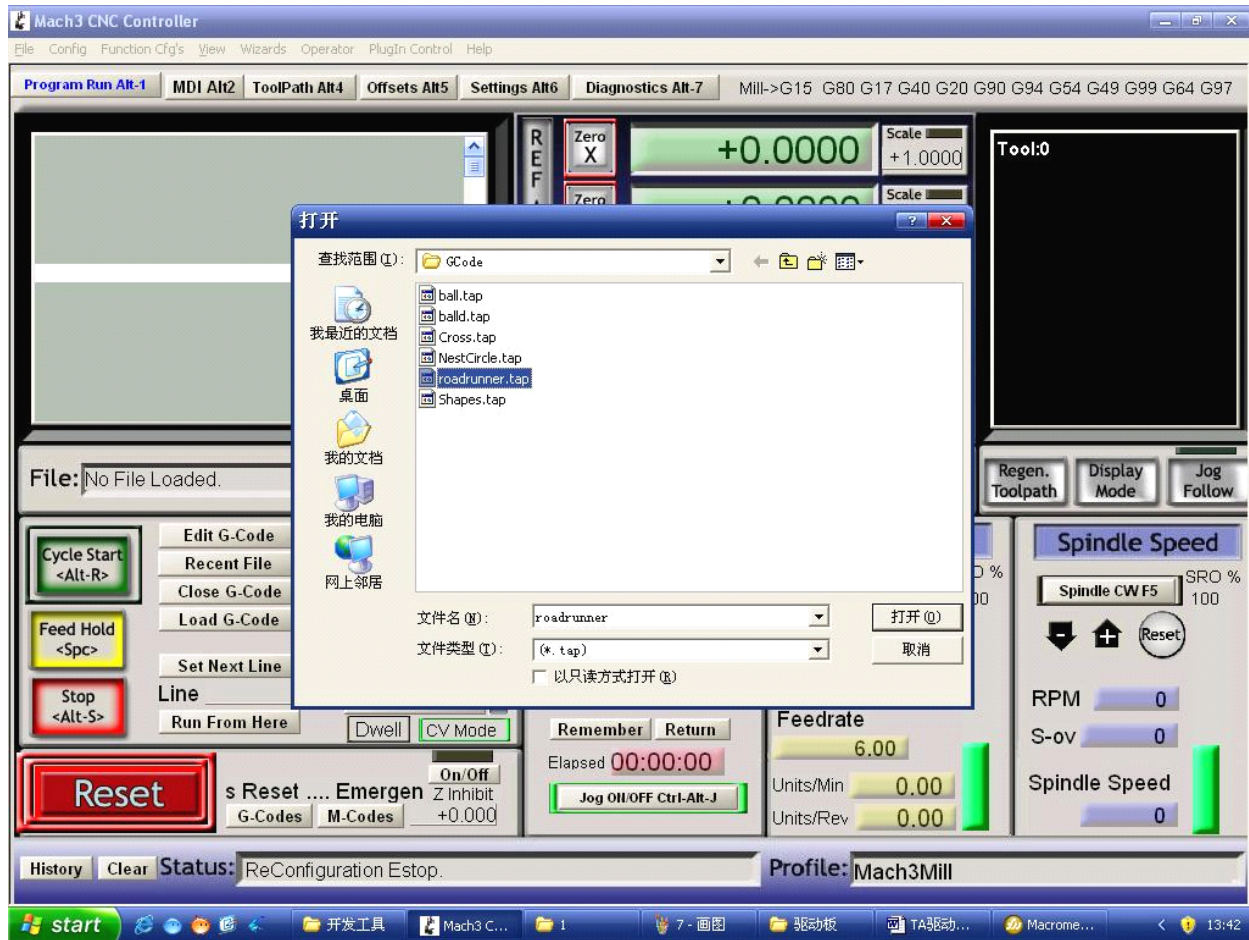

Fig 9 Open MACH3 with self G code testing procedures

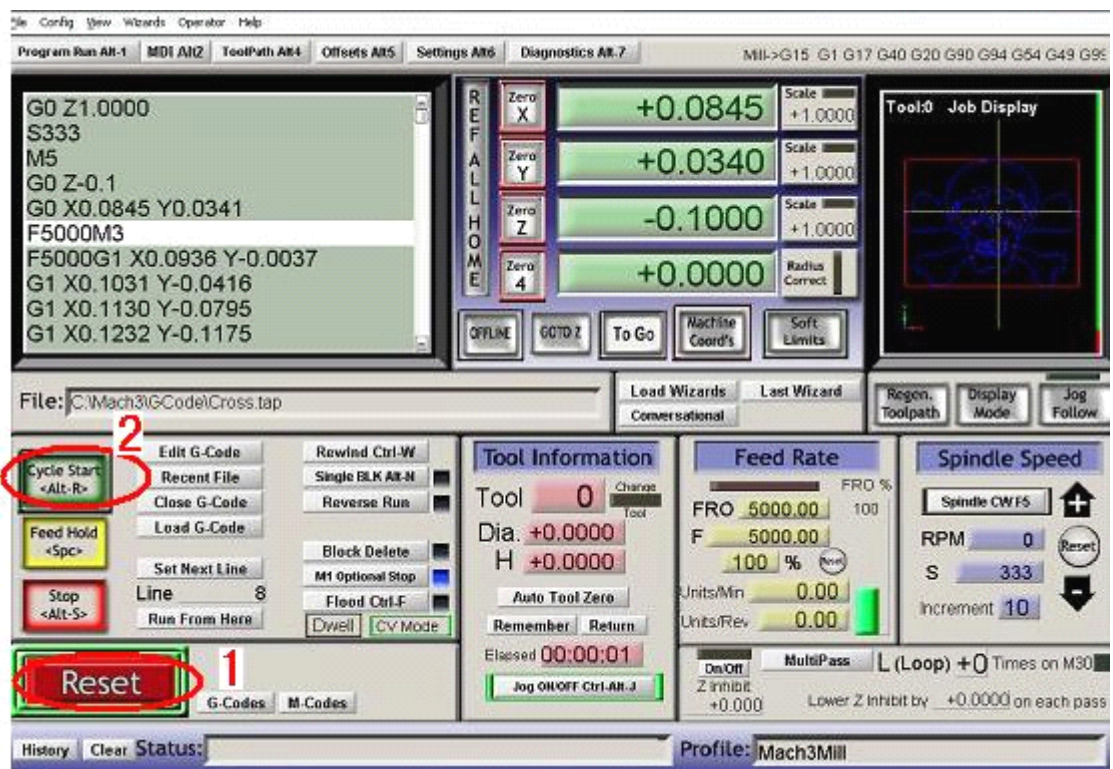

Fig 10

Open the G code, you can see the red RESET flashing, you can use mouse click the RESET to stop the flashing, then you can press circle 2 position CYCLESTART run.

If you want to run yourself G code,the way is same,to find yourself G code file then open the code is ok.

Also if you need to manual, then you can press TAB key to open the manual control panel as Fig 11

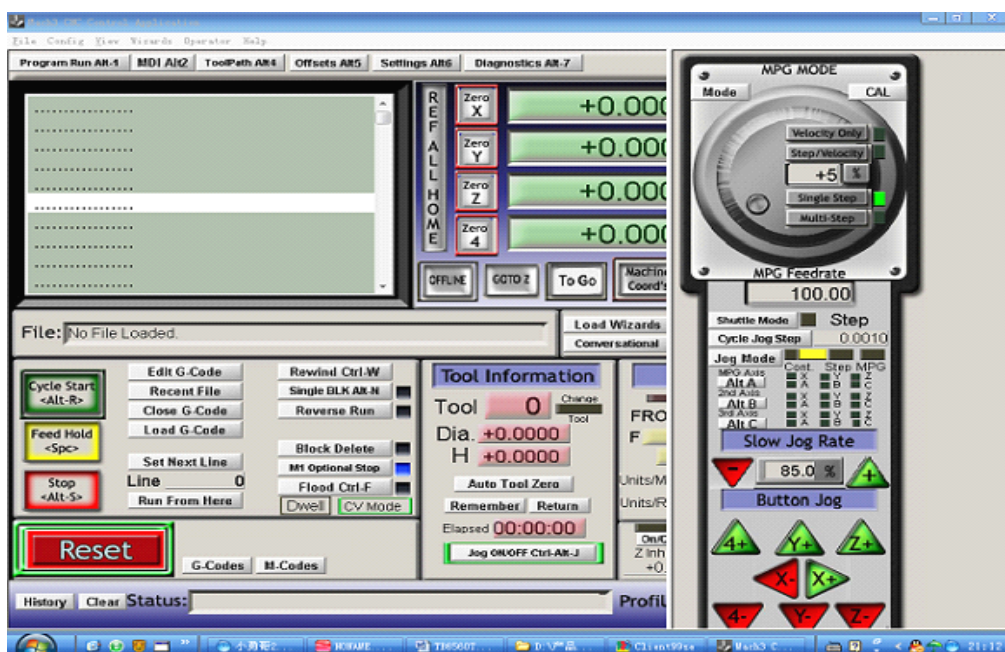

Fig 11