

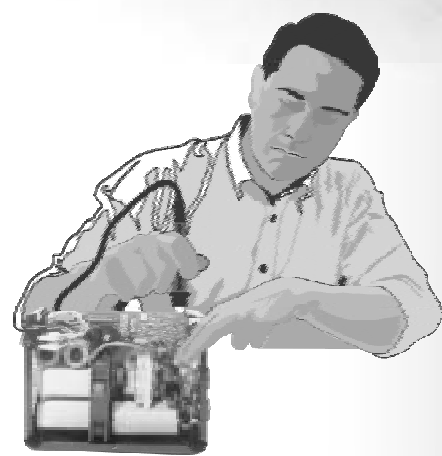

TECNICA 141-161

inverter



TROUBLESHOOTING AND REPAIR MANUAL

CONTENTS

PAGE

OPERATION AND WIRING DIAGRAMS.....	2
Block diagram	2
Analysis of the block diagram	3
Illustrations	5
Wiring diagrams	6
REPAIR GUIDE.....	10
Equipment required	10
General repair instructions	11
Troubleshooting and remedies	11
Testing the machine	14
Illustrations	16
SPARE PARTS LIST.....	17
REPAIR SHEET.....	19



"reparation no problem!"

OPERATION AND WIRING DIAGRAMS

BLOCK DIAGRAM

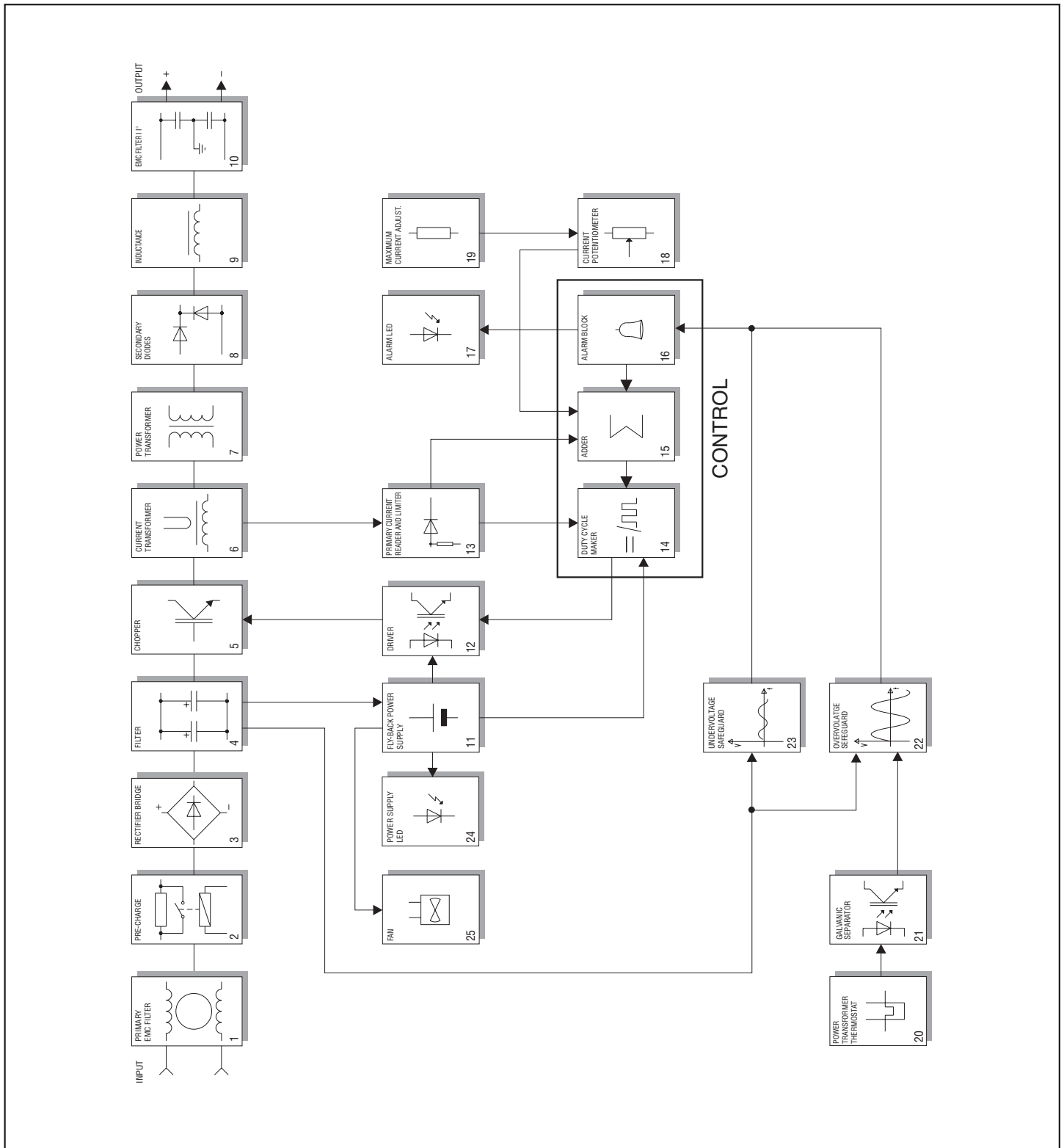

ANALYSIS OF THE BLOCK DIAGRAM

NOTE: Unless indicated otherwise, it should be assumed that the components are assembled on the power board.

Block 1

EMC Filter

Consisting of: C1, L1, C5, C6.
Prevents noise from the machine from being transmitted along the main power line and vice versa.

Block 2

Pre-charge

Consisting of: K1, R1.
Prevents the formation of high transitory currents that could damage the main power switch, the rectifier bridge and the electrolytic capacitors.
When the power source is switched on the relay K1 is de-energised, capacitors C2, C3, C4 are then charged by R1. When the capacitors are charged the relay is energised.

Block 3

Rectifier bridge

Consisting of: D1.
Converts the mains alternating voltage into continuous pulsed voltage.

Block 4

Filter

Consisting of: C2, C3, C4.
Converts the pulsed voltage from the rectifier bridge into continuous voltage.

Block 5

Chopper

Consisting of: Q1, Q2.
Converts the continuous voltage from the filter into a high frequency square wave capable of piloting the power transformer.
Regulates the power according to the required welding current/voltage.

Block 6

Current transformer

Consisting of: T2.
The C.T. is used to measure the current circulating in the power transformer primary and transmit the information to block 14 (primary current reader and limiter).

Block 7

Power transformer

Consisting of: T3.
Adjusts the voltage and current to values required for the welding procedure. Also forms galvanic separation of the primary from the secondary (welding circuit from the power supply line).

Block 8

Secondary diodes

Consisting of: D21, D22, D23.
D21 converts the current circulating in the transformer to a single direction, preventing saturation of the nucleus.
D22, D23 recirculate the inductance output current (block 9) when the IGBT's are not conducting, bypassing the power transformer (block 7).

Block 9

Inductance

Consisting of: L2.
Levels the secondary board diodes' output current making it practically continuous.

Block 10

Secondary EMC Filter

Consisting of: C31, C32.
Prevents noise from the power source from being transmitted through the welding cables and vice versa.

Block 11

Flyback power supply

Consisting of: T1, U2.
Uses switching methods to transform and stabilise the voltage obtained from block 4 (filter) and supplies auxiliary voltage to power block 12 (driver) and the control board correctly.

Block 12

Driver

Consisting of: ISO2, ISO3.
Takes the signal from block 11 (flyback power supply) and, controlled by block 14 (duty cycle maker), makes the signal suitable for piloting block 6 (chopper).

Block 13

Primary current reader and limiter

Consisting of: R20, R37, R38 and part of the control section.
Reads the signal from block 6 (current transformer) and scales it down so it can be processed and compared in blocks 14 and 15.

Block 14

Duty cycle maker

Consisting of: U2 (control board).
Processes the information from block 15 (adder) and block 13 (primary current reader and limiter) and produces a square wave with variable duty cycle limiting the primary current to a maximum pre-set value under all circumstances.

Block 15

Adder

Consisting of: U1C (control board).
Gathers all the information from block 13 (primary current reader and limiter), from block 16 (alarms) and from block 18 (current potentiometer), and produces a signal with a suitable voltage for processing by block 14 (duty cycle maker).

Block 16

Alarm Block

Consisting of: U1A, U1B (control board).
When an alarm is detected the power source output current is drastically reduced by making direct adjustments to block 14 (duty cycle maker) and directly changing the reference signal obtained from block 18 (current potentiometer).

Block 17

Alarm LED

Consisting of: D26.
It is switched on by block 16 (alarms) in the event of:

- 1) Triggering of thermostatic capsule/thermostat on power transformer.
- 2) Triggering due to undervoltage.
- 3) Triggering due to overvoltage.
- 4) Short circuit at output (electrode holder clamp and earth cable connected to one another or electrode stuck to piece being welded).

Block 18

Current potentiometer

Consisting of: R7.

This is used to set the reference voltage needed to adjust the output current: when the potentiometer knob is turned the cursor voltage varies, thus varying the current from the minimum to the maximum value.

Block 19

Maximum current adjustment

Consisting of: R32, R33, R42.

Used to adjust the maximum cutting current to be supplied by the power source.

Block 20

Power transformer thermostat

Consisting of: ST1.

When the temperature of the power transformer is too high, this safeguard is triggered. It is reset automatically after the alarm condition has ceased.

Block 21

Galvanic separator

Consisting of: ISO1.

The signal arriving from block 20 (power transformer thermostat) is separated galvanically and sent to block 16 (alarms) for detection of a possible alarm event.

Block 22

Overvoltage safeguard

Consisting of: R3, R4 and part of the control section.

If the main supply voltage exceeds the maximum value this safeguard triggers (a tolerance of approx. $\pm 15\%$ of the power supply voltage is allowed: outside this range the safeguard triggers).

Block 23

Undervoltage safeguard

Consisting of: R5, R6 and part of control board.

If the main supply voltage falls below the minimum allowed value this safeguard triggers (a tolerance of approx. $\pm 15\%$ of the power supply voltage is allowed: outside this range the safeguard triggers).

Block 24

Power supply LED

Consisting of: D2.

Indicates when the power source is correctly powered and ready for use.

Block 25

Fan

Consisting of: V1.

Powered directly by block 11 (flyback transformer) and cools the power components.

ILLUSTRATIONS

Power board

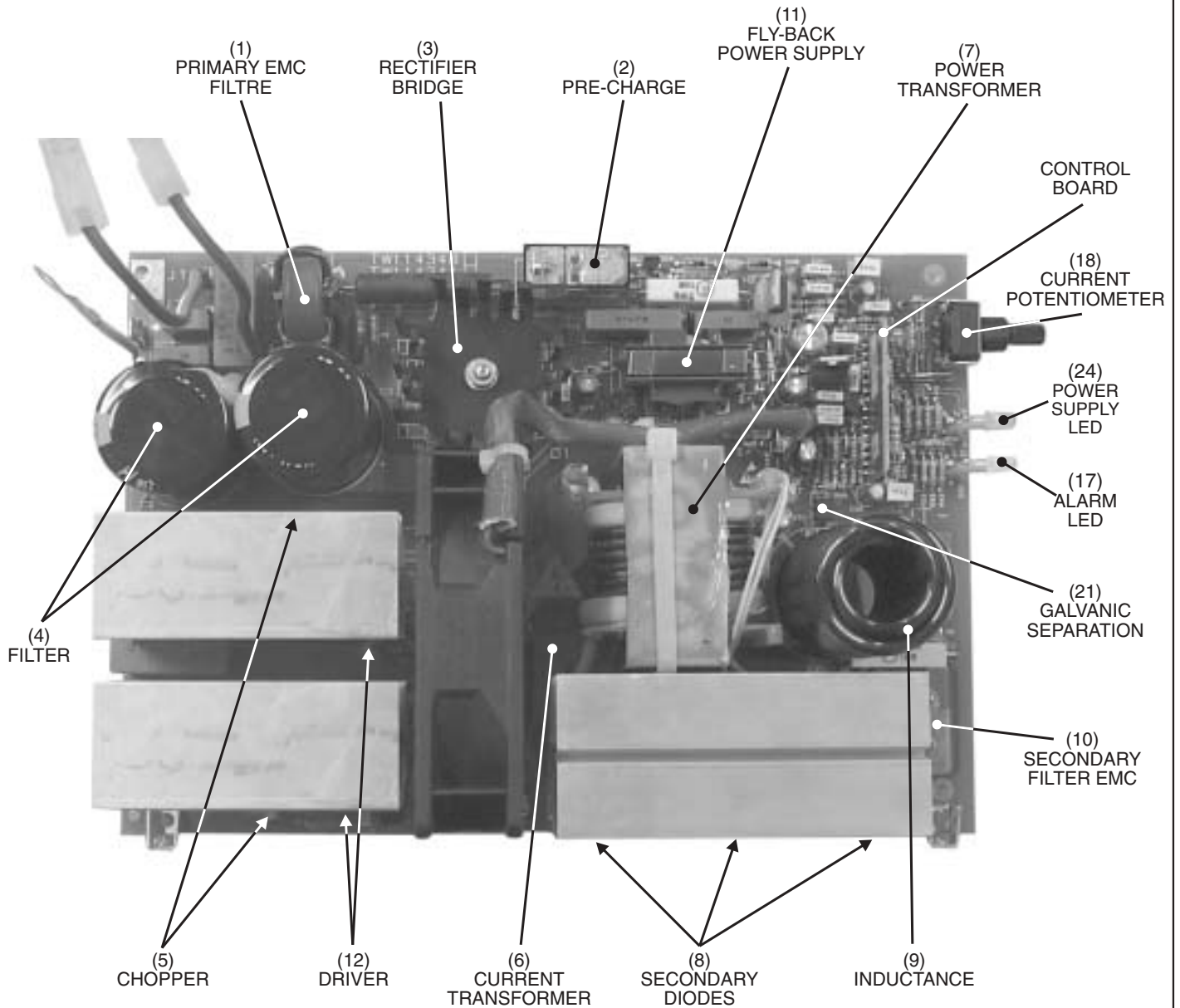

WIRING DIAGRAMS

General wiring diagram

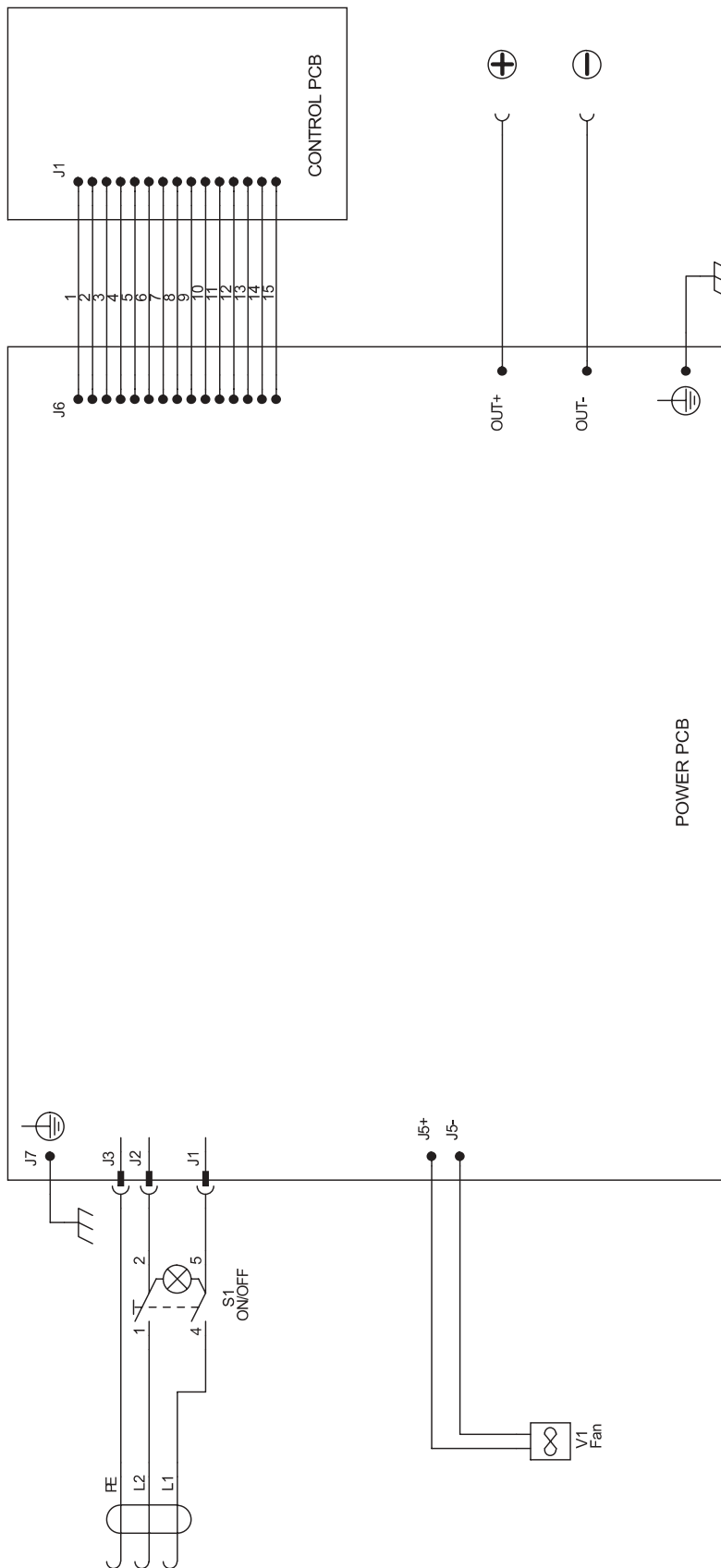

Wiring diagram for power – power supply/control board

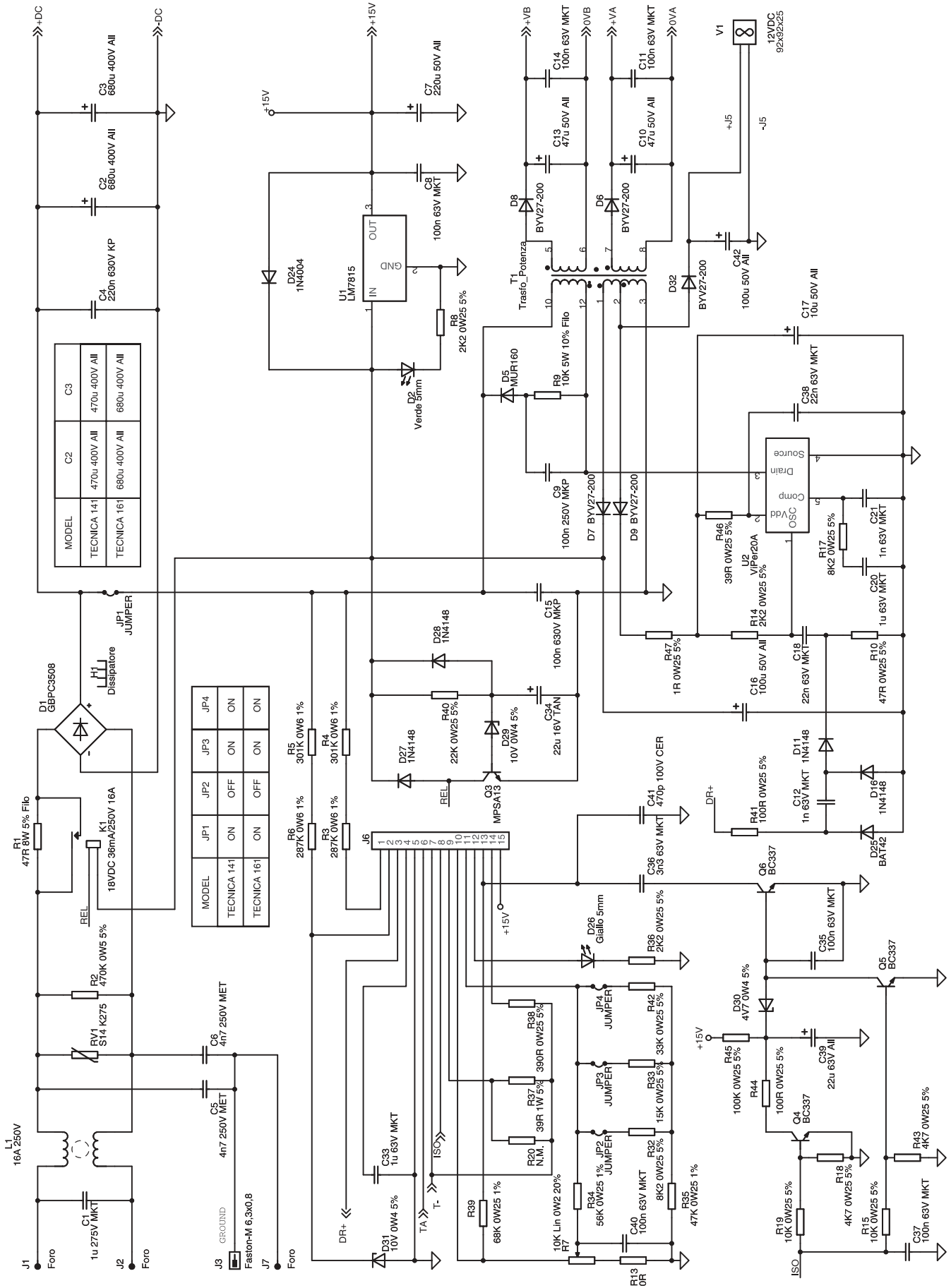

Wiring diagram for control board

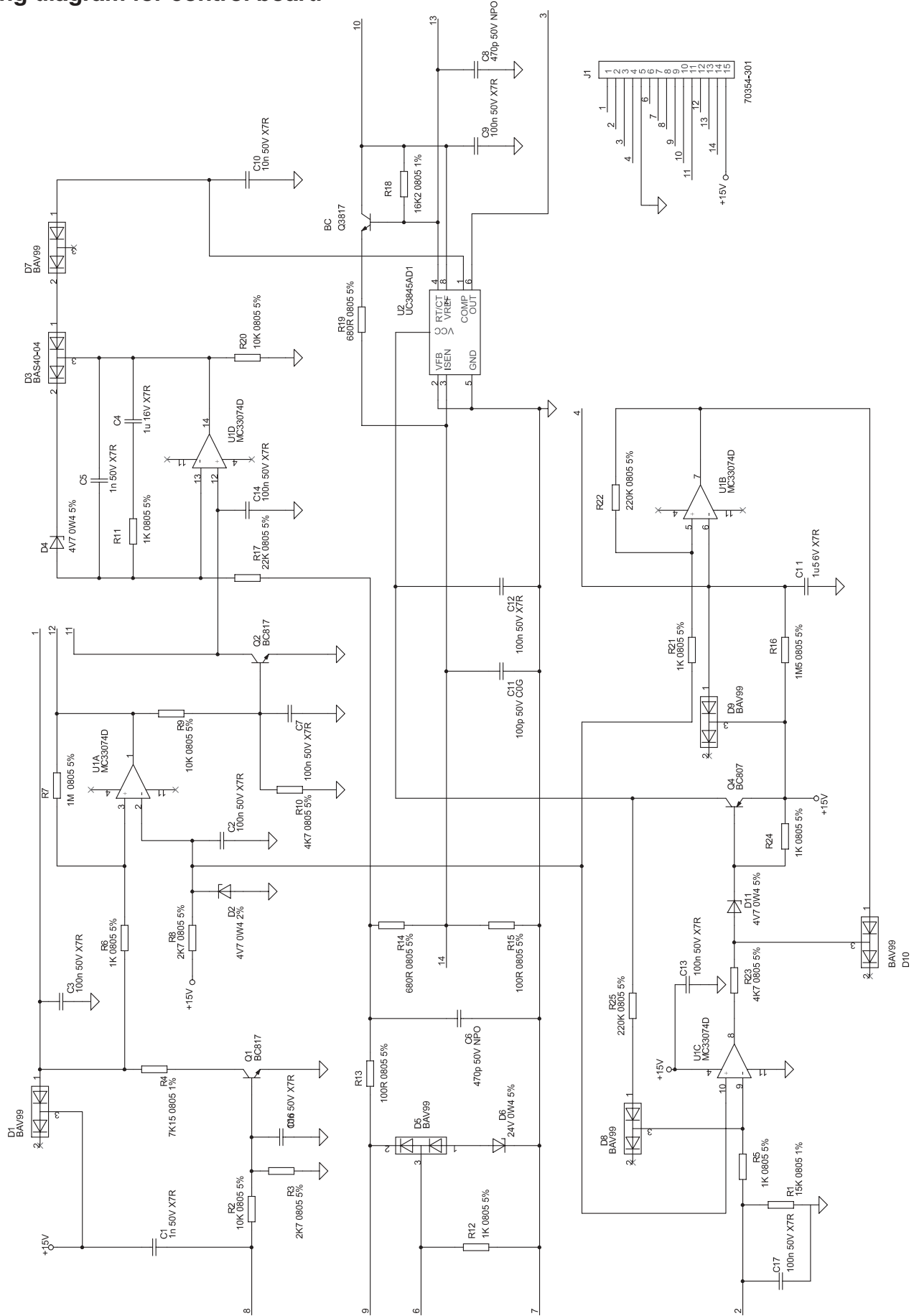

REPAIR GUIDE

EQUIPMENT REQUIRED

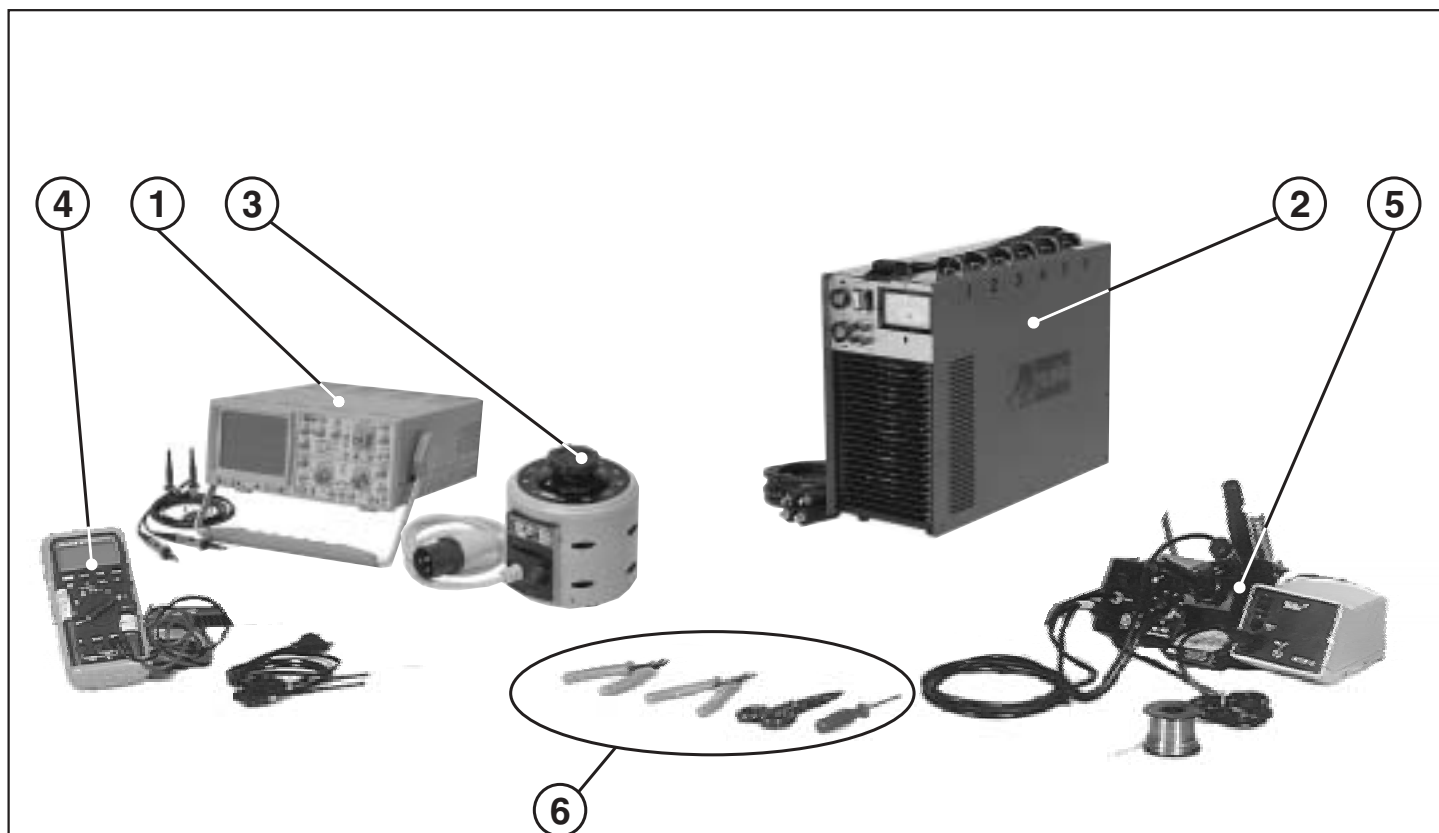

ESSENTIAL INSTRUMENTS

- | | |
|----------------------------------|------------------------|
| 1 Dual trace oscilloscope | cod. 802401 (*) |
| 2 Static load generator | cod. 802110 (*) |
| 3 Variac 0 - 300v 1500 VA | cod. 802402 (*) |
| 4 Digital multimeter | |

USEFUL INSTRUMENTS

- 5** Unsoldering station
- 6** Miscellaneous tools

(*)The instruments with codes can be supplied by Telwin. The sale price is available on request.

**WARNING:**

BEFORE PROCEEDING WITH REPAIRS TO THE MACHINE READ THE INSTRUCTION MANUAL CAREFULLY.

WARNING:

EXTRAORDINARY MAINTENANCE SHOULD BE CARRIED OUT ONLY AND EXCLUSIVELY BY EXPERT OR SKILLED ELECTRICAL-MECHANICAL PERSONNEL.

WARNING:

ANY CHECKS CARRIED OUT INSIDE THE MACHINE WHEN IT IS POWERED MAY CAUSE SERIOUS ELECTRIC SHOCK DUE TO DIRECT CONTACT WITH LIVE PARTS.

GENERAL REPAIR INSTRUCTIONS

The following is a list of practical rules which must be strictly adhered to if repairs are to be carried out correctly.

- A) When handling the active electronic components, the IGBT's and Power DIODES in particular, take elementary antistatic precautions (use antistatic footwear or wrist straps, antistatic working surfaces etc.).
- B) To ensure the heat flow between the electronic components and the dissipator, place a thin layer of thermo-conductive grease (e.g. COMPOUND GREASIL MS12) between the contact zones.
- C) The power resistors (should they require replacement) should always be soldered at least 3 mm above the board.
- D) If silicone is removed from some points on the boards, it should be re-applied.
N.B. Use only non-conducting neutral or oximic reticulating silicones (e.g. DOW CORNING 7093). Otherwise, silicone that is placed in contact with points at different potential (rheophores of IGBT's, etc.) should be left to reticulate before the machine is tested.
- E) When the semiconductor devices are soldered the maximum temperature limits should be respected (normally 300°C for no more than 10 seconds).
- F) It is essential to take the greatest care at each disassembly and assembly stage for the various machine parts.
- G) Take care to keep the small parts and other pieces that are dismantled from the machine so as to be able to position them in the reverse order when re-assembling (damaged parts should never be omitted but should be replaced, referring to the spare parts list given at the end of this manual).
- H) The boards (repaired when necessary) and the wiring should never be modified without prior authorisation from Telwin.
- I) For further information on machine specifications and operation, refer to the Instruction Manual.
- J) **WARNING!** When the machine is in operation there are dangerously high voltages on its internal parts so do not touch the boards when the machine is live.

TROUBLESHOOTING AND REMEDIES**1.0 Disassembling the machine**

Every operation should be carried out in complete safety with the power supply cable disconnected from the mains outlet and should only be done by expert or skilled electrical-mechanical personnel.

- undo the 4 screws attaching the handle to the top cover (**Fig. 1**);
- undo the 2 screws fastening the two plastic shells to the base: 1 screw on each side (**Fig. 1**);
- undo the 2 screws attaching the handle to the base: 1 screw on each side (**Fig. 1**);
- on the top cover undo the nut for the earth connection (J7);
- slide out the top cover upwards (**Fig. 1**);
- undo the two screws fastening the power board to the base.

After completing the repairs, proceed in the reverse order to re-assemble the cover and do not forget to insert the toothed washer on the ground screw.

2.0 Cleaning the inside of the machine

Using suitably dried compressed air, carefully clean the components of the power source since dirt is a danger to parts subject to high voltages and can damage the galvanic separation between the primary and secondary.

To clean the electronic boards we advise decreasing the air pressure to prevent damage to the components.

It is therefore important to take special care when cleaning the following parts

Fan (fig. 2A)

Check whether dirt has been deposited on the front and back air vents or has damaged the correct rotation of the blades, if there is still damage after cleaning replace the fan.

Power board (figs. 2A and 2B):

- rheofores of IGBT's Q1, Q2;
- rheofores of recirculating diodes D14, D20;
- rheofores of secondary power diodes D21, D22, D23;
- thermostat ST1 on power transformer;
- opto couplers ISO1;
- control board.

3.0 Visual inspection of the machine

Make sure there is no mechanical deformation, dent, or damaged and/or disconnected connector.

Make sure the power supply cable has not been damaged or disconnected internally and that the fan works with the machine switched on. Inspect the components and cables for signs of burning or breaks that may endanger operation of the power source. Check the following elements:

Main power supply switch (fig. 2A)

Use the multimeter to check whether the contacts are stuck together or open. Probable cause:

- mechanical or electric shock (e.g. bridge rectifier or IGBT in short circuit, handling under load).

Current potentiometer R7 (fig. 3)

Probable cause:

- mechanical shock.

Relay K1 (fig. 3)

Probable cause:

- see main power supply switch. **N.B.** If the relay contacts are stuck together or dirty, do not attempt to separate them and clean them, just replace the relay.

Electrolytic capacitors C2, C3 (fig. 3)

Probable cause:

- mechanical shock;
- machine connected to power supply voltage much higher than the rated value;

- broken rheophore on one or more capacitor: the remainder will be overstressed and become damaged by overheating;
- ageing after a considerable number of working hours;
- overheating caused by thermostatic capsule failure.

IGBT's Q1, Q2 (fig. 4)

Probable cause:

- discontinuation in snubber network;
- fault in driver circuit;
- poorly functioning thermal contact between IGBT and dissipator (e.g. loosened attachment screws: check);
- excessive overheating related to faulty operation.

Primary diodes D14, D20 (fig. 4)

Probable cause:

- excessive overheating related to faulty operation.

Secondary diodes D21, D22, D23 (fig. 4)

Probable cause:

- discontinuation in snubber network;
- poorly functioning thermal contact between IGBT and dissipator (e.g. loosened attachment screws: check);
- faulty output connection.

Power transformer and filter reactance (fig. 2A)

4.0 Checking the power and signal wiring

It is important to check that all the connections are in good condition and the connectors are inserted and/or attached correctly. To do this, take the cables between finger and thumb (as close as possible to the fastons or connectors) and pull outwards gently: the cables should not come away from the fastons or connectors. N.B. If the power cables are not tight enough this could cause dangerous overheating.

In particular, on the **power board (fig. 2A)** it is necessary to check the power wiring:

- the connection of the power supply cable to the fastons at the main switch and to the earth faston (J3) on the power board;
- the connections from the power board to the main switch (J1, J2);
- the connections of the thermostat to the power transformer (ST1);
- the fan connections (+J5, -J5).

Other checks:

Make sure that the connections to the (+) and (-) dinse sockets are attached correctly to the power board (**Fig. 2B**).

5.0 Electrical measurements with the machine switched off

A) With the multimeter set in **diode testing** mode check the following components (junction voltages not less than 0.2V):

- rectifier bridge D1 (**fig. 3**);
- IGBT's Q1, Q2 (absence of short circuits between collector-gate and between emitter-collector **fig. 4**);
- secondary board diodes D21, D22, D23 between anode and cathode (**fig. 4**). The secondary diodes can be checked without removing the power board: with one prod on the secondary board dissipator diodes and the other in sequence on the two power transformer outlets;
- viper U2 (absence of short circuits between pin 3 - pin 4 and between pin 4 pin 2, **fig. 3**).

B) With the multimeter set in ohm mode check the following components:

- resistor R1: 47ohm (pre-charge **fig. 3**);
- resistors R21, R27: 22ohm (primary snubber **fig. 3**);
- resistor R31: 10ohm (secondary snubber **fig. 3**);
- thermostat continuity test on the power transformer: clean the resin from the bump contacts of ST1 and measure the resistance between the two bump contacts, it should be approx. 0 ohm (**fig. 2B**).

6.0 Electrical measurements with the machine in operation

WARNING! Before proceeding with faultfinding, we should remind you that during these tests the power source is powered and therefore the operator is exposed to the danger of electric shock.

The tests described below can be used to check the operation of the power and control parts of the power source.

6.1 Preparation for testing

A) Set up the oscilloscope with the voltage probe x100 connected between pin 3 of U2 (probe) and the case of U1 (earth) on the power board (**Fig. 3**).

B) Set up the multimeter in DC mode and connect the prods to the OUT+ and OUT- bump contacts.

C) Position the potentiometer R42 on maximum (turn clockwise as far as it will go).

D) Connect the power supply cable to a single-phase variac with variable output 0-300 Vac.

6.2 Tests for the TECNICA 141

A) Switch on the variac (initially set to the value 0 V), switch off the main switch on the power source and increase the variac voltage gradually to 230 Vac and make sure:

- the green power supply LED D2 lights up (**fig. 3**),
- the fan for the power transformer starts up correctly,
- the pre-charge relay K1 commutes (**fig. 3**),
- for voltages close to the rated power supply value (230Vac $\pm 15\%$) the power source is not in alarm status (yellow LED D26 off).

NB. if the power source stays in alarm status permanently, there could be a fault in the control board (in any case, proceed to make the other tests)

B) Make sure the waveform shown on the oscilloscope resembles **Fig. A**.

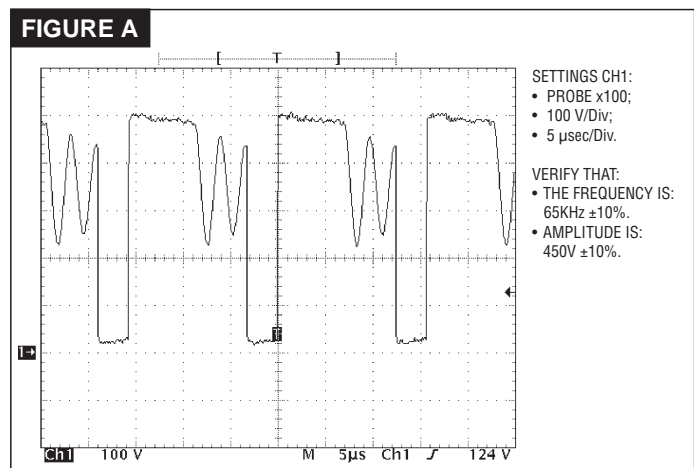

N.B. if no signal is present, it may be necessary to replace the integrated circuit U2 (**fig. 3**).

C) With the multimeter set in **volt** mode make sure that (**fig. 3**):

- the voltage between connector J9 (-) and the cathode of diode D32 (+) is equal to +13V $\pm 5\%$ (**fig. 3**);
- the voltage over pin 2 of U2 the earth is equal to +13V $\pm 5\%$;
- the voltage over pin 1 and pin 2 of U1 is equal to +18V $\pm 3\%$;
- the voltage over pin 3 and pin 2 of U1 is equal to +15V $\pm 3\%$;
- the voltage over the ends of capacitor C10 is equal to +29V $\pm 5\%$;
- the voltage over the ends of capacitor C13 is equal to +29V $\pm 5\%$.

D) Set up the dual trace oscilloscope. Connect the probe CH1(x100) to the Q1 collector and probe CH2(x10) to the gate, also of Q1. The earth connections are both made to the emitter of Q1.

E) Make sure the waveform displayed on the oscilloscope resembles **fig. B**.

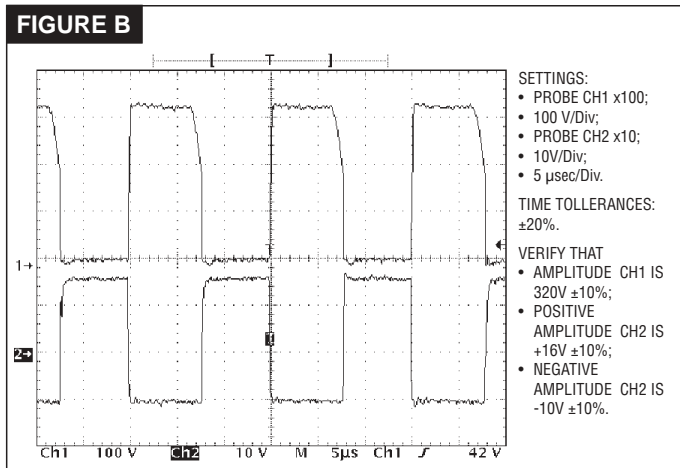

F) Repeat this test on Q2 as well using the differential probe. **N.B.** if the signal is not present, there may be a fault in the IGBT driver circuit (**fig. 4**) or the control board (**fig. 3**, in the latter case, we recommend replacing the board).

G) Set up the dual trace oscilloscope. Connect probe CH1 (x100) to the collector of Q1 and probe CH2 (x10) to pin 9 on strip J6. The earth terminals are connected together to the emitter of Q1.

H) Make sure the waveform displayed on the oscilloscope resembles **fig. C** and that the output voltage over OUT+ and OUT- is equal to +85Vdc±10%.

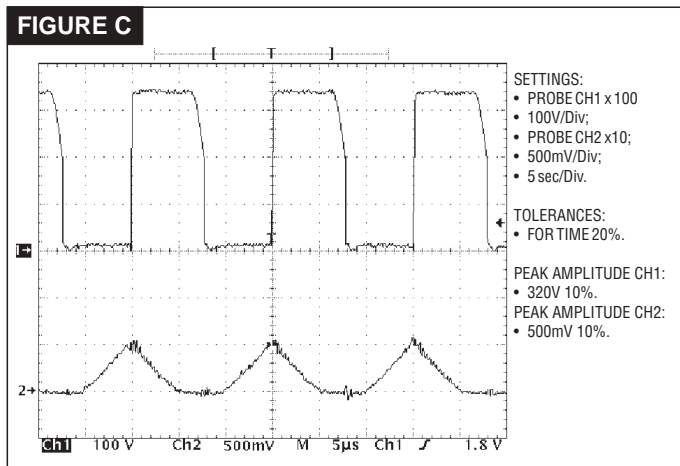

I) Switch the power source on again and make sure that, following the brief start up time, the machine is not in alarm status (the yellow alarm LED D26 is off, **fig. 3**). **N.B.** If the machine remains in alarm status (and this is not due to a fault in the control board) there could be a fault in the photocoupler ISO1 (**fig. 3**).

6.3 Tests for the TECNICA 161

WARNING! In this case the tests are just the same as for the Tecnica 141 and can be carried out in the same way.

7.0 Repairs, replacing the boards

If repairing the board is complicated or impossible, it should be completely replaced. The board is identified by a 6-digit code (printed in white on the component side after the initials TW). This is the reference code for requesting a replacement: Telwin may supply boards that are compatible but with different codes.

Warning: before inserting a new board check it carefully for damage that may have occurred in transit. When we supply a board it has already been tested and so if the fault is still present after it has been replaced correctly, check the other machine components. Unless specifically required by the procedure, never alter the board trimmers.

7.1 Removing the power board (fig. 2A)

If the fault is in the power board remove it from the bottom as follows:

- with the machine disconnected from the main supply, disconnect all the wiring connected to the board;
- remove the current adjustment knob on the front panel of the machine (**fig. 1**);
- remove any bands constraining the board (e.g. on the power supply cable and connections to primary);
- from the welding side undo the two screws fastening the dinse sockets to the printed circuit board (**fig. 2B**);
- undo the 2 screws fastening the board to the bottom (**fig. 2B**);
- undo the 2 screws fastening the board to the front and back on the inside (**fig. 2B**);
- after removing the screws, lift the board upwards to remove it from the bottom of the machine.

N.B. to re-assemble, proceed in the reverse order, remembering to insert the toothed washers on the earth screws.

A) Please read the procedure for replacing the IGBT's carefully: (fig. 4).

The 2 IGBT's are attached to 2 different dissipators and whenever a replacement is required, both IGBT's should be replaced.

- undo the screws attaching the dissipator to the board to replace Q1. (**fig. 2B**);
- undo the screws attaching the dissipator to the board to replace Q2 (**fig. 2B**);
- remove the 2 IGBT's Q1, Q2 and the 2 diodes D20, D14 by unsoldering the rheofores and then clean the solder from the printed circuit bump contacts;
- remove the 2 dissipators from the board;
- undo the screws locking the 2 IGBT's.

Before making the replacement make sure the components piloting the IGBT's are not also damaged:

- with the multimeter set in **ohm** mode make sure there is no short circuit on the PCB between the 1st and 3rd bump contacts (between gate and emitter) corresponding to each component;
- alternatively, resistors R22 and R29 could have burst and/or diodes D12, D15, D17 and D19 may be unable to function at the correct Zener voltage (this should have shown up in the preliminary tests);
- clean any irregularity or dirt from the dissipators. If the IGBT's have burst the dissipators may have been irreversibly damaged: in this case they should be replaced;
- apply thermo-conductive grease following the general instructions.- Insert the new IGBT's between the dissipator and the spring, taking care not to damage the component during assembly (the spring should be inserted under pressure on the dissipator so as to lock the component);
- place the dissipators with the new IGBT's and primary

diodes D14 and D20 (**WARNING!** Make sure there is insulation between the case of diode D20 and the dissipator) in the PCB bump contacts, placing 4 spacers between the dissipator and the PCB (2 for each dissipator) and fasten them down with the screws (torque wrench setting for screws $1 \text{ Nm} \pm 20\%$);

- solder the terminals taking care not to let the solder run along them;
- on the welding side cut away the protruding part of the rheofores and check they are not shorted (between the gate and emitter in particular).

B) Please read the procedure for replacing the secondary board diodes carefully (fig. 4):

The 3 SECONDARY DIODES are attached to the same dissipator, and when a replacement is required, all of them should be replaced:

- undo the screws attaching the dissipator to the board, to replace diodes D21, D22 and D23;
- remove the 3 secondary diodes unsoldering the rheofores and cleaning any solder from the bump contacts on the board;
- remove the dissipator from the board;
- remove the spring locking the 3 diodes;
- clean any irregularity or dirt from the dissipator. If the diodes have burst the dissipator may have been irreversibly damaged: in this case it should be replaced;
- apply thermo-conductive grease following the general instructions;
- insert the new diodes between the dissipator and the spring, taking care not to damage the component during assembly (the screw should be inserted under pressure on the dissipator so as to lock the component);
- place the dissipator with the new components in the PCB bump contacts and fasten them down with the screws (torque wrench setting for screws $1 \text{ Nm} \pm 20\%$);
- solder the terminals taking care not to let the solder run along them;
- on the soldering side cut away the protruding part of the rheofores and check they are not shorted (between cathode and anode);

N.B. make sure resistor (R31) and capacitor (C30) on the snubber have been soldered to the PCB correctly (fig. 3).

C) Please read the procedure for replacing the control board (fig. 3):

Whatever fault occurs in the control board, we strongly recommend its replacement without attempts at repair. To remove it, cut and then unsolder from the power board the connector keeping it fixed perpendicular to the PCB, replace it and re-solder the connector.

TESTING THE MACHINE

Tests should be carried out on the assembled machine before closing it with the top cover. During tests with the machine in operation never commute the selectors or activate the ohmic load contactor.

WARNING! Before proceeding to test the machine, we should remind you that during these tests the power source is powered and therefore the operator is exposed to the danger of electric shock.

The tests given below are used to verify power source operation under load.

1.1 Preparation for testing.

A) Connect the power source to the static load generator using cables fitted with the appropriate dinse connectors (code 802110).

B) Set up the dual trace oscilloscope, connecting probe CH1 (x100) to the collector on Q1 and probe CH2 (x10) to pin 9 on strip J6 (plasma control board). The earth terminals are connected together to the emitter of Q1.

C) Set up the multimeter in DC mode and connect the prods to the OUT+ and OUT- bump contacts.

D) Connect the power supply cable to the 230Vac power supply.

WARNING! During tests the operator must avoid contact with the metal parts of the torch because of the presence of dangerous, high voltage.

1.2 Tests for the TECNICA 141

A) Intermediate load test:

- set up the static load generator with the switch settings as in the table in **fig. D**;
- on the front panel position the current potentiometer R7 about half range and switch on the main switch;
- activate the static load generator and make sure that:
 - the waveforms displayed on the oscilloscope resemble those in **Fig. D**;
 - the output current is $+60 \text{ Adc} \pm 10\%$, and the output voltage is $+22.4 \text{ Vdc} \pm 10\%$
- deactivate the static load generator and switch off the main switch.

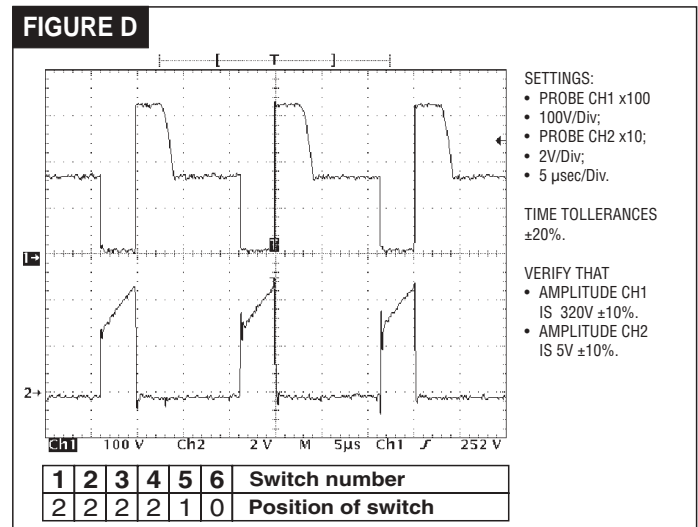

B) Rated load test:

- set up the static load generator with the switch settings as in the table in **fig. E**;
- on the front panel position the current potentiometer R7 to the maximum (turn the knob clockwise as far as it will go) and switch on the main switch;
- activate the static load generator and make sure that:
 - the voltage waveforms on the oscilloscope display resemble those in **fig. E**;
 - the output current is $+120 \text{ Adc} \pm 5\%$, and the output voltage is $+24.8 \text{ Vdc} \pm 5\%$.
- deactivate the static load generator and switch off the main switch.

FIGURE E

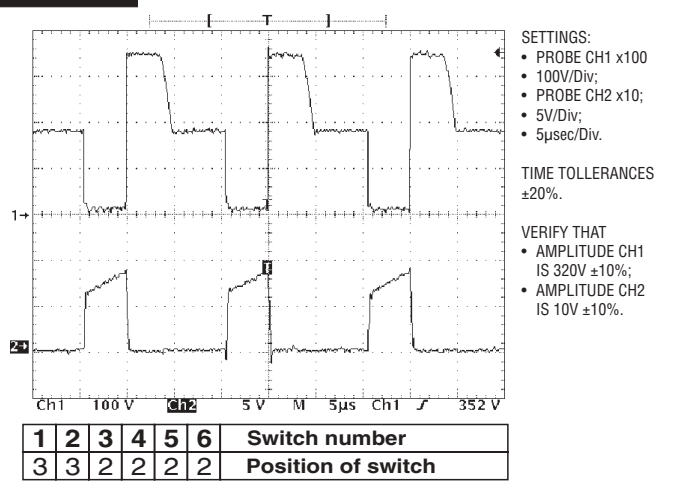

C) Checking the secondary diode voltages:

- set up the dual trace oscilloscope, connecting probe CH1 x 100 to the anode of diode D21 and probe CH2x100 to the anode of diode D22. Earth connections are both made to the secondary dissipator;
- remove the multimeter from the OUT+ and OUT- bump contacts;
- set up the static load generator with the switch settings as in the table in **fig. E**;
- on the front panel position the current potentiometer R7 to the maximum (turn the knob clockwise as far as it will go) and switch on the main switch;
- activate the static load generator and make sure that the waveforms displayed on the oscilloscope resemble those in **fig. F**;
- deactivate the static load generator and switch off the main switch.

FIGURE F

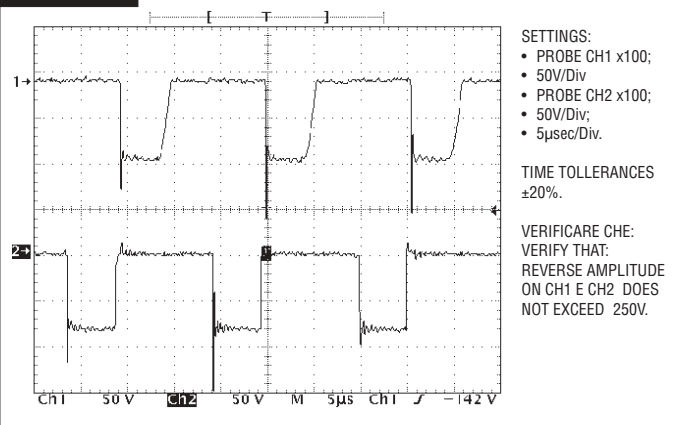

D) Running time check and closing the machine

With the load status as in **fig. E** and the current adjustment potentiometer (R7) on maximum, switch on the power source and leave it in operation until the thermostatic capsules trigger (machine in alarm status). Check the correct positioning of the internal wiring and finally re-assemble the machine.

E) Welding test

With the power source set up according to the instructions in the handbook make a test weld at 80A (electrode diameter 2.5 mm). Check the dynamic behaviour of the power source.

1.3 Tests for the TECNICA 141

In this case the tests are exactly the same as for the Tecnica 141 and can be carried out in the same way with the exception of the following points in section 1.2:

- replace **point B)** with **point A)** in section 1.3);
- in **points C)** and **D)** replace the load in **fig. E** with the load given in **fig. G** in section 1.3.

A) Rated load test:

- set up the static load generator with the switch settings as in the table in **fig. G**;
- on the front panel position the current potentiometer R7 to the maximum (turn the knob clockwise as far as it will go) and switch on the main switch;
- activate the static load generator and make sure that:
 - the voltage waveforms on the oscilloscope display resemble those in **fig. G**;
 - the output current is +150Adc±5%, and the output voltage is +26Vdc±5%.
- deactivate the static load generator and switch off the main switch.

FIGURE G

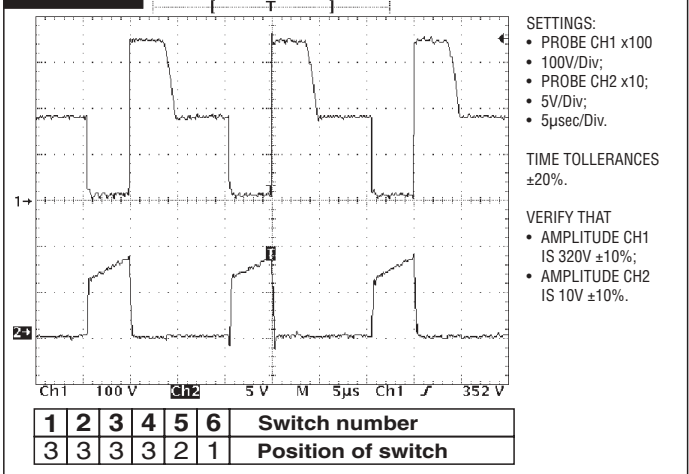

B) Running time check and closing the machine

With the load status as in **fig. G** and the cutting current adjustment potentiometer (R42) on maximum, switch on the power source and leave it in operation until the thermostatic capsules trigger (machine in alarm status). Check the correct positioning of the internal wiring and finally re-assemble the machine.

ILLUSTRATIONS

FIG. 1

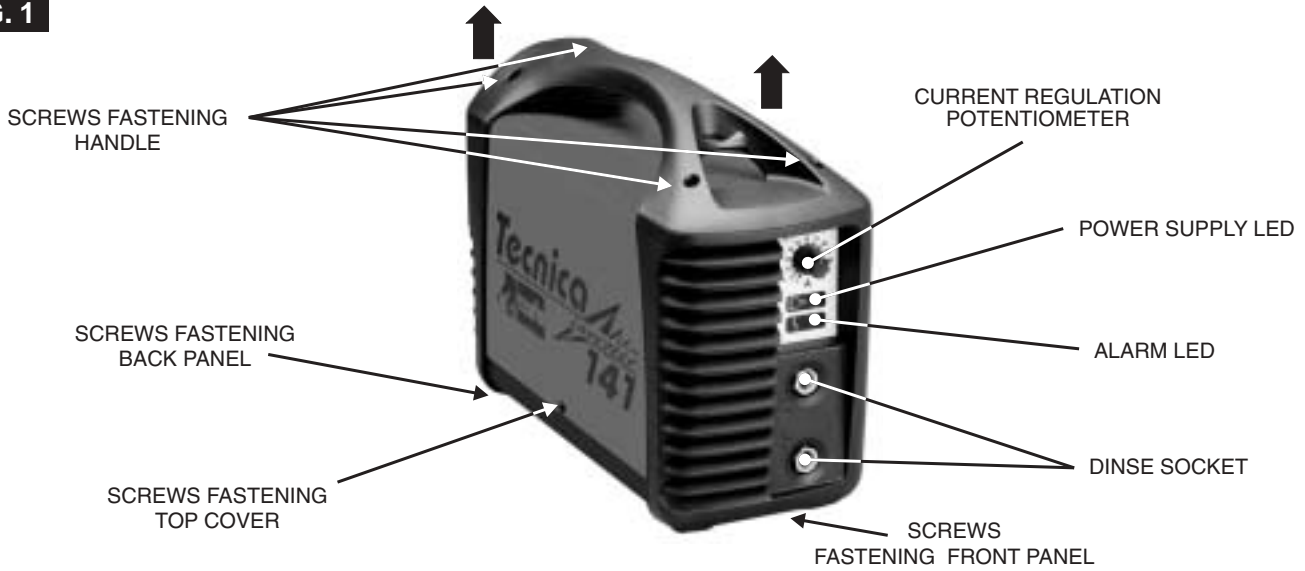

FIG. 2A

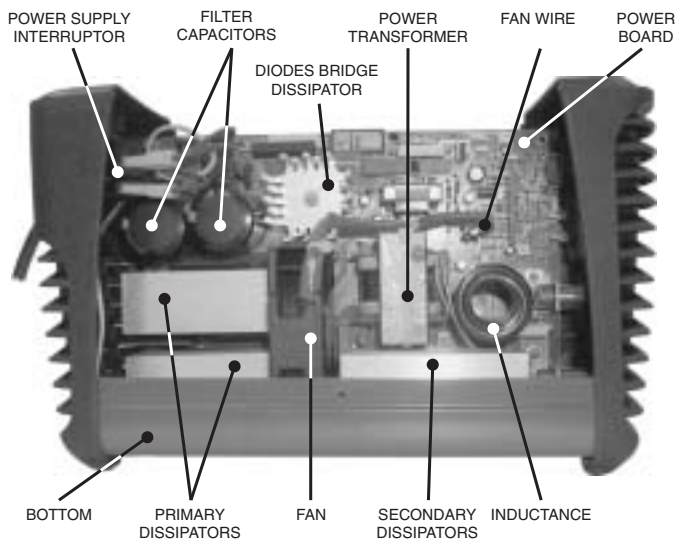

FIG. 2B

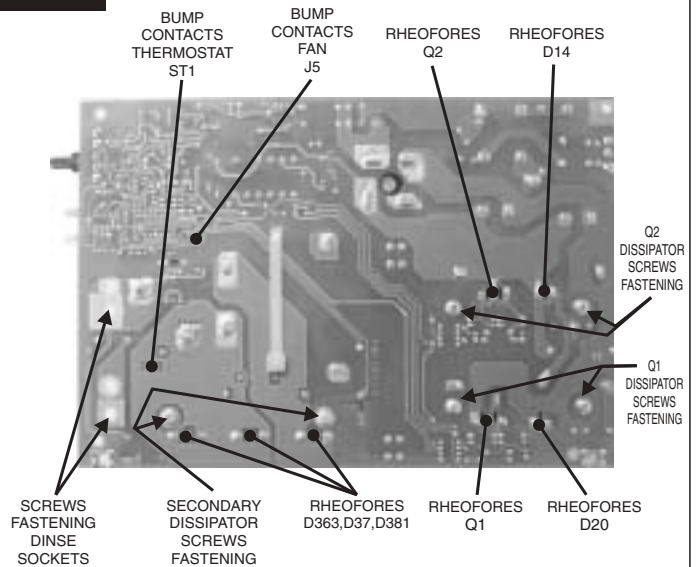

FIG. 3

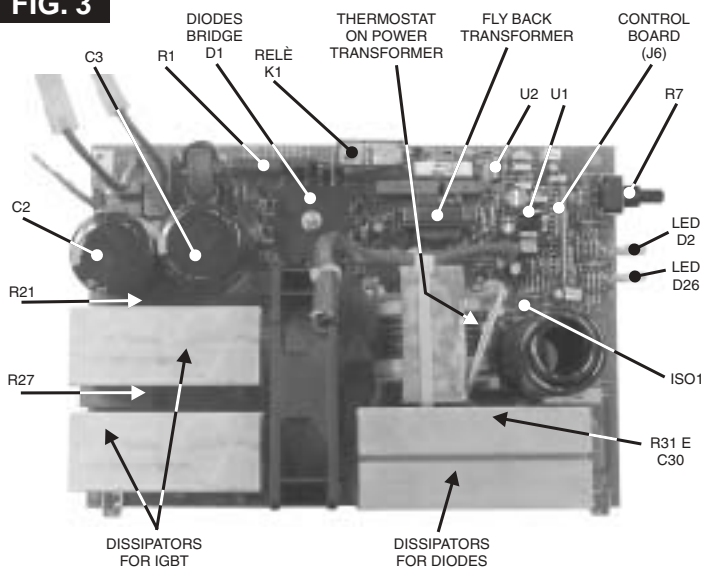
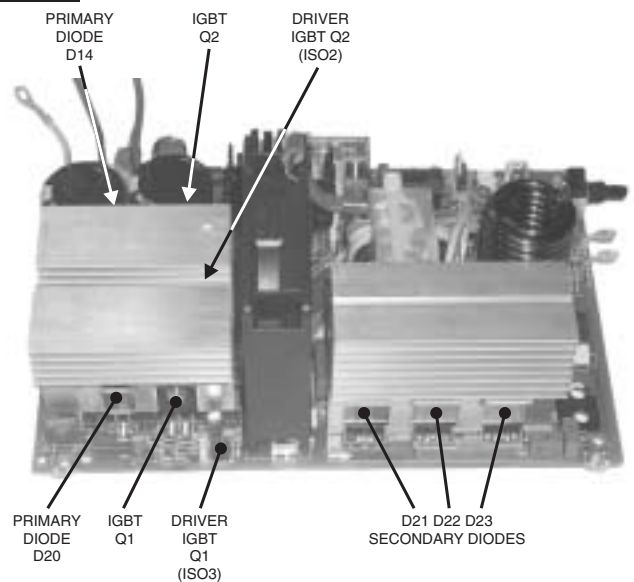
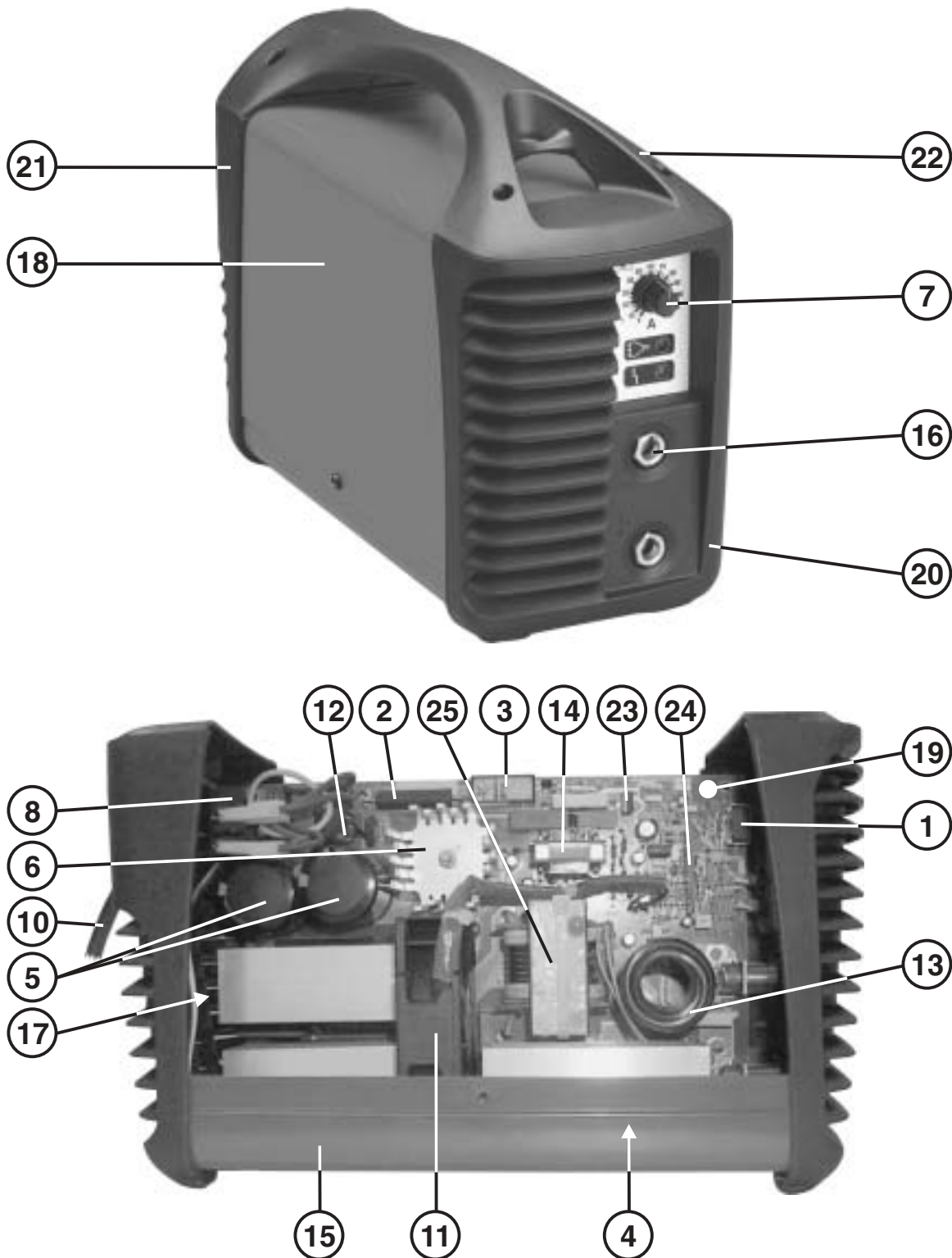

FIG. 4



ELENCO PEZZI DI RICAMBIO - LISTE PIECES DETACHEES SPARE PARTS LIST - ERSATZTEILLISTE - PIEZAS DE REPUESTO

Esplso macchina, Dessin appareil, Machine drawing, Explosions Zeichnung des Geräts, Diseño seccionado maquina.



Per richiedere i pezzi di ricambio senza codice precisare: codice del modello; il numero di matricola; numero di riferimento del particolare sull'elenco ricambi.
 Pour avoir les pieces detachees, dont manque la reference, il faudra preciser: modele, logo et tension de l'appareil; denomination de la piece; numero de matricule
 When requesting spare parts without any reference, pls specify: model-brand and voltage of machine; list reference number of the item; registration number
 Wenn Sie einen Ersatzteil, der ohne Artikel Nummer ist, benoetigen, bestimmen Sie bitte Folgendes: Modell-zeichen und Spannung des Geraetes; Teilliste Nuemmer; Registriernummer
 Por pedir una pieza de repuesto sin referencia precisar: modelo-marca e tension de la maquina; numero de riferimento de lista; numero de matricula

REF.	ELENCO PEZZI DI RICAMBIO PIECES DETACHEES SPARE PARTS LIST ERSATZTEILLISTE PIEZAS DE REPUESTO	REF.	ELENCO PEZZI DI RICAMBIO PIECES DETACHEES SPARE PARTS LIST ERSATZTEILLISTE PIEZAS DE REPUESTO	REF.	ELENCO PEZZI DI RICAMBIO PIECES DETACHEES SPARE PARTS LIST ERSATZTEILLISTE PIEZAS DE REPUESTO	REF.	ELENCO PEZZI DI RICAMBIO PIECES DETACHEES SPARE PARTS LIST ERSATZTEILLISTE PIEZAS DE REPUESTO
1	Potenziometro Potentiometre Potentiometer Potentiometer Potenciometro	10	Cavo Alim. Cable Alim. Mains Cable Netzkabel Cable Alim.	18	Kit Mantello Kit Capot Cover Kit Deckel Kit Kit Panel De Cobertura		
2	Resistenza Resistance Resistor Widerstand Resistencia	11	Ventilatore Ventilateur Fan Ventilator Ventilador	19	Kit Scheda Completa Kit Platine Complete Kit Complete Pcb Kit Komplette Steuerungskarte Kit Tarjeta Completa		
3	Rele' Relais Relais Relais Relais	12	Induttanza Filtro Inductance Filter Filter Inductance Filter Drossel Induccion Filtro	20	Frontale Partie Frontal Front Panel Geratetfront Frontal		
4	Diode Diode Diode Diode Diode	13	Induttanza Inductance Inductance Drossel Induccion	21	Retro Partie Arriere Back Panel Rueckseite Trasera		
5	Condensatore Condensateur Capacitor Kondensator Condensador	14	Trasformatore Flyback Transformateur Flyback Flyback Transformer Flyback Transformator Transformador Flyback	22	Maniglia Poignee Handle Handgriff Manija		
6	Raddrizzatore Redresseur Rectifier Gleichrichter Rectificador	15	Fondo Chassis Bottom Bodenteil Fondo	23	Pwm Controller Pwm Controller Pwm Controller Pwm Controller Pwm Controller		
7	Manopola Potenziometro Poignee Pour Potentiometre Knob For Potentiometer Potentiometergriff Malja Por Resist.electr.variable	16	Presa Dinse Prise Dix Dinse Socket Dinse Steckdose Enchufe Dinse	24	Scheda Controllo Platine De Control Control Pcb Steuerungskarte Tarjeta De Controllo		
8	Interruttore Interrupteur Switch Schalter Interruptor	17	Kit IGBT + Diode Kit IGBT + Diode Kit IGBT + Diode Kit IGBT + Diode Kit IGBT + Diode	25	Trasformatore potenza Transformateur Puissance Power Transformer Leistungstransformator Transformador De Potencia		

TECHNICAL REPAIR CARD.

In order to improve the service, each servicing centre is requested to fill in the technical card on the following page at the end of every repair job. Please fill in this sheet as accurately as possible and send it to Telwin. Thank you in advance for your co-operation!



Official servicing centers Repairing sheet

Date: _____

Inverter model: _____

Serial number: _____

Company: _____

Technician: _____

In which place has the inverter been used?

- Building yard
- Workshop
- Others: _____

Supply:

- Power supply
- From mains without extension
- From mains with extension m: _____

Mechanical stresses the machine has undergone to

Description: _____

Dirty grade

Dirty inside the machine

Description: _____

Kind of failure	Component ref.	
Rectifier bridge.....		<p>Substitution of primary power board: yes <input type="checkbox"/> no <input type="checkbox"/></p> <p>Troubles evinced during repair :</p> <p>_____</p> <p>_____</p> <p>_____</p> <p>_____</p> <p>_____</p>
Electrolytic capacitors		
Relais.....		
In-rush limiter resistance		
IGBT.....		
Snubber.....		
Secondary diodes.....		
Potentiometer.....		
Others.....		



TELWIN S.p.A. - Via della Tecnica, 3
36030 VILLAVERLA (Vicenza) Italy
Tel. +39 - 0445 - 858811
Fax +39 - 0445 - 858800 / 858801
E-mail: telwin@telwin.com <http://www.telwin.com>



CERTIFIED QUALITY SYSTEM
UNI EN ISO 9001:2000

