

Silicon PIN Diodes

BAR 14-1
... BAR 16-1

- RF switch
- RF attenuator for frequencies above 10 MHz
- Low distortion factor
- Long-term stability of electrical characteristics

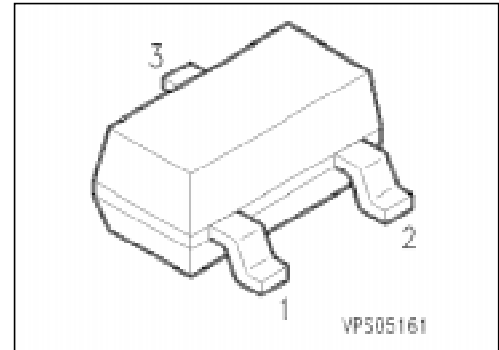
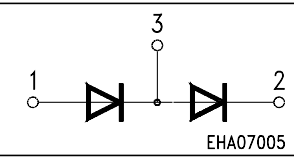
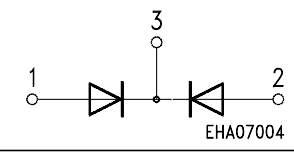
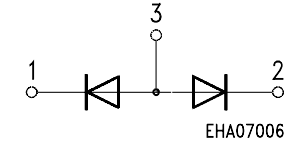

Type	Marking	Ordering Code (tape and reel)	Pin Configuration	Package ¹⁾
BAR 14-1	L7	Q62702-A772		SOT-23
BAR 15-1	L8	Q62702-A731		
BAR 16-1	L9	Q62702-A773		

Maximum Ratings per Diode

Parameter	Symbol	Values	Unit
Reverse voltage	V_R	100	V
Forward current	I_F	140	mA
Total power dissipation, $T_s \leq 65^\circ\text{C}^2)$	P_{tot}	250	mW
Junction temperature	T_j	150	°C
Storage temperature range	T_{stg}	- 55 ... + 150	
Operating temperature range	T_{op}	- 55 ... + 150	

Thermal Resistance

Junction - ambient ²⁾	$R_{th\ JA}$	≤ 500	K/W
Junction - soldering point	$R_{th\ JS}$	≤ 340	

¹⁾ For detailed information see chapter Package Outlines.

²⁾ Package mounted on alumina 15 mm × 16.7 mm × 0.7 mm.

Electrical Characteristics per Diode
at $T_A = 25\text{ }^\circ\text{C}$, unless otherwise specified.

Parameter	Symbol	Values			Unit
		min.	typ.	max.	
Reverse current $V_R = 50\text{ V}$ $V_R = 100\text{ V}$	I_R	– –	– –	100 1	nA μA
Forward voltage $I_F = 100\text{ mA}$	V_F	–	1.05		V
Diode capacitance $V_R = 50\text{ V}, f = 1\text{ MHz}$ $V_R = 0, f = 100\text{ MHz}$	C_T	– –	0.25 0.2	0.5 –	pF
Forward resistance $f = 100\text{ MHz}, I_F = 0.01\text{ mA}$ $I_F = 0.10\text{ mA}$ $I_F = 1\text{ mA}$ $I_F = 10\text{ mA}$	r_f	– – – –	2800 380 45 7	– – – –	Ω
Zero bias conductance $V_R = 0, f = 100\text{ MHz}$	g_p	–	50	–	μS
Charge carrier life time $I_F = 10\text{ mA}, I_R = 6\text{ mA}$	τ_L	0.7	1	–	μS

Forward current $I_F = f(V_F)$

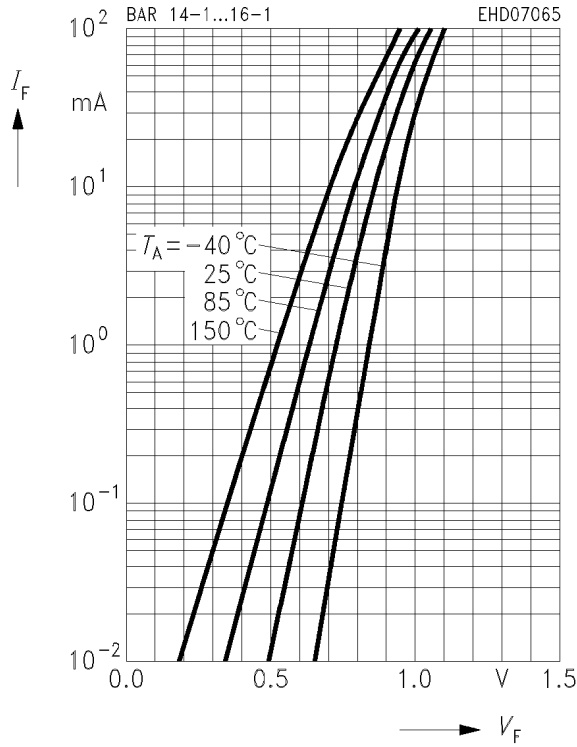

Forward current $I_F = f(T_S; T_A^*)$

*Package mounted on alumina

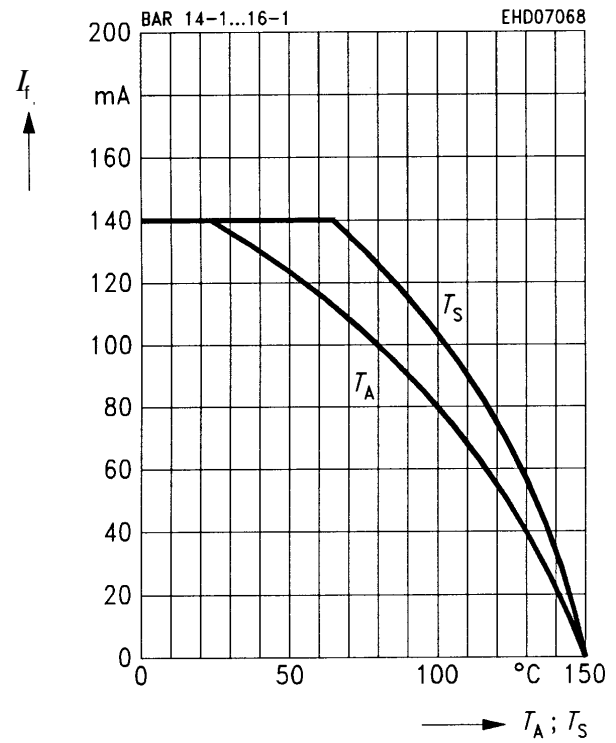

Forward resistance $r_f = f(I_F)$

$f = 100$ MHz

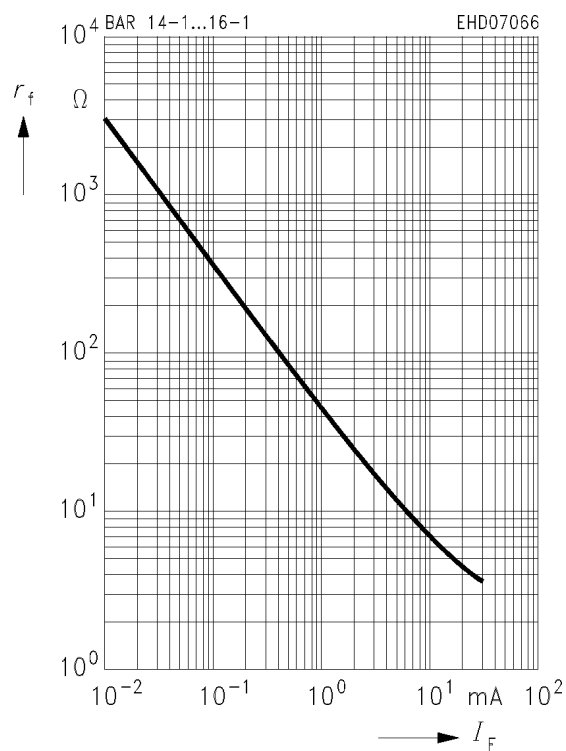

Diode capacitance $C_T = f(V_R)$

