

S55/S56/S57 (Bluetooth)

Level 2.5

Repair Documentation

V 1.0

Table of Content

1	Introduction	3
2	I/O Connector (Slim Lumberg)	4
3	Battery Connector	8
4	Display Connector	11
5	Antenna Connector	14
6	Card Reader	18
7	Board Connector	21
8	IRDA	25
9	Bluetooth antenna	28

1 Introduction

S55 product family, consists of 2 tripleband (GSM900, GSM1800 and GSM1900) handsets named S55 and S57, which can be distinguished from the second block after the partnumber printed on the IMEI label, and the S56, a dualband mobilphone (GSM850 and GSM1900)

Partnumber on IMEI label:

S55: S30880-S5720-#xxx

S56: S30880-S5350-#xxx

S57: S30880-S5700-#xxx

, while # may be any letter (A-Z) and xxx may be any number from 100, 101, 102....

This manual is intended to help you carry out repairs on level 2.5, meaning limited component repairs. The documented failure highlights should be repaired in the local workshops.

All repairs have to be carried out in an environment set up according to the ESD (Electrostatic Discharge Sensitive Devices) regulations defined in international standards.

If you have any questions regarding the repair procedures or technical questions about the spare parts do not hesitate to contact our technical support team in Kamp-Lintfort, Germany:

Tel.: +49 2842 95 4666

Fax: +49 2842 95 4302

e-mail: st-support@klf.siemens.de

2 I/O Connector (Slim Lumberg)

2.1 Affected Units

2.1.1 Type: S55/S56/S57

2.1.2 Affected IMEIs / Date Codes: All / All

2.1.3 Affected SW Versions: All

2.2 Fault Description

2.2.1 Fault Symptoms for customers:

- Charging problems.
- Problems with external loudspeaker or microphone when using a car kit.
- Problems with accessories connected at the I/O - connector.
- Problems with SW booting

2.2.2 Fault Symptoms on GSM Tester:

This fault cannot be detected with a GSM-Tester

2.3 Priority:

- | | |
|-------------------------------------|-----------------|
| <input type="checkbox"/> | Mandatory |
| <input checked="" type="checkbox"/> | Repair |
| <input type="checkbox"/> | Optional |
| <input type="checkbox"/> | Not Yet Defined |

2.4 Repair Documentation:

2.4.1 Description of procedure:

2.4.1.1 Diagnosis:

Visually check the bottom connector. Watch for dry joints:

2.4.1.2 Repair by component change:

Use hot air blower remove defective I/O connector.
Avoid excessive heat!
Watch surrounding components!

Resolder new I/O connector afterwards.

2.4.1.3 Repair by Software booting:

Not possible!

2.4.1.4 Test:

Retest handset after repair.

2.4.2 List of needed material:

2.4.2.1 Components:

I/O Connector S55/S56/S57
Part-Number: L36334-Z93-C303

2.4.2.2 Jigs and Tools:

Hot Air Blower
Soldering Iron

2.4.2.3 Special tools:

None

2.4.2.4 Working materials

Desolder Wick / Braid
Solder

2.4.3 Drawings

Figure 1: S55/S56/S57 board I/O connector

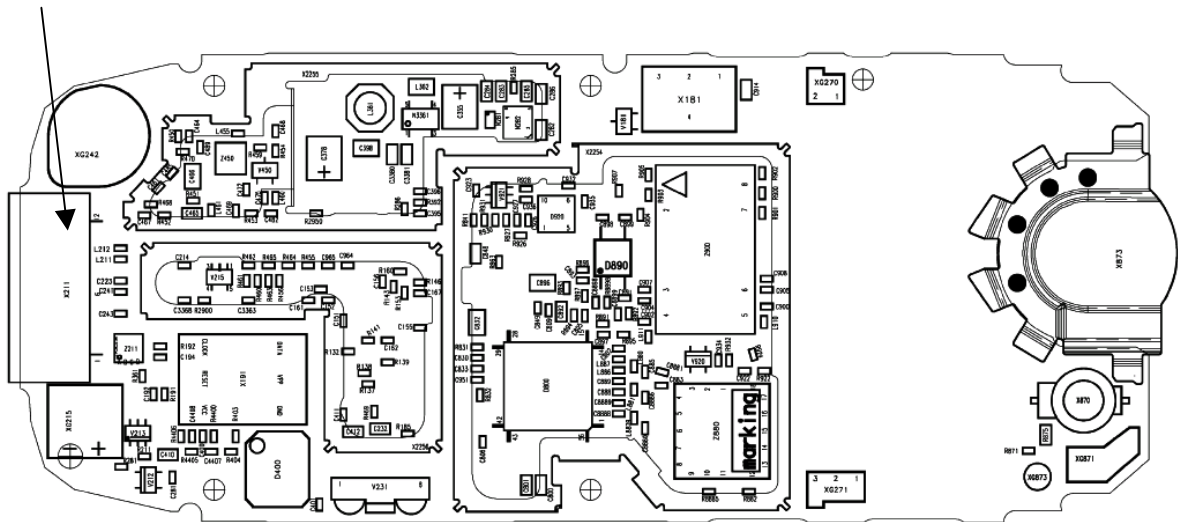

Figure 2: S55/S56/S57 I/O connector placement (top view)

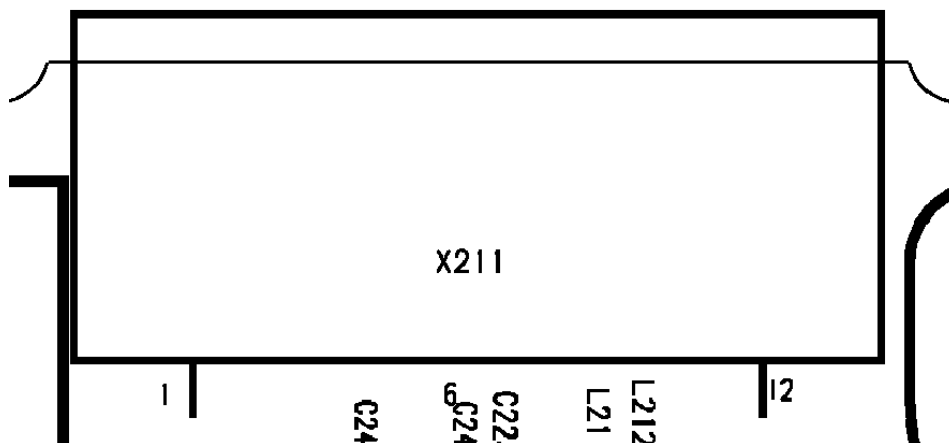

Table 1: S55/S56/S57 Bottom Connector Pin Description

Pin	Name	IN/OUT	Notes
1	POWER	I/O	POWER is needed for charging batteries and for supplying the accessories
2	GND		
3	TX_1	O	Serial interface
4	RX_1	I	Serial interface
5	CTS_1	I/O	Data line for accessory bus
6	RTS_1	I/O	Use as RTS in data operation
7	DCD_1	I/O	Clock line for accessory bus Use as DTC In data operation
8	AUDIO_P	O	External loudspeaker
9			
10	AUDIO_N	OI	External loudspeaker
11	GND_MIC	I	External microphone
12	EPP1	O	External microphone

3 Battery Connector

3.1 Affected Units

3.1.1 Type: S55/S56/S57

3.1.2 Affected IMEIs / Date Codes: All / All

3.1.3 Affected SW Versions: All

3.2 Fault Description

3.2.1 Fault Symptoms for customers:

Mobile does not switch on.
Error message "WRONG BATTERY" on display.

3.2.2 Fault Symptoms on GSM Tester:

This fault cannot be detected with a GSM-Tester.

3.3 Priority:

- Mandatory
- Repair
- Optional
- Not Yet Defined

3.4 Repair Documentation:

3.4.1 Description of procedure:

3.4.1.1 Diagnosis:

Visually check the status of the Battery connector. Watch for oxidation and dry solder joints.

3.4.1.2 Repair by component change:

Use hot air blower remove defective Battery connector.

Avoid excessive heat!

Watch surrounding components!

Resolder new Battery connector afterwards.

3.4.1.3 Repair by Software booting:

Not possible!

3.4.1.4 Test:

Retest handset after repair.

3.4.2 List of needed material:

3.4.2.1 Components:

Battery Connector S55/S56/S57

Part-Number: L36334-Z97-C160

3.4.2.2 Jigs and Tools:

Hot Air Blower

Soldering Iron

3.4.2.3 Special tools:

None

3.4.2.4 Working materials

Desolder Wick / Braid
Soldering Iron

3.4.3 Drawings

Figure 1: S55/S56/S57 board Battery connector

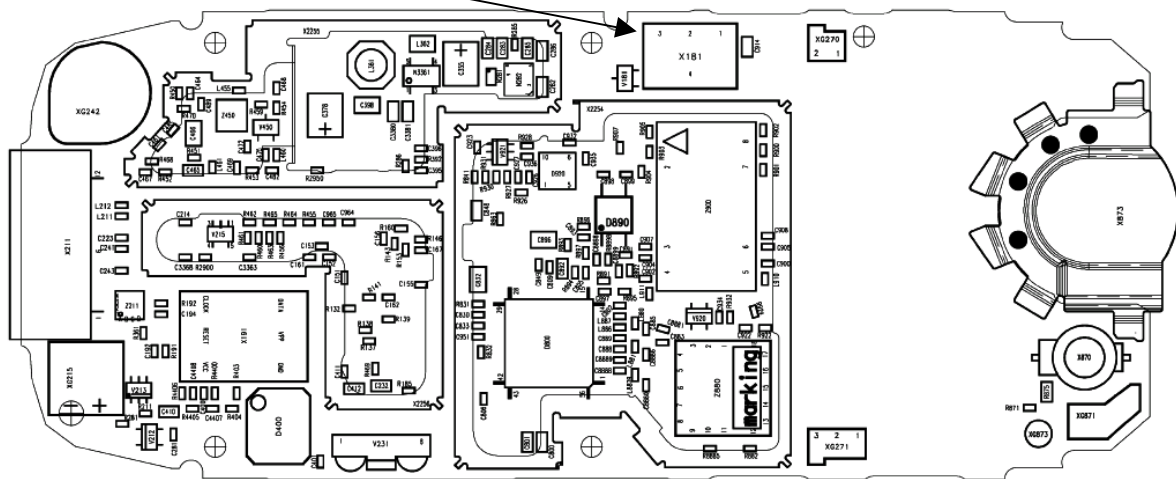
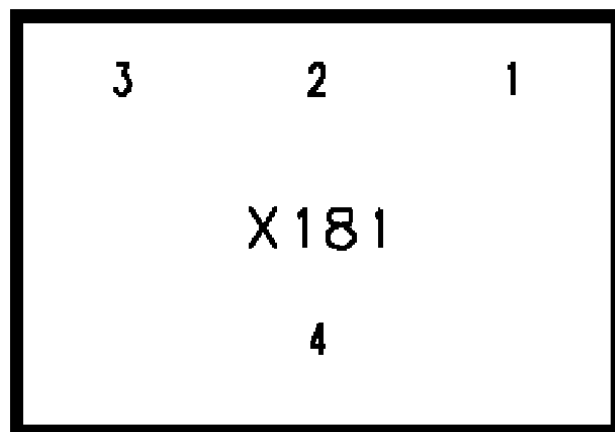

Figure 2: S55/S56/S57 Battery connector placement (top view)



4 Display Connector

4.1 Affected Units

4.1.1 Type: S55/S56/S57

4.1.2 Affected IMEIs / Date Codes: All / All

4.1.3 Affected SW Versions: All

4.2 Fault Description

4.2.1 Fault Symptoms for customers:

Display problems, like missing lines or columns on the LCD or display contrast problems.

4.2.2 Fault Symptoms on GSM Tester:

Display tests failed.

4.3 Priority:

- Mandatory
- Repair
- Optional
- Not Yet Defined

4.4 Repair Documentation:

4.4.1 Description of procedure:

4.4.1.1 Diagnosis:

Visually check the status of the Display connector. Watch for oxidation

4.4.1.2 Repair by component change:

Use hot air blower remove defective Display connector.
Avoid excessive heat!
Watch surrounding components!

Resolder new Display connector afterwards.

4.4.1.3 Repair by Software booting:

Not possible!

4.4.1.4 Test:

Retest handset after repair.

4.4.2 List of needed material:

4.4.2.1 Components:

Display Connector S55/S56/S57
Part-Number: L36334-Z97-C205

4.4.2.2 Jigs and Tools:

Hot Air Blower
Soldering Iron

4.4.2.3 Special tools:

None

4.4.2.4 Working materials

Desolder Wick / Braid
Soldering Iron

4.4.3 Drawings

Figure 1: S55/S56/S57 board Display connector

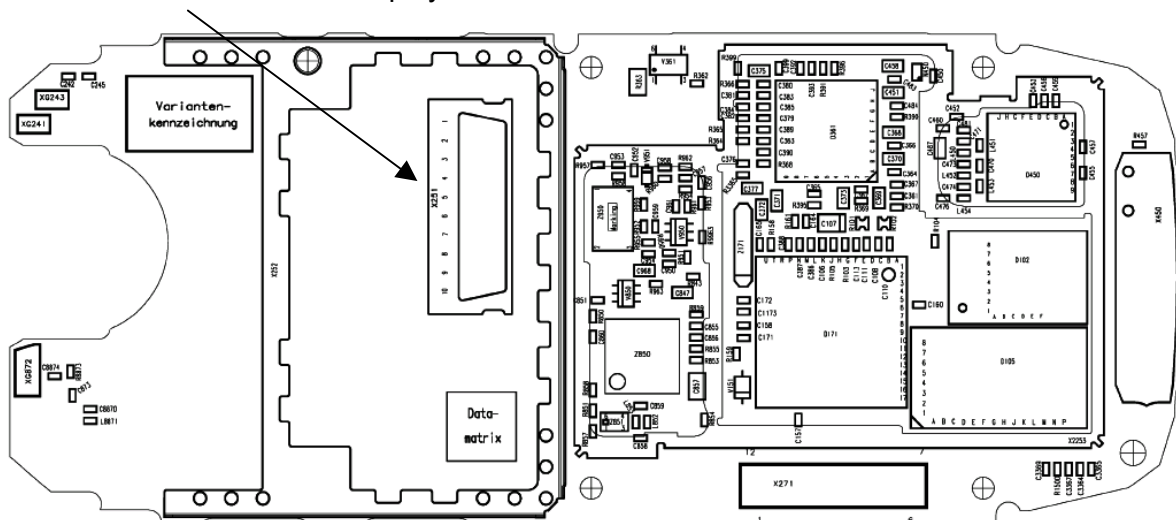
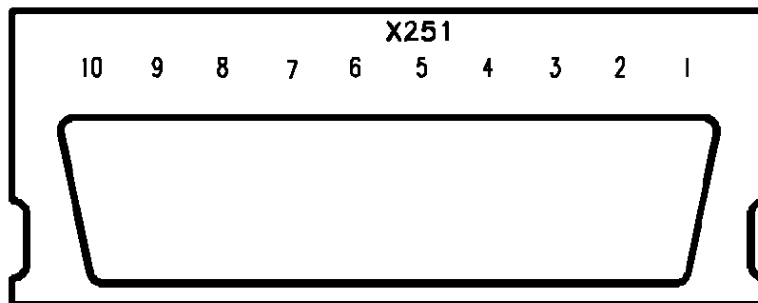

Figure 2: S55/S56/S57 Display connector placement (top view)



5 Antenna Connector

5.1 Affected Units

5.1.1 Type: S55/S56/S57

5.1.2 Affected IMEIs / Date Codes: All / All

5.1.3 Affected SW Versions: All

5.2 Fault Description

5.2.1 Fault Symptoms for customers:

Network Search
No location update possible

5.2.2 Fault Symptoms on GSM Tester:

Output power problems on the external and internal antenna
No location update possible

5.2.3 Component Information:

The Antenna Connector is a mechanical switch operated by the RF plug of a car kit. Normally the RF signal goes to and comes from the internal antenna. Whenever an RF plug is plugged into the antenna connector the connection to the internal antenna is opened and the connection to the external antenna socket is made. When the antenna connector is blocked without RF plug the connection to the internal antenna is also opened. See drawing below.

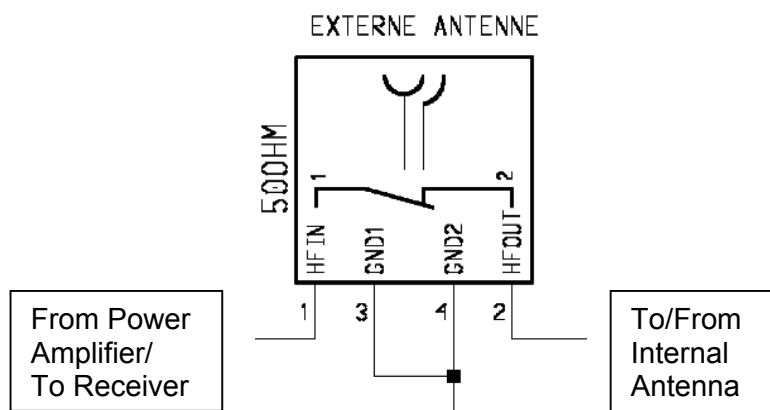

5.3 Priority:

- Mandatory
- Repair
- Optional
- Not Yet Defined

5.4 Repair Documentation:**5.4.1 Description of procedure:****5.4.1.1 Diagnosis:**

Check the output power of the handset with the LSO test program. Especially watch the external antenna power!

5.4.1.2 Repair by component change:

Use hot air to remove defective antenna connector.
Avoid excessive heat!
Watch surrounding components!!

Resolder new module afterwards

5.4.1.3 Repair by Software booting:

Not possible!

5.4.1.4 Test:

Retest handset after repair.

5.4.2 List of needed material:**5.4.2.1 Components:**

Antenna Connector S55/S56/S57
Part-Number: L36334-Z93-C272

5.4.2.2 Jigs and Tools:

Hot Air Blower
Soldering Iron

5.4.2.3 Special tools:

None

5.4.2.4 Working materials

Desolder Wick / Braid
Soldering Iron

5.4.3 Drawings

Figure 1: S55/S56/S57 board Antenna connector

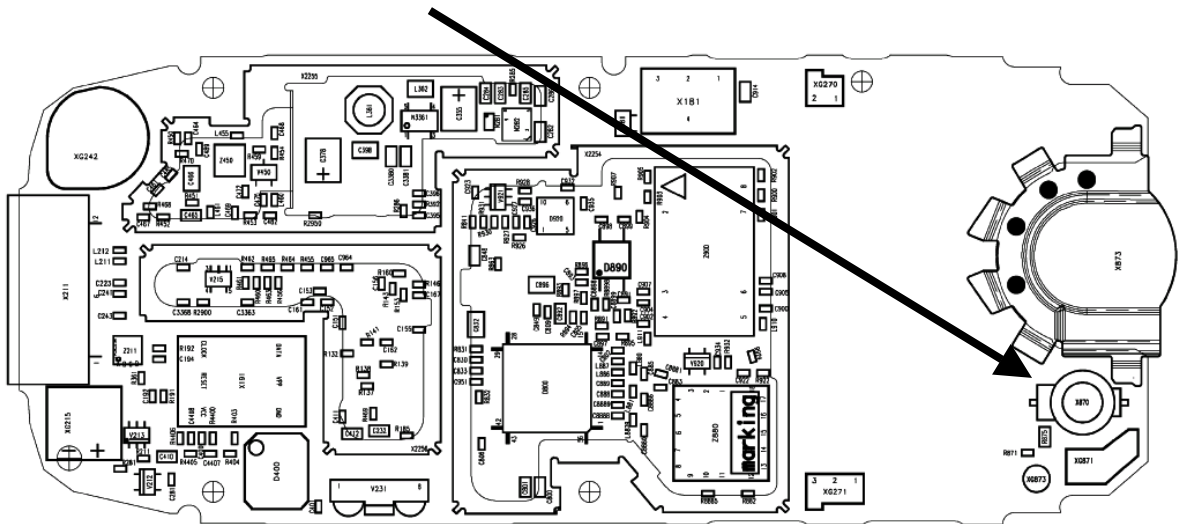
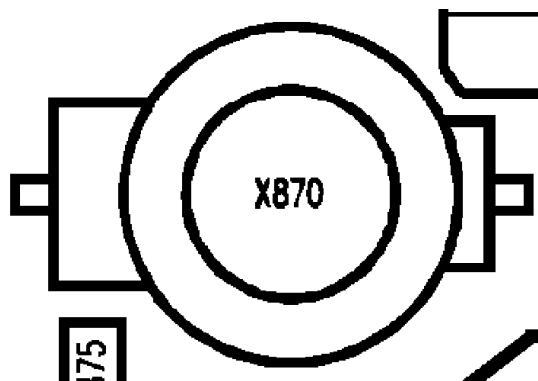

Figure 2: S55/S56/S57 Antenna connector placement (top view)



6 Card Reader

6.1 Affected Units

6.1.1 Type: S55/S56/S57

6.1.2 Affected IMEIs / Date Codes: All / All

6.1.3 Affected SW Versions: All

6.2 Fault Description

6.2.1 Fault Symptoms for customers:

Handset does not accept SIM.

6.2.2 Fault Symptoms on GSM Tester:

This fault cannot be detected with a GSM-Tester

6.3 Priority:

- Mandatory
- Repair
- Optional
- Not Yet Defined

6.4 Repair Documentation:

6.4.1 Description of procedure:

6.4.1.1 Diagnosis:

Visually check the Card Reader. Watch for dry joints:

6.4.1.2 Repair by component change:

Use soldering iron to remove defective component.
Avoid excessive heat!
Watch surrounding components!

Resolder new Card Reader afterwards.

6.4.1.3 Repair by Software booting:

Not possible!

6.4.1.4 Test:

Retest handset after repair.

6.4.2 List of needed material:

6.4.2.1 Components:

Card Reader S55/S56/S57
Part-Number: L36334-Z93-C204

6.4.2.2 Jigs and Tools:

Hot Air Blower
Soldering Iron

6.4.2.3 Special tools:

None

6.4.2.4 Working materials

Desolder Wick / Braid
Soldering Iron

6.4.3 Drawings

Figure 1: S55/S56/S57 board Card Reader site

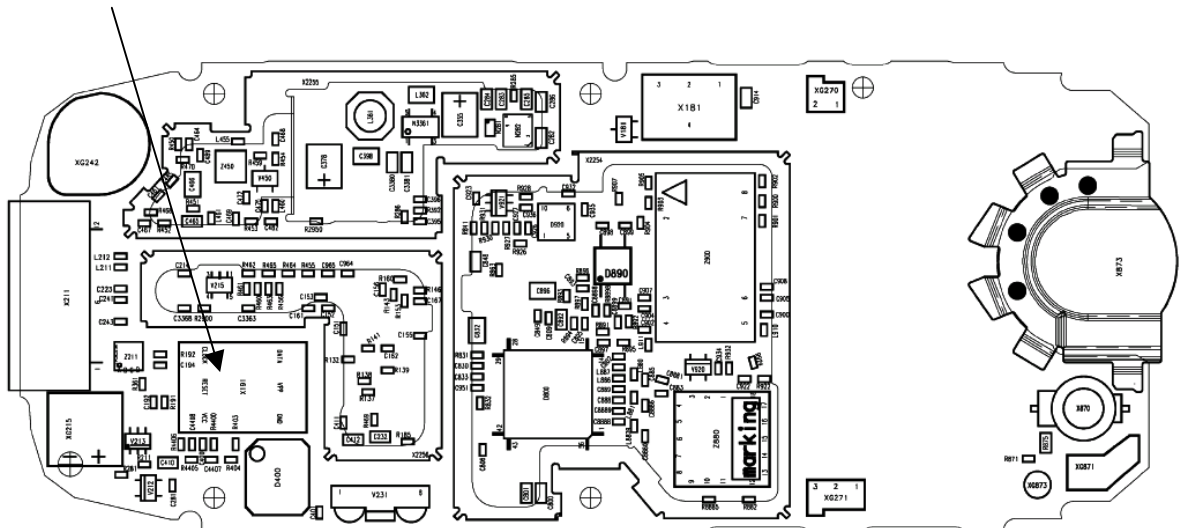
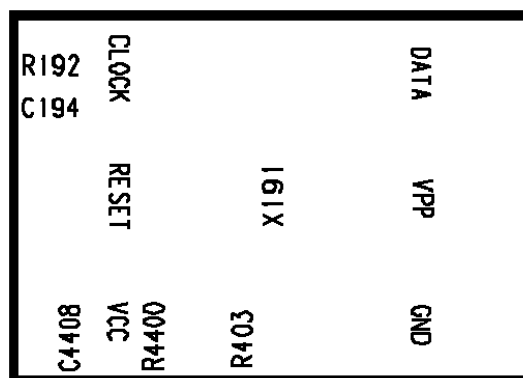

Figure 2: S55/S56/S57 Card Reader placement (top view)



7 Board Connector

7.1 Affected Units

7.1.1 Type: S55/S56/S57

7.1.2 Affected IMEIs / Date Codes: All / All

7.1.3 Affected SW Versions: All

7.2 Fault Description

7.2.1 Fault Symptoms for customers:

Problems with MMI function like:

Keyboard malfunction
Illumination problems

7.2.2 Fault Symptoms on GSM Tester:

This fault cannot be detected with a GSM Tester

7.3 Priority:

- Mandatory
- Repair
- Optional
- Not Yet Defined

7.4 Repair Documentation:

7.4.1 Description of procedure:

7.4.1.1 Diagnosis:

Visually check the status of the board connector. Watch for oxidation and dry solder joints.

7.4.1.2 Repair by component change:

Use soldering iron to remove defective diode.
Avoid excessive heat!
Watch surrounding components!!

Resolder new connector afterwards.

7.4.1.3 Repair by Software booting:

Not possible!

7.4.1.4 Test:

Retest handset after repair.

7.4.2 List of needed material:

7.4.2.1 Components:

Board connector S55/S56/S57
Part-Number: L36334-Z97-C162

7.4.2.2 Jigs and Tools:

Hot Air Blower
Soldering Iron

7.4.2.3 Special tools:

None

7.4.2.4 Working materials

Desolder Wick / Braid
Soldering Iron

7.4.3 Drawings

Figure 1: S55/S56/S57 board connector side

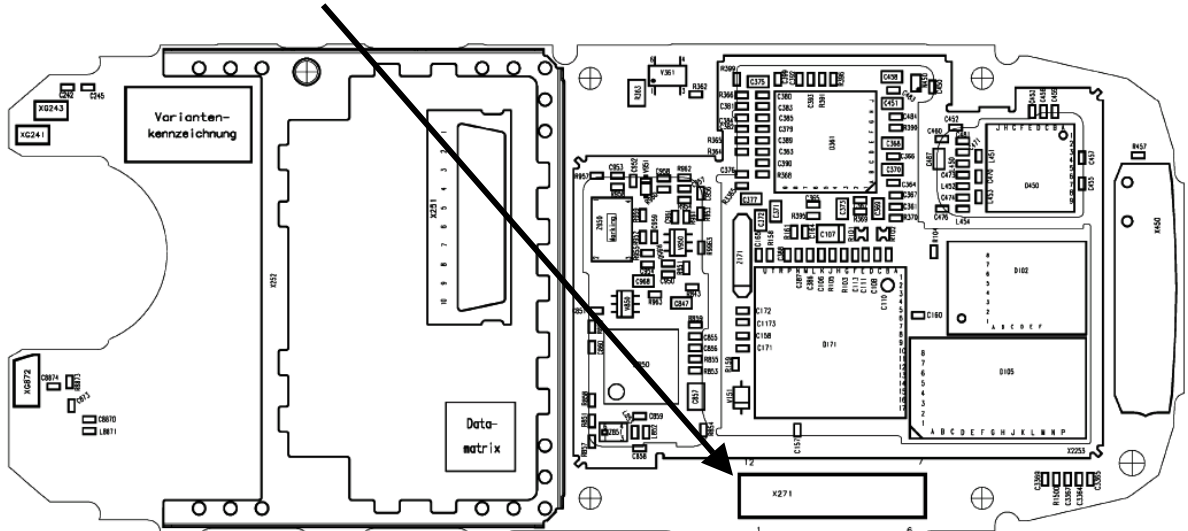

Figure 2: S55/S56/S57 board connector placement (top view)



8 IRDA

8.1 Affected Units

8.1.1 Type: S55/S56/S57

8.1.2 Affected IMEIs / Date Codes: All / All

8.1.3 Affected SW Versions: All

8.2 Fault Description

8.2.1 Fault Symptoms for customers:

No infrared connection possible

8.2.2 Fault Symptoms on GSM Tester:

This fault cannot be detected with a GSM Tester

8.3 Priority:

- Mandatory
- Repair
- Optional
- Not Yet Defined

8.4 Repair Documentation:

8.4.1 Description of procedure:

8.4.1.1 Diagnosis:

8.4.1.2 Repair by component change:

Use soldering iron to remove defective diode.
Avoid excessive heat!
Watch surrounding components!!

Resolder new connector afterwards.

8.4.1.3 Repair by Software booting:

Not possible!

8.4.1.4 Test:

Retest handset after repair.

8.4.2 List of needed material:

8.4.2.1 Components:

IRDA S55/S56/S57
Part-Number: L36810-U6030-D670

8.4.2.2 Jigs and Tools:

Hot Air Blower
Soldering Iron

8.4.2.3 Special tools:

None

8.4.2.4 Working materials

Desolder Wick / Braid
Soldering Iron

8.4.3 Drawings

Figure 1: S55/S56/S57 IRDA side

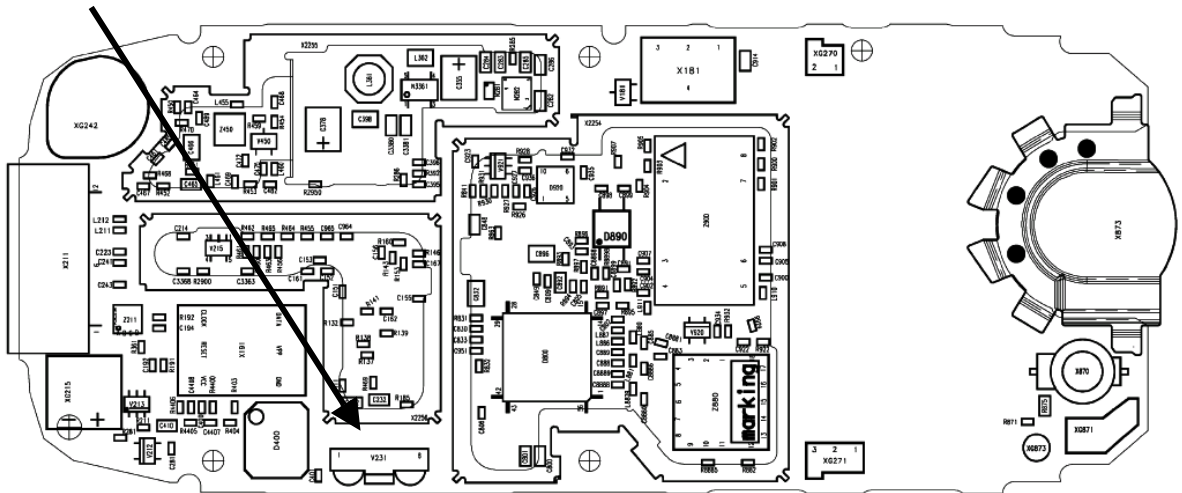
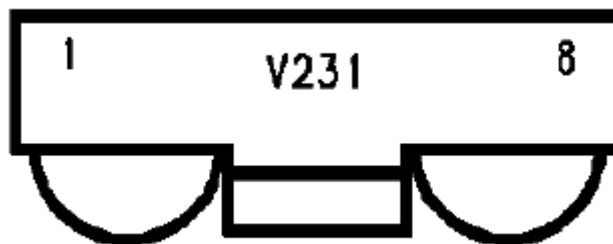

Figure 2: S55/S56/S57 IRDA placement (top view)



9 Bluetooth antenna

9.1 Affected Units

9.1.1 Type: S55/S56

9.1.2 Affected IMEIs / Date Codes: All / All

9.1.3 Affected SW Versions: All

9.2 Fault Description

9.2.1 Fault Symptoms for customers:

No Bluetooth connection possible

9.2.2 Fault Symptoms on GSM Tester:

This fault cannot be detected with a GSM Tester

9.3 Priority:

- Mandatory
- Repair
- Optional
- Not Yet Defined

9.4 Repair Documentation:

9.4.1 Description of procedure:

9.4.1.1 Diagnosis:

Check the output power of the handset with the Bluetooth tester. Watch the antenna power!

9.4.1.2 Repair by component change:

Use soldering iron to remove defective antenna.
Avoid excessive heat!
Watch surrounding components!!

Resolder new antenna afterwards.

9.4.1.3 Repair by Software booting:

Not possible!

9.4.1.4 Test:

Retest handset after repair.

9.4.2 List of needed material:

9.4.2.1 Components:

Bluetooth antenna S55 BLUETOOTH
Part-Number: L36851-Z1901-A49

9.4.2.2 Jigs and Tools:

Hot Air Blower
Soldering Iron

9.4.2.3 Special tools:

None

9.4.2.4 Working materials

Desolder Wick / Braid
Soldering Iron

9.4.3 Drawings

Figure 1: S55 BLUETOOTH Bluetooth antenna side

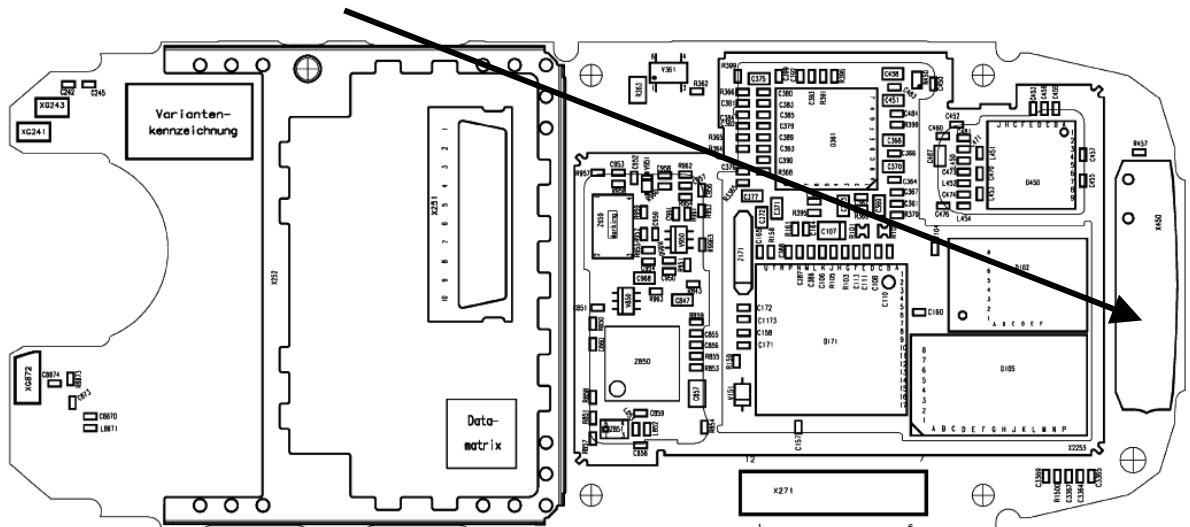

Figure 2: S55/S56/S57 Bluetooth antenna placement (top view)

