

By
Thomas
Scarborough

Poor Man's Metal Locator

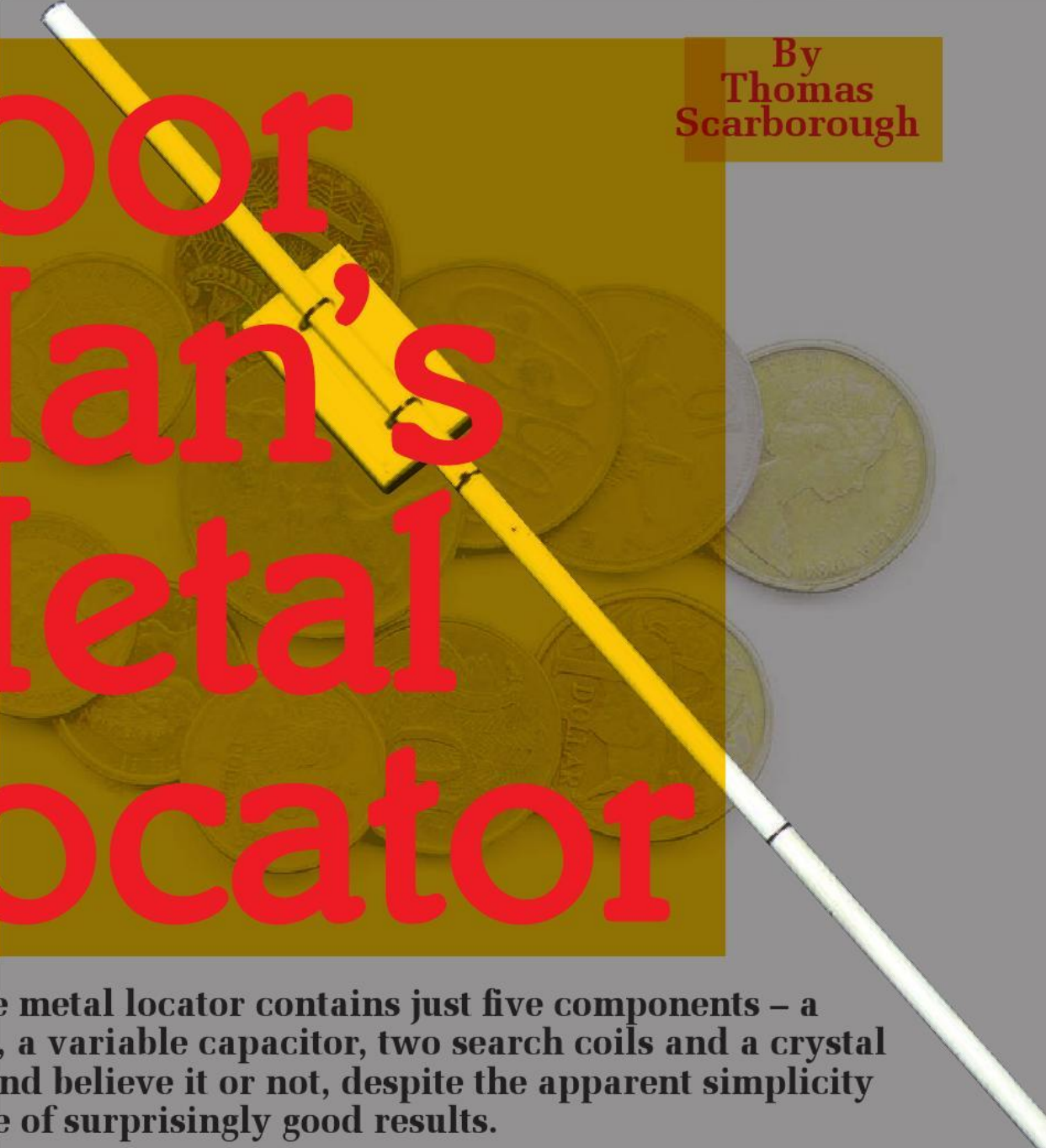

This unique metal locator contains just five components – a low-cost IC, a variable capacitor, two search coils and a crystal earpiece. And believe it or not, despite the apparent simplicity it is capable of surprisingly good results.

THIS CIRCUIT represents a genre of metal locator. Although it borrows from other kinds of locators/detectors, its basic principle of operation is different.

And while this may seem to stretch one's credulity, the performance matches that of a budget Induction Balance (IB) detector. Build it – and you will see! This design is even more simple than the original Beat Balance design published previously (*EPE* May 2004).

During testing, it detected an old English penny at 150mm (6") in air. However, I would only put my neck on the block for 125mm (5"), since a number of factors influence sensitivity.

This locator may therefore represent the writing on the wall for budget IB types and even puts paid to most of the advantages (the few remaining ones) of Beat Frequency Operation (BFO) detectors.

Overview

Instead of using a search and a reference oscillator (as in the BFO type), or transmit and receive coils (as in IB), this detector uses two transmitters (or search oscillators) with IB-style coil overlap.

As will be seen from Fig.1 and our photographs, these are extremely simple in design. Each oscillator comprises just one-quarter of a common

quad op amp IC plus the search coil!

The frequencies of the two oscillators are then mixed (in similar fashion to a BFO) to produce an audible heterodyne.

On the surface of it, this design would seem to represent little more than a twinned BFO metal locator. However, what makes it different above all else (and significantly increases its range) is that each coil modifies the frequency of the adjacent oscillator through inductive coupling. This introduces the "balance" that is present in an IB metal locator and boosts sensitivity well beyond that of a BFO.

Beyond this, all that is required is a means to control the mixer output

frequency, so that the metal locator can be tuned. This could be accomplished in a number of ways but the method chosen here is a variable capacitor (a standard 100pF AM radio tuner) wired between the two oscillator outputs.

Since the concept borrows from both BFO and IB, we give a nod to each of these by calling the principle "Beat Balance".

Characteristics

The main characteristics of beat balance (BB) are as follows:

- Depending on the way it is designed, a BB metal locator potentially offers the same sensitivity as IB.
- It requires no receiver amplifier or level detector, thus vastly simplifying design and reducing cost. The present circuit uses just two main components, while matching the performance of a budget IB metal locator (which would probably have 10-20 parts).
- Both search oscillators are identical, therefore BB offers high immunity to voltage and temperature variations. This obviates the need for compensation circuits, including voltage regulation.
- Each search coil has the opposite response to metal, thus BB has a high degree of immunity to ground mineralisation. At the same time, it offers good discrimination at the point where the two search coils overlap

The circuit

The design is based on the simplest of inverter oscillators.

Let us focus first on IC1a. Since an inductor resists rapid changes in voltage (called reactance), any change in the logic level at IC1a's output (pin 1) is delayed during transfer to inverting input pin 2. An approx. $8V/\mu s$ slew rate further delays switching

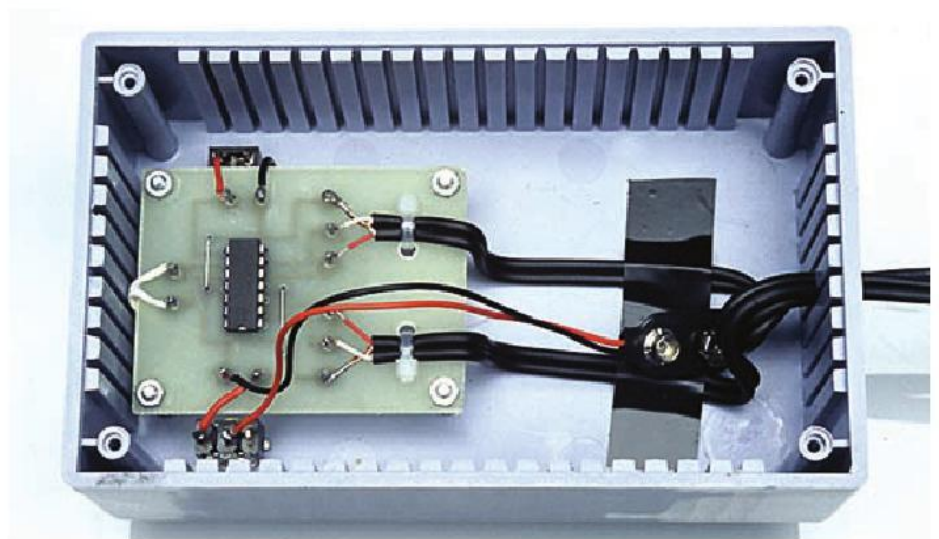

This view inside the box shows the WHOLE circuit (with the exception of the coils, of course, and the tuning capacitor hidden under the PC board).

of IC1a, thus setting up a rapid oscillation.

One end of the search coil is further wired to the non-inverting input (pin 3), which stabilises operation. While pin 3 could be left "floating", this would be a less satisfactory arrangement.

Since different ICs have different slew rates, as well as different input impedances, they are unlikely to work in this circuit. However, the TL074CN IC is widely available and there should be no sourcing problems.

The search coil is a critical part of the oscillator and needs to be suitably

designed to achieve oscillation and to obtain the required frequency.

While this frequency needs to be high, it should not be so high that noise or instability are introduced. Both the characteristics of IC1 and the inductance of the coil influence oscillator frequency, which lies around 260kHz without a Faraday shield. The Faraday shield approximately doubles the inductance of the coil, thus roughly halving the frequency.

IC1b is wired in exactly the same way as IC1a, except that its search coil is connected in opposite phase.

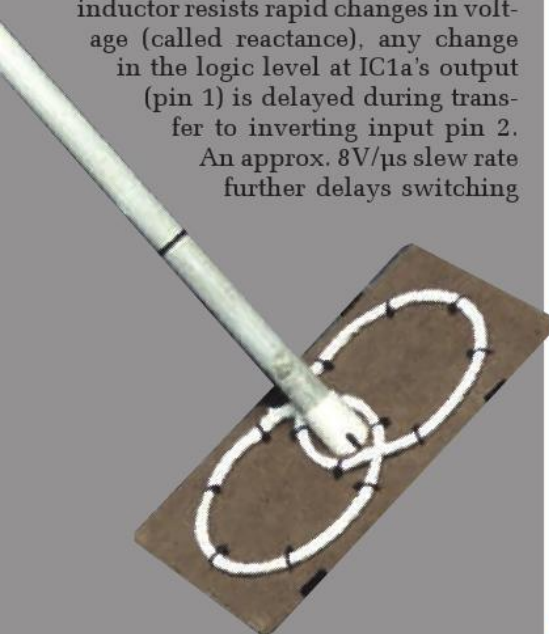
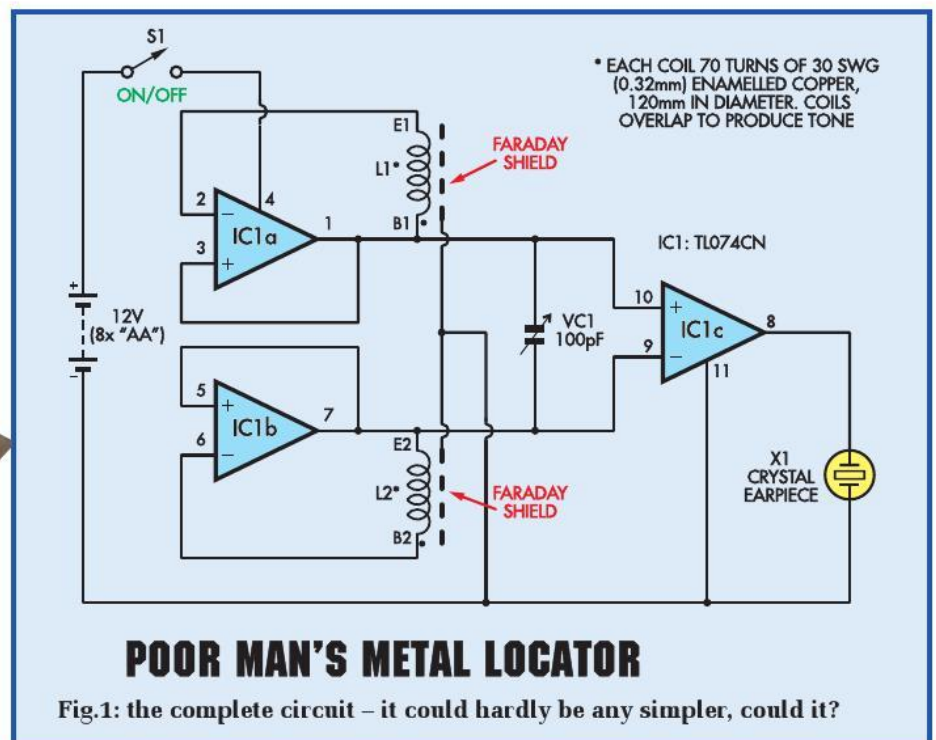

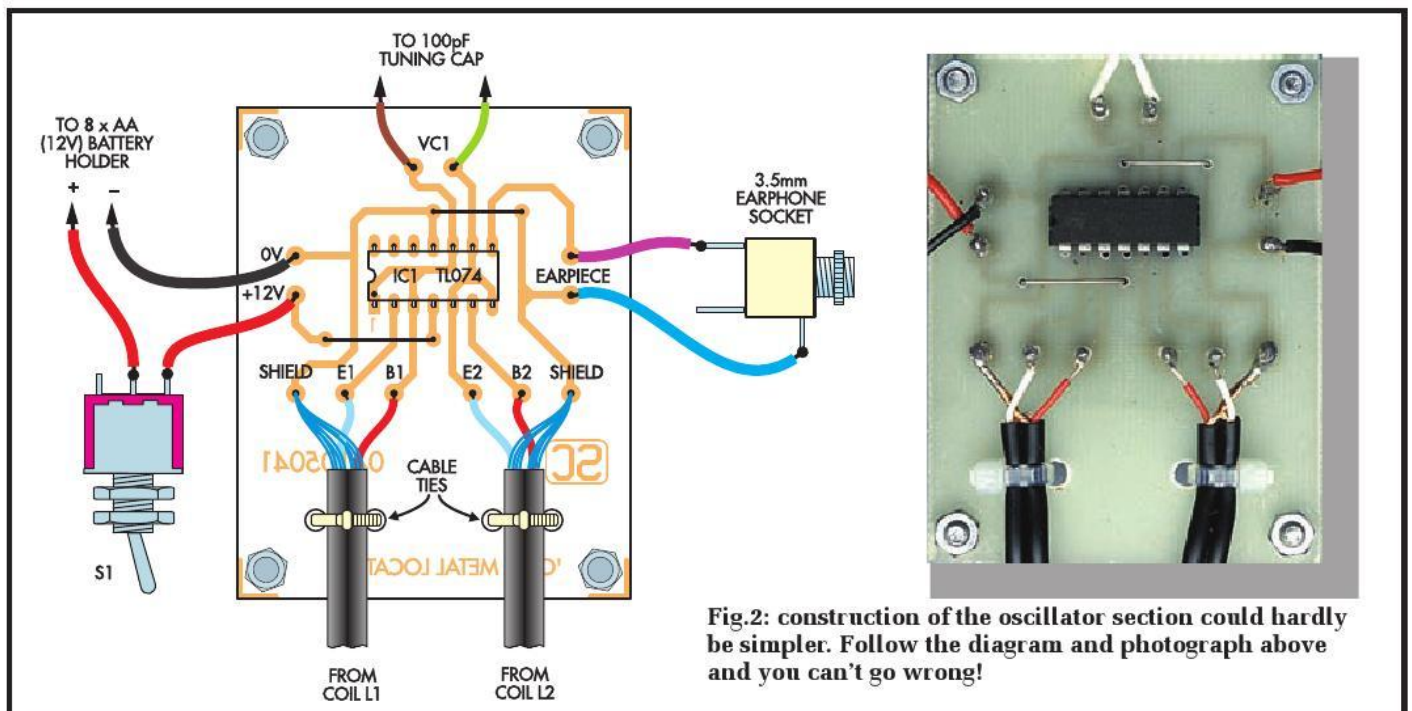

Fig.2: construction of the oscillator section could hardly be simpler. Follow the diagram and photograph above and you can't go wrong!

As the search head is swept over the ground, the presence of metal increases the inductance of L1 and then L2, or vice versa, thus bringing about a dip in the oscillator frequencies. A third op amp, IC1c, is used to mix the output of the oscillators, thus creating an audible difference frequency, or beat frequency.

This leads us to the one distinctive feature of BB. Not only does the presence of metal alter the frequency of a search oscillator but as in the case of IB, it also influences the adjacent coil. In fact, both coils influence each other through mutual induction, thus greatly enhancing the sensitivity of the system.

Beyond this, we only need to find a method of tuning the metal locator. This is achieved using variable capacitor VC1, which further couples the two inductors (the search coils), thus offering a means of controlling balance. Almost any variable capacitor should work in this position, although it should preferably have a smaller value; eg, 47pF to 100pF. A small value capacitor (eg 47pF) can be wired in series with VC1 to reduce a larger value.

A crystal earpiece is used for sound output. While a piezo sounder may be used (without integral electronics), this is not likely to offer good volume. If the volume in the earpiece is too high, use a suitable series resistor to reduce it. An inductive sounder or

earpiece is not recommended, because it could overload IC1c.

Current consumption is around 15mA. Therefore an 8 × AA battery pack should last around 70 hours.

Construction

There's so little on the PC board that it would be difficult to make a mistake. OK, so you could put the IC in back-to-front, likewise the search coils' starts and ends could be inadvertently swapped. Apart from that, there's precious little to worry about.

Fit the 12 stakes to the PC board and solder them into place, then solder the two jumper wires as shown. Normally we would say use resistor lead offcuts for this – but there aren't any! You'll have to use some tinned copper wire instead.

Now comes the challenge of populating the PC board! Since this is a

sensitive, high-frequency circuit, I would recommend that IC1 be soldered directly to the PC board (ie, not socketed). So long as you insert this component the right way round, there would appear to be little to go wrong! The TL074CN is a fairly "tough bird" – but be reasonably quick with the soldering iron.

Wire up the variable capacitor VC1, the socket for the crystal earpiece and the battery and switch (carefully note the polarity of the battery leads – an error here could destroy the circuit). It's usual to insert the on-off switch in the positive battery lead. Some battery holders have solder tags, others (such as the one we used) need a 9V battery snap to connect them. Again, watch the polarity!

Now mount the on-off switch and the jack socket (for the crystal earpiece) on the case. I used long bolts to clamp

Two overlapping coils are wound using 30SWG wire and fastened to a non-metallic base. Figure-of-8 screened microphone cable connects the coils to the oscillator.

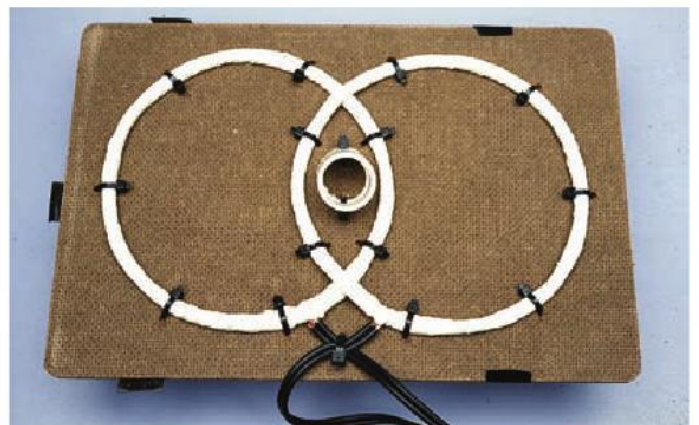

VC1 underneath the PC board and found this an easy and effective way of fixing the variable capacitor to the case. Use a slice of non-conductive rubber to isolate VC1 from the back of the PC board.

Next, wind the two search coils. They are 70 turns of 30SWG (0.315mm) enamelled copper wire on 120mm diameter formers. Faraday electrostatic shields are essential for circuit stability. These are connected to 0V and should use balanced (figure-8) screened microphone cable. Winding of the coils is not critical and a little give and take is permissible. However they should be as close as possible to identical.

Wind the coils around the formers, temporarily holding them together by passing stubs of insulating tape under them and pressing them together over the top. Once you have wound the coils, bind them tightly with insulating tape around their entire circumference. Scrape the enamel off the ends of the coils' enamelled copper wires to solder them to the microphone cables.

Now add Faraday shields. Prepare some long, thin strips of aluminium or tin-foil. Twist a 100mm length of bare wire around each coil, over the insulating tape. This wire provides electrical contact with the foil and is soldered to the microphone cable screens.

Beginning at the base of the bare wires, wind the foil around the circumference of the coils, so that no insulating tape is still visible under the foil – but the foil should not complete a full 360°.

Leave a small gap (say 10mm) so that the foil does not meet after having done most of the round. Now again tightly bind the coils with insulating tape around their entire circumference.

Attach the coils to the circuit by means of the specified microphone

Parts List – Poor Man's Metal Locator

- 1 PC board, code 570 available from the *EPE PCB Service*, 51 x 64mm
- 1 plastic case, 150 x 90 x 50mm
- 1 TL074CN quad op amp (IC1)
- 1 10-100pF variable (tuning) capacitor, with knob
- 1 crystal earpiece
- 1 3.5mm mono earphone socket
- 1 8 x AA battery holder and batteries
- 1 battery snap (if required by holder)
- 1 SPST power switch
- 55m (approx.) 30SWG enamelled copper wire
- 2 lengths twin shielded balanced microphone coax (figure-8), approx. 2m long hookup wire
- 2 20mm lengths tinned copper wire (for PC board links)
- 2 lengths of aluminium foil, approx. 20mm wide (for shield)
- 1 length PVC conduit to suit (handle)
- 4 20mm M3 screws and nuts
- Suitable cable ties
- Clear polyester resin

cables, being careful to identify the beginning and end wires correctly as shown. If these are not correctly identified, there could be a 20% loss of sensitivity. The Faraday shields should be connected to the cable screens and to 0V on the PC board as shown.

Hardware

The "hardware" construction is just as simple as the rest of the design. The two search coils are fixed to a plate of hardboard or Masonite, with a single PVC electrical conduit shaft

attached. The control box, containing all of the electronics apart from the coils, attaches to the shaft via a pair of cable ties.

The top of the shaft is then held in the hand just above the control box, while its upper length rests against the back of one's forearm.

Use a stiff, non-metallic plate for the search head. Hardboard or Masonite is both stiff and easy to work with (I cut up an old Masonite clipboard for the purpose). Before the coils (or anything else) are attached to the baseplate, their best operating position needs to be determined.

Begin by placing the two coils on the search head plate, directly on top of one another (that is, "meshed"), with their beginning and end wires positioned as shown. Turn VC1 to its mid-position. Switch the detector on, then slowly move the coils apart.

When the coils have all but been separated from one another, a tone will be heard in the crystal earpiece. Adjust the coil positions so that this is a fairly low tone – then drill holes and use cable ties (several for each coil) to fasten them in this position on the plate.

Once the cable ties have been tightened, carefully bend the coils until a low tone is again heard in the crystal earpiece. To lower the tone, create a greater overlap of the two coils (ie, a larger segment in the middle), and vice versa.

To construct a shaft, saw the end off a length of PVC piping at a 25° angle. Drill holes through the pipe close to its bottom end and holes through the centre of the search plate. Then bind the pipe to the search plate with cable ties. The pipe (or shaft) will later be fixed permanently to the search plate with clear polyester resin (see photographs).



The lid is secured to the PVC pipe by means of a couple of cable ties. When these are pulled tight, they really grip well! Then the lid (which is effectively now the base) is screwed onto the box – and presto!



The “works” box (left) is mounted near the top of the PVC tube. This view shows the front of the box, with the earpiece socket, tuning capacitor and on/off switch. We haven’t put a fancy label on this project – it would sort of ruin the effect, wouldn’t it? Besides, the label would be on the underside. At right is the coil end, showing how it mounts to the PVC tube.

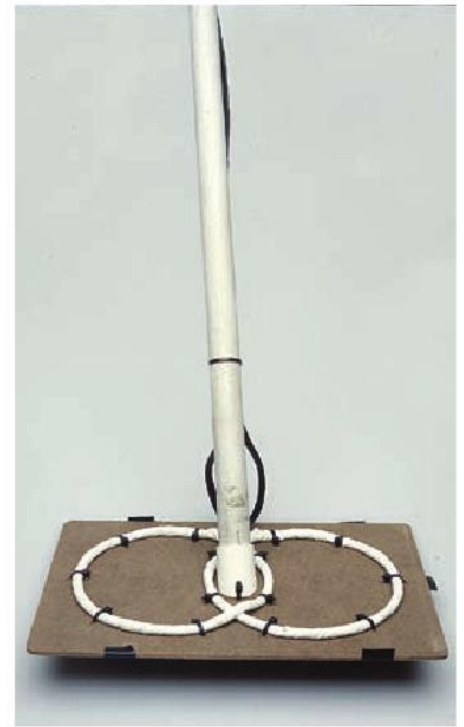

The two coils need to be set rigidly in position on the search head, so that they will not move even slightly when the metal locator is in use. I would recommend that they be potted in clear epoxy resin, which is available from most hardware stores, together with the necessary hardener or catalyst.

A section of one coil should be left exposed where the two coils intersect, so as to enable final fine adjustment. This section of coil may be temporarily protected with Blu-Tac.

Be sure to plug the holes beneath the search head before pouring the resin, since it is very runny and sticks faster than many glues! The detector’s PVC shaft is bound to the search head with the resin.

I tied the control box to the shaft with cable ties and used a little all-purpose glue to assist. Cable ties were further used to bind the cables to the shaft. No hand grip was attached to the prototype but the shaft was kept long at the top, so as to rest against the back of my forearm as I gripped the shaft with my hand.

Checking it out

Once construction is complete and everything checked, switch on and tune VC1 until a clear difference

frequency or heterodyne is heard in the crystal earpiece. This should ideally be a low tone of just a few tens of Hertz. It will be found that sensitivity is dependent to some extent on tone and some experimentation will yield the best frequency. If necessary, further adjust the coils, moving them further apart if the circuit is silent, or closer together if the frequency is too high.

Bring a metal item close to the coils. It will be found that one coil causes the tone in the crystal earpiece to rise, while the other causes it to fall, with the overlapping segment offering discrimination between ferrous and non-ferrous metals.

The detector should pick up a large coin (eg, 50p) at up to 150mm in air (125mm is a sure bet), while large metal objects (eg, a cake tin) will be detected at half a metre. At close range, it is capable of picking up a pin. When in use, hold the search head close to the ground, sweeping it to and fro. Unlike IB, the two coils give opposite responses to metal, which one soon becomes accustomed to.

While the detector is unusually stable, readjustment by means of VC1 will inevitably be required, particularly immediately after switch-on. **EPE**

The Patent That Came Close – But No Cigar!

US Patent 4,196,391 of 1980, by Harold J Weber, was a good piece of original thinking that makes fascinating reading. It came so close to Beat Balance – but no cigar!

The patent describes a metal locator which uses two transmitters, as does ours, balanced by a variable capacitor. However, the patent seeks “least interaction between the inductors”, while ours is almost entirely dependent on such interaction.

In the patent, a variable capacitor is used to balance the frequencies of the two transmitters. Ours, on the other hand, uses variable capacitor VC1 to obtain a beat frequency.

The patent mixes the two transmitter frequencies with a third frequency from a Beat Oscillator. The purpose of this is to provide binaural location of metal objects, which is the “primary object” of the patent. Ours obtains an audible heterodyne by mixing the two transmitter frequencies directly, its primary object being to boost sensitivity.

Harold J. Weber states in his patent that he is “surprised” to find “pronounced improvement” by alternating the signals in the ears – for which he employs a Gate Oscillator and a Gate Switch Driver. Why the expression of surprise? It is hardly scientific language.

My hunch is that the pronounced improvement lay not in the ears but in the coils. He considered that he had merely invented another “beat frequency detector type”, thus missing a significant breakthrough by a whisker.

Reproduced by arrangement with SILICON CHIP magazine 2006. www.siliconchip.com.au