

SCHEMATIC DIAGRAM

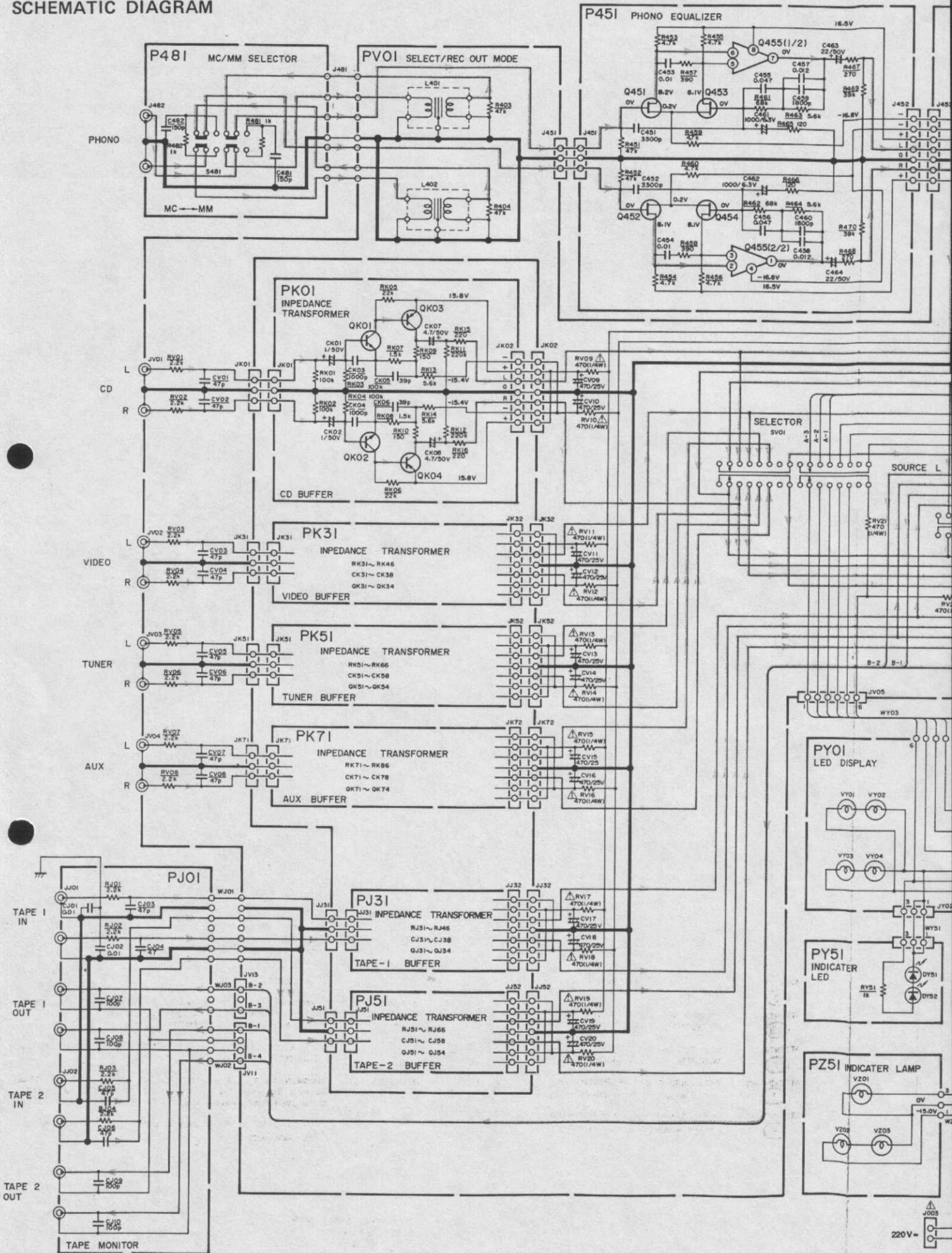

Q801
HC38518090
NJM78M18A

Q802
HC39518090
NJM79M18A

Q803
HC38515090
NJM78M15A

Q804
HC39515090
NJM79M15A

Q701, Q702
HT415080A0
2SD1508

QN03
HT109701A0
2SA970 (G, R)

Q703, Q704
HT32292A0
2SC2229 (O, Y)

QNO4
HC10042050
TA7317P

Q705, Q706
HT101492A0
2SA949 (O, Y)

Q707, Q708
HT332982G0
2SC3298 (O, Y)

D703 ~ D706, DNO4
HD2001000
ISS133, IS2473

Q709, Q710
HT113062G0
2SA1306 (O, Y)

D707, D708
HD30391000
MTZJ3.9A

Q711, Q712
Q715, Q716
HT331822A3
2SC3182 (R, O)

D709, D710
HD30471000
MTZJ4.7B

Q713, Q714
HT112652A3
2SA1265 (R, O)

DNO1, DNO2
HD20014010
ISS81

Q719
HC10229030
STK3102 MK 4

DNO3, DNO5, DNO6
D783 ~ D786
D801 ~ D808
HD20002030
DSF10C

Q455
HC10020360
LM833

D781, D782
HE20009290
SSV20

QE01 ~ QE04
Q451 ~ Q454
HF203691B0
2SK369BL

DNO7
HD30017090
BZ-090

QK01, QK02, QK31, QK32
QK51, QK52, QK71, QK72
QJ31, QJ32
HT324581L0
2SC2458L (G, R)

D711, D712
D713, D714
HD20014010
ISS81

QK03, QK04, QK33, QK34
QK53, QK54, QK73, QK74
QJ33, QJ34, QJ53, QJ54
HT110481L0
2SA1048L (G, R)

DY01 ~ DY20
HI10072320
GL3HD47

QNO1, QNO2
HT322401A0
2SC2240

DY51, DY52
HI10071320
GL3HS47

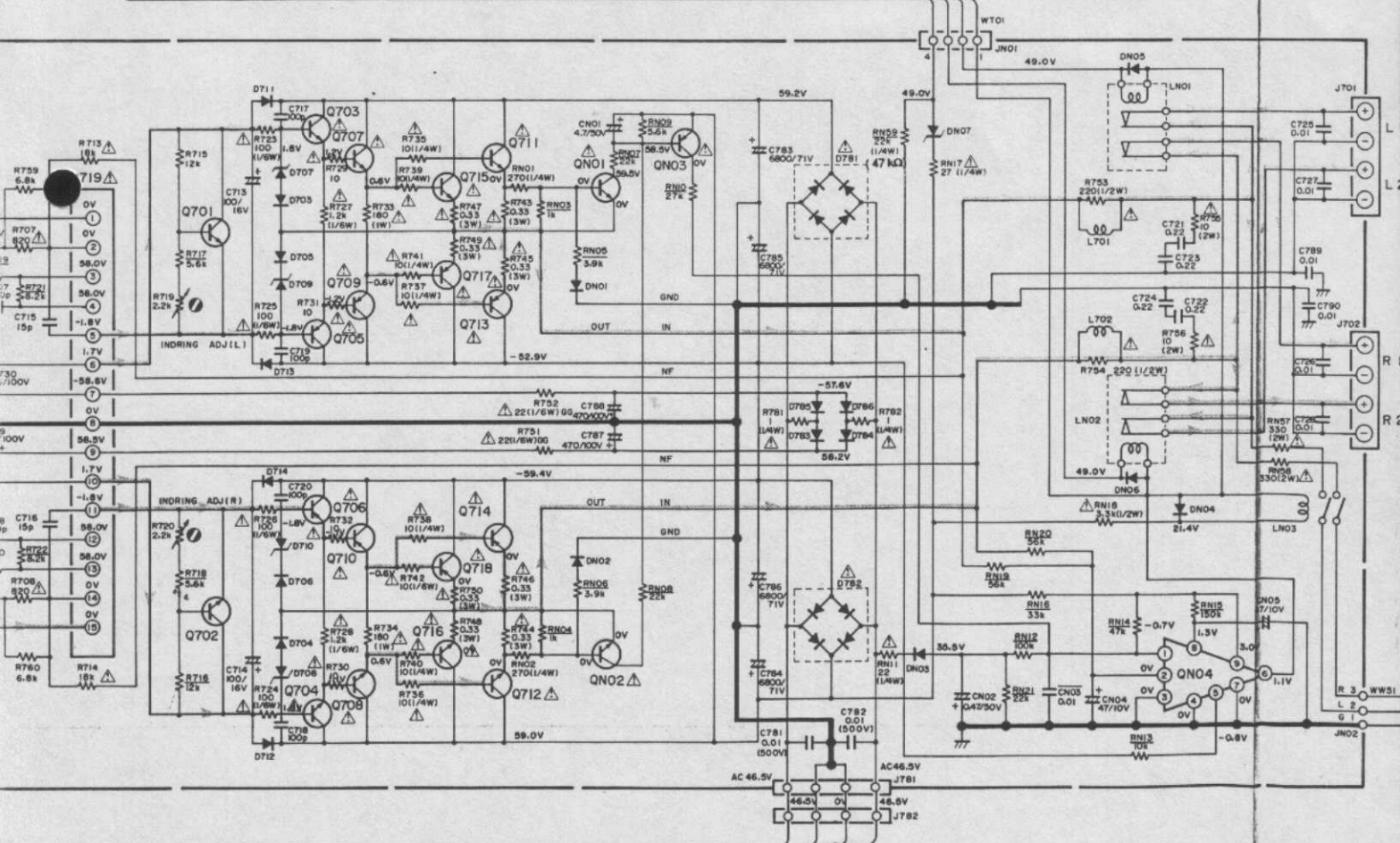
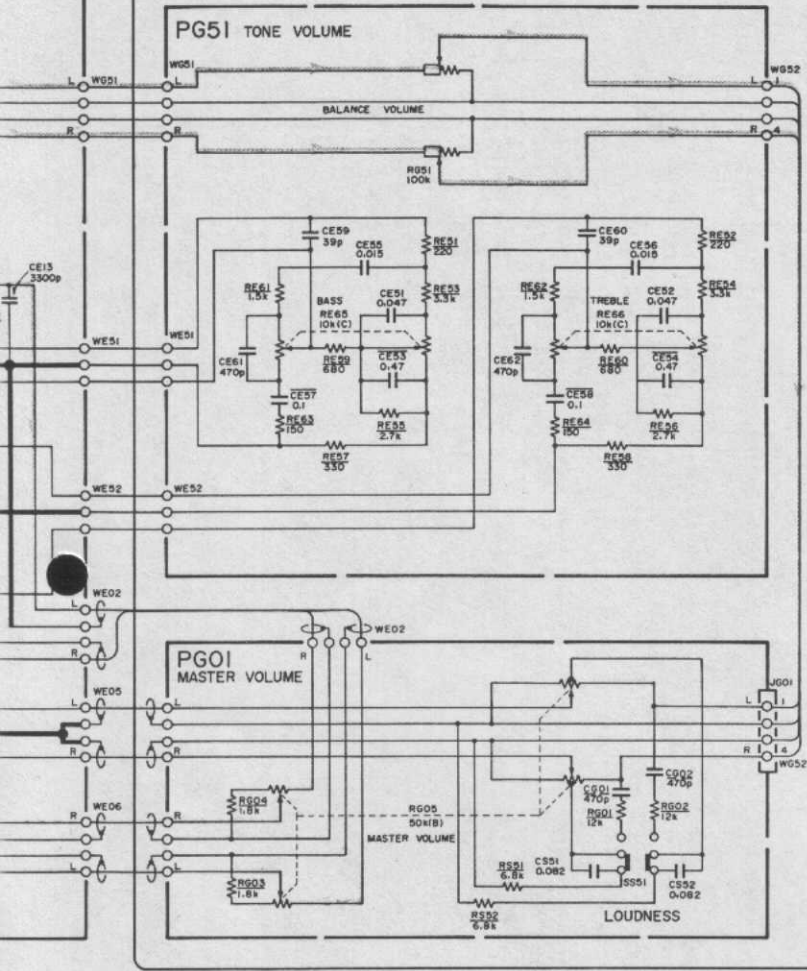

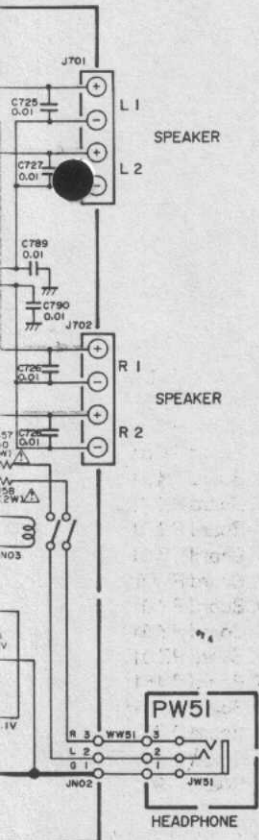
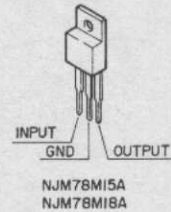
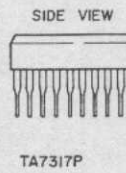
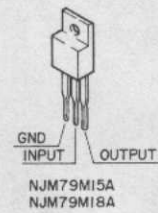
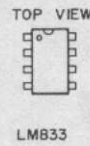
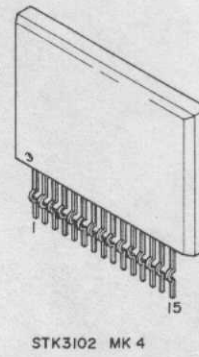
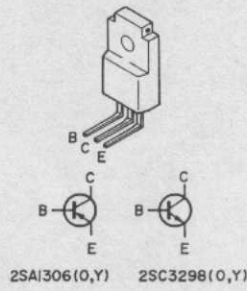
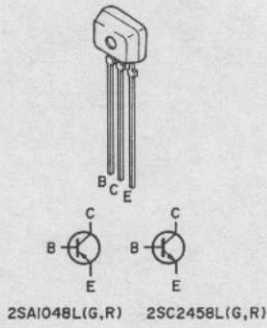
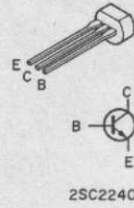
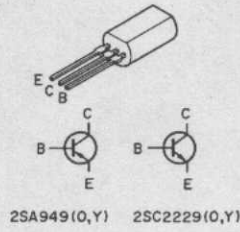
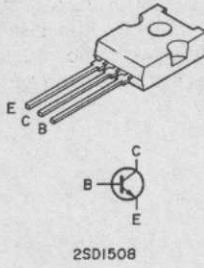
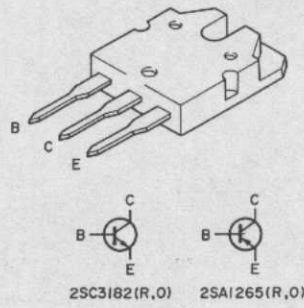
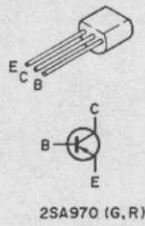
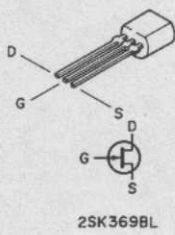

GRUNDIG
A 9000
FINEARTS