

R H46 H132 H55 H11 H22 H82 H26 H12 H124 H27 H38 H48 H51 H54 H43 M01 M02 H57 M06 M07 M10 H62 M12 H13 H68 H71 H73 H76 M19 M20 M21 M22
 H133 H47 H07 H01 H20 H21 H25 H28 H22 H21 H25 H31 H13 H14 H126 H123 H38 H40 H52 H43 M01 M02 H57 H58 M04 H60 M07 M10 M09 H41 M12 H13 H68 H71 H73 H76 M19 M20 M21 M22
 C H03 H14 H15 H13 H24 H87 H27 H33 H17 H89 H128 H129 H50 H53 H28 H56 H59 H37 H67 H69 H72 H74 H77

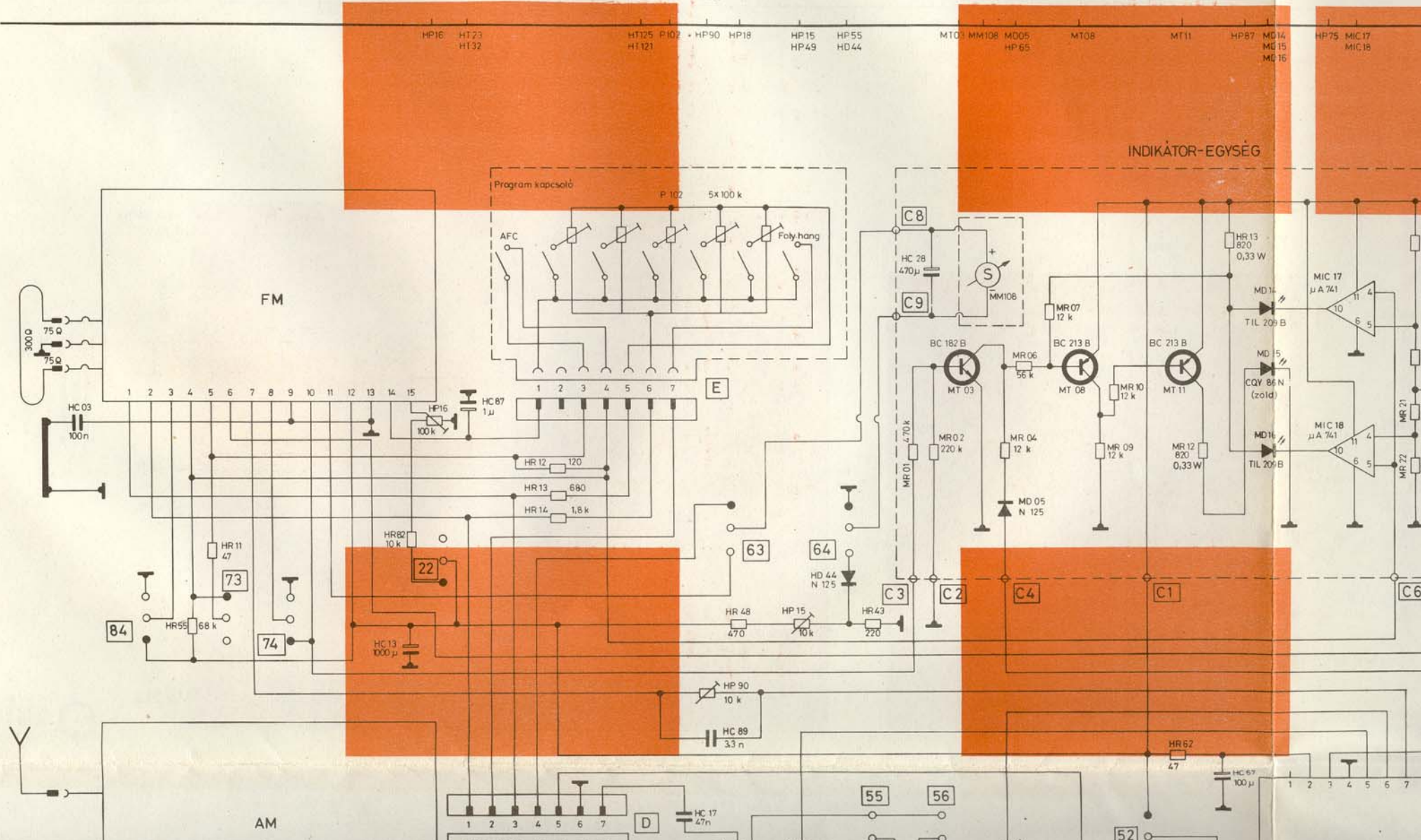

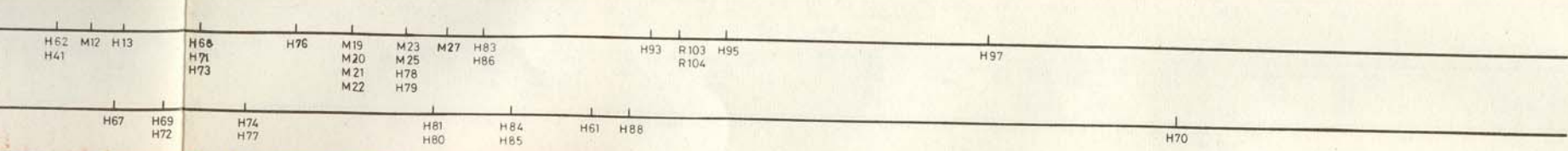

INDIKÁTOR-EGYSÉG

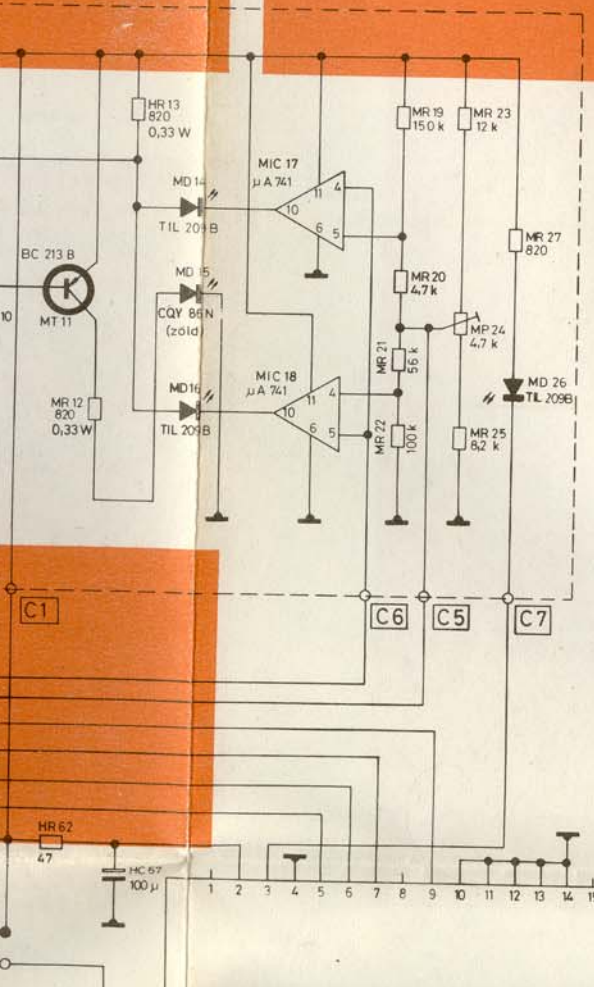

FEJHALLGATÓ

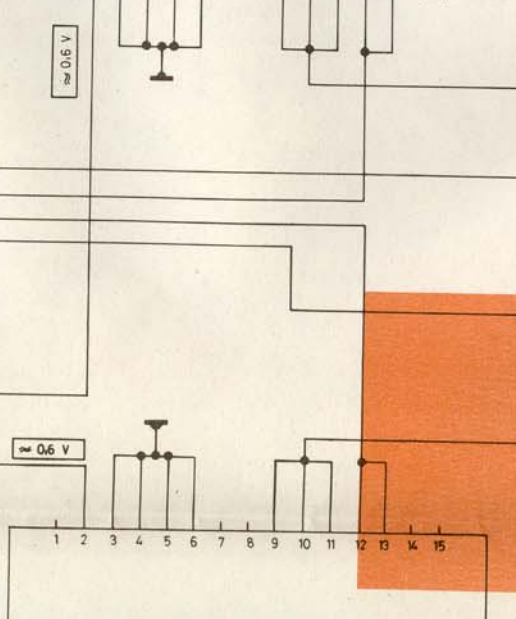
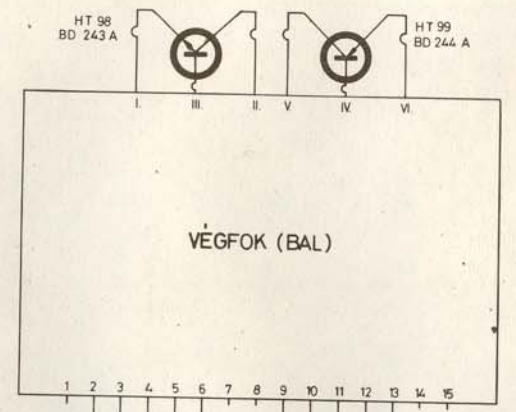
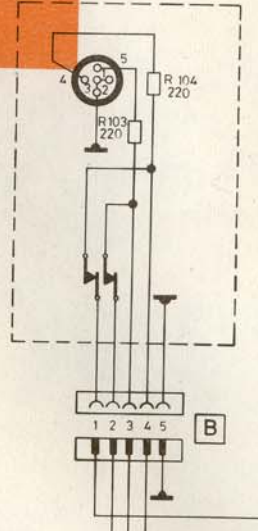

SZTEREÓ DEKÓDER

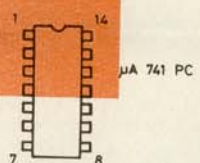
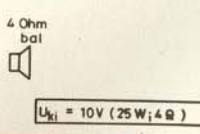
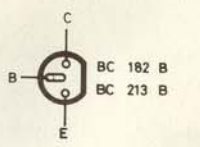
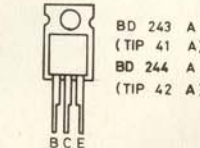
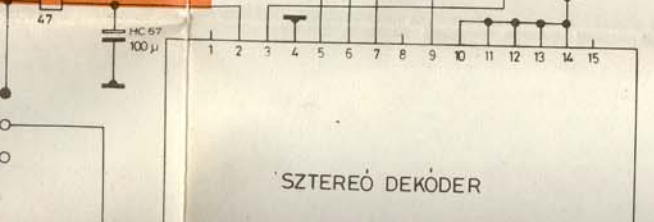

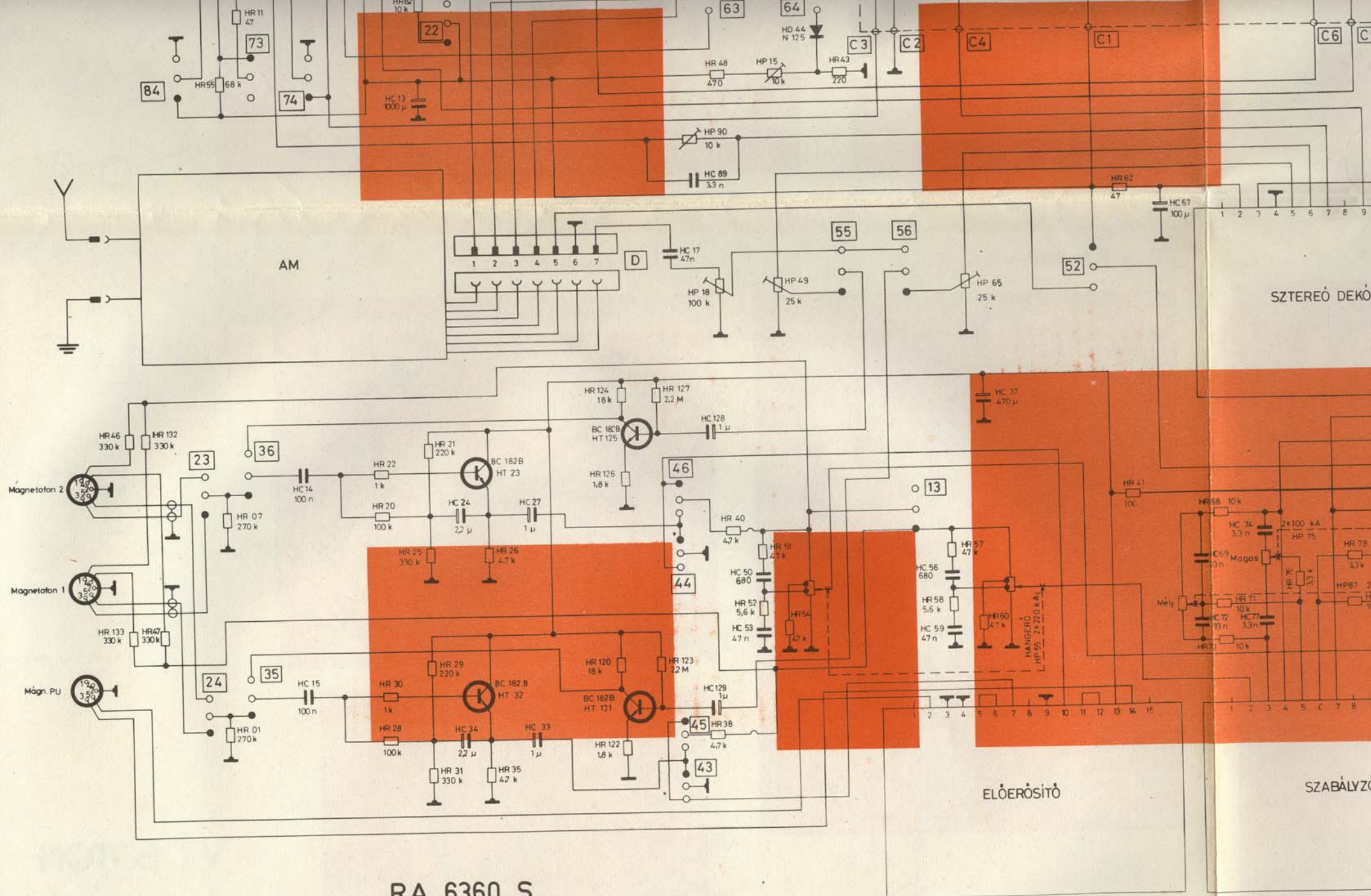

RA 6360 S

A 42
A02

D23	E10	D02	D25	E06	D27	E12	E02	D14	E09	E17	E18	E19	V06	V38	V07	V20	S10	S03	V08	S15	S22	S06	V14	S23	S02	V30									
E01	D06	E30	E23	D17	E16	E35	E36	E37	V34	V38	V26	V35	V39	S26	S18	V09	S32	S35	S16	V19	S36	S07	S37	S17	S19										
D07	D01	D19	D08	D05	D20	E11	D26	D04	D12	E03	D14	D11	E26	E14	E08	E15	V15	V25	S13	V24	V02	V12	V31	T09	T08	T05	S04	S05	S08	S20	S09	V04	V17		
D24	E05	E22	E28	E29	D28	D21	E24	D10	D30	E31	D22	D31	E32	E38	E39	E31							T07	S01	T10	T06	S33	S34	S24	S38	S25	V33			
						D09	D29				D15	D18																							

AP84 AP83 DP03 EIC 20 VT16 VP28 TIC11 VT37 TE04 ST11 VT27 TB03 VT05 ST12 TB02

ST14 ST27 TB12 VT32 TT01 ST28

DEKÓDER-MODUL

VÉGFOK-MODUL

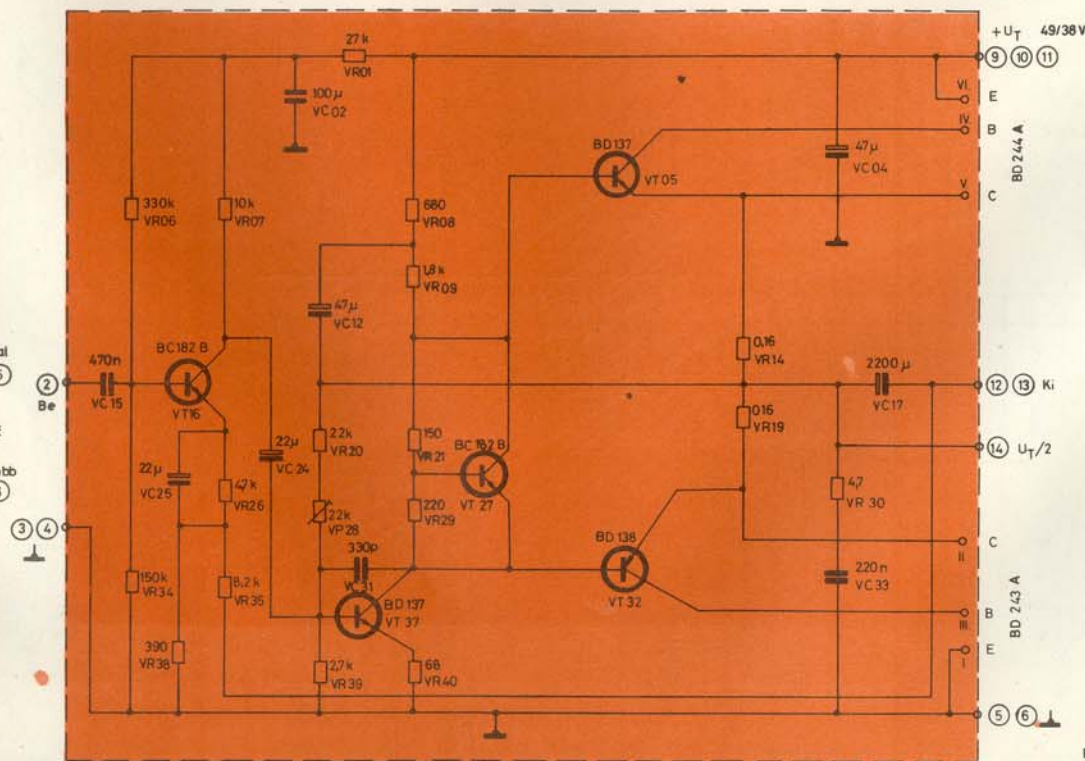
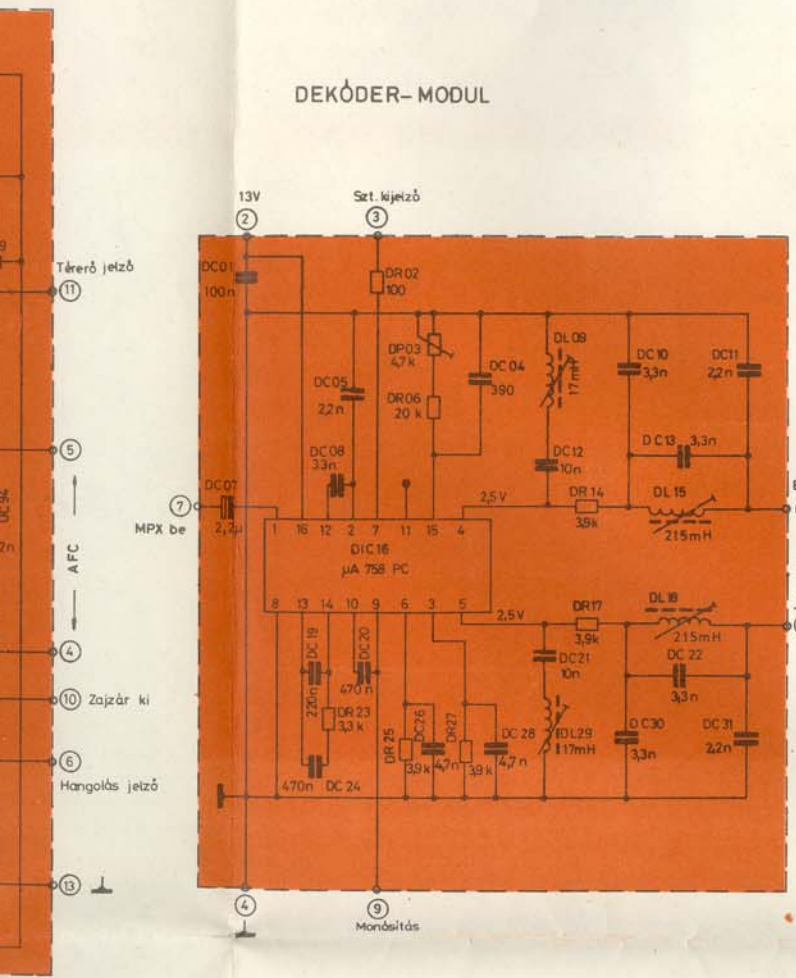

ELŐERŐSÍTŐ-MODUL

SZABÁLYZÓ-MODUL

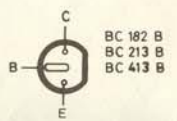
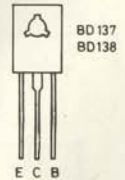

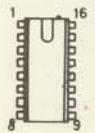

TCA 440
TDA 1062

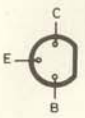
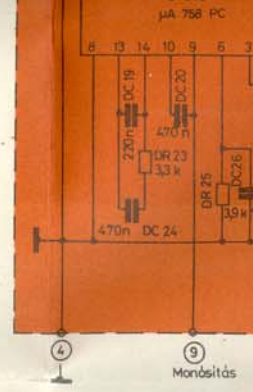
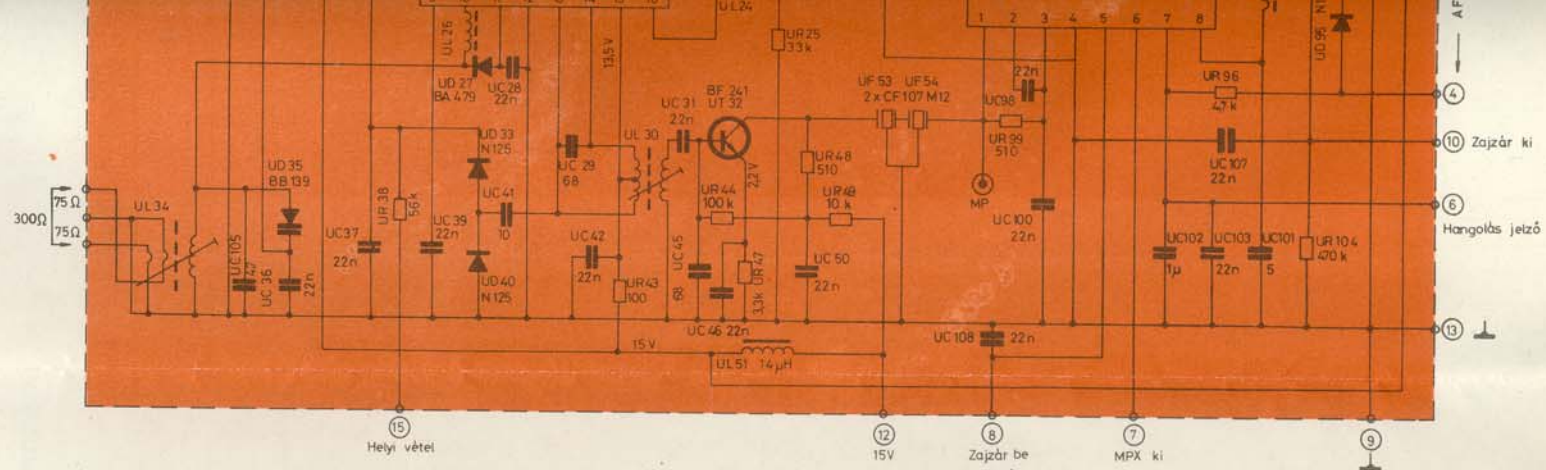

BF 241

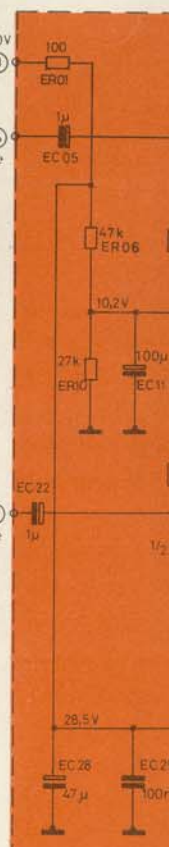
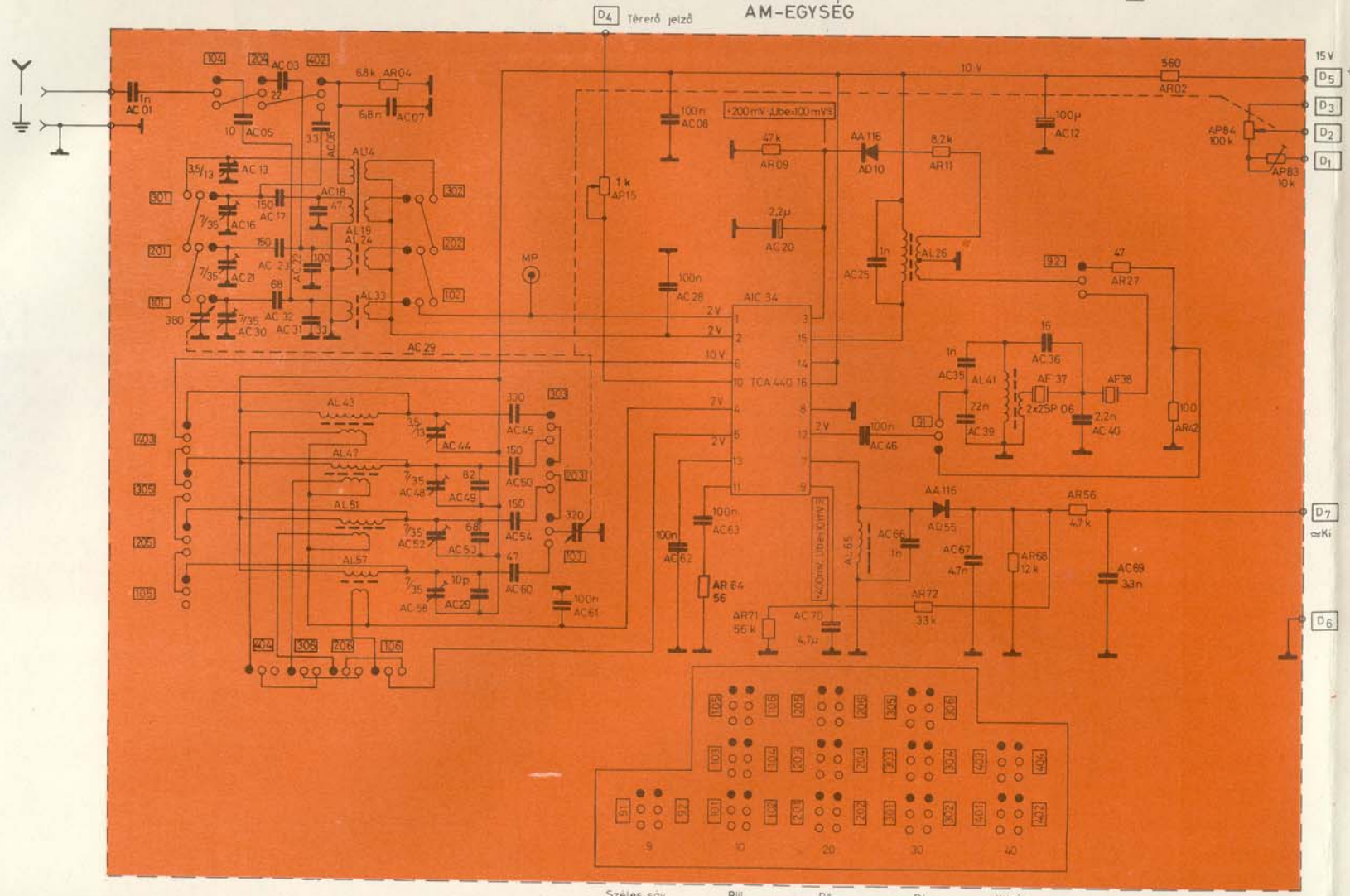

① Modul csatl. számozás

D₄ Kábel csatl. számozás

Széles sáv RII RII RI Közép

ELŐ

RA

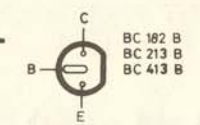
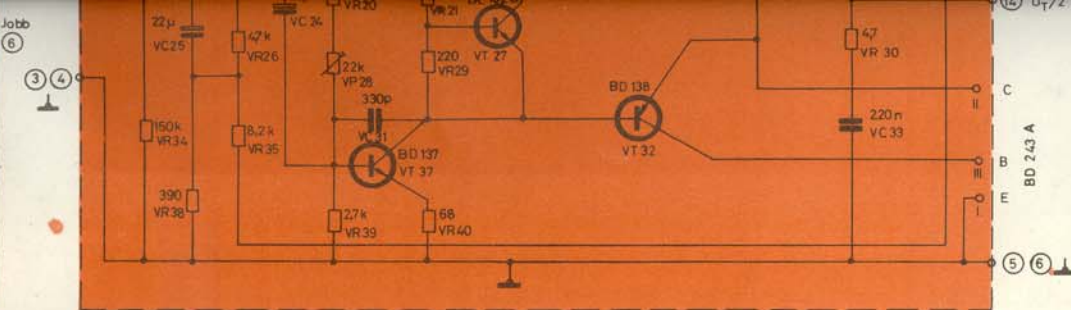
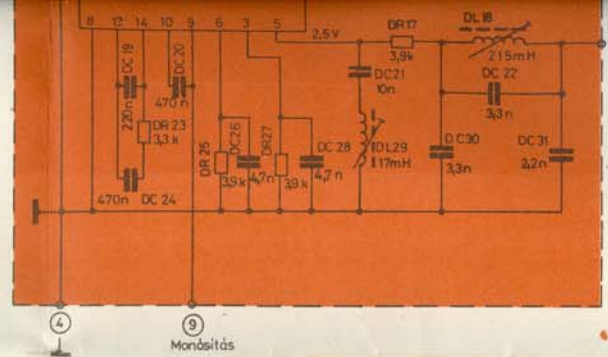

ELŐERŐSÍTŐ-MODUL

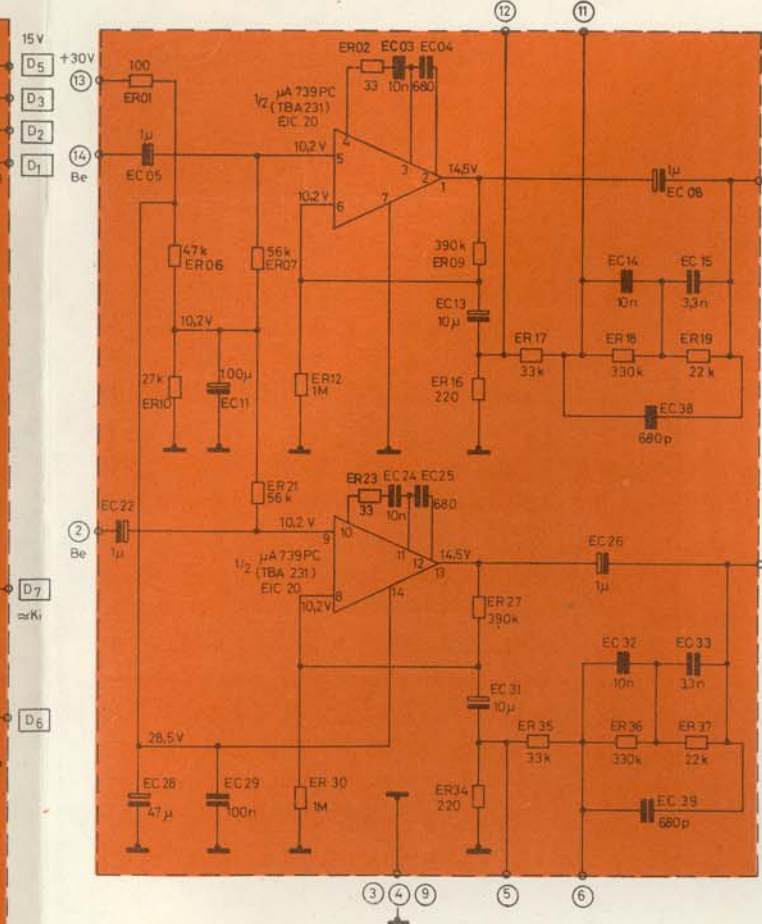

SZABÁLYZÓ-MODUL

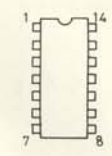
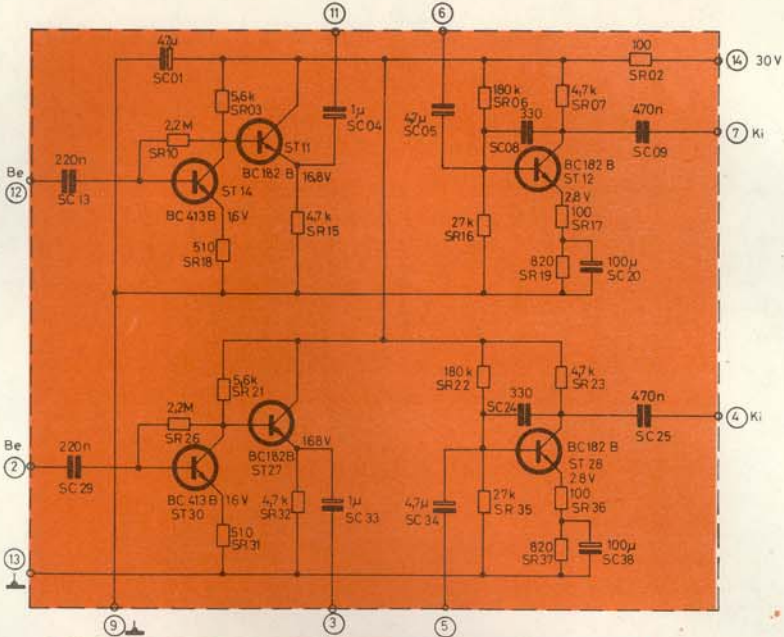

μA 739PC
μA 741PC

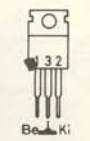

μA 7815 UC



B 40C 3700/2200

RA 6360 S

Kapcsolási rajz

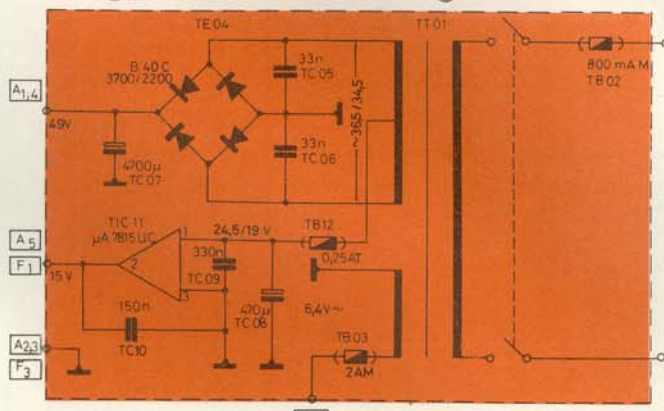

220V ~

VIDEOTON

A VÁLTOZTATÁS JOGÁT FENNTARTJUK!