

Fluorescent display tube level meter driver, 12-point, VU scale, bar display BA6146

The BA6146 is a monolithic fluorescent-display tube driver IC. It can drive a 12-point VU-scale bar-level meter over an input range of -20dB to 8dB . The IC has a low-offset rectifier amplifier, and does not require offset adjustment. It also has built-in on/off muting function.

●Applications

Tape deck and amplifier VU meters.

●Features

- 1) Built-in low-offset rectifier amplifier. No offset adjustment required.
- 2) Built-in power supply muting function.
- 3) The input rectifier amplifier can handle both AC and DC input.
- 4) Wide power supply voltage range (operates from $V_{CC} = 7.5\text{V}$).
- 5) Low operating current (4mA typ.).

●Block diagram

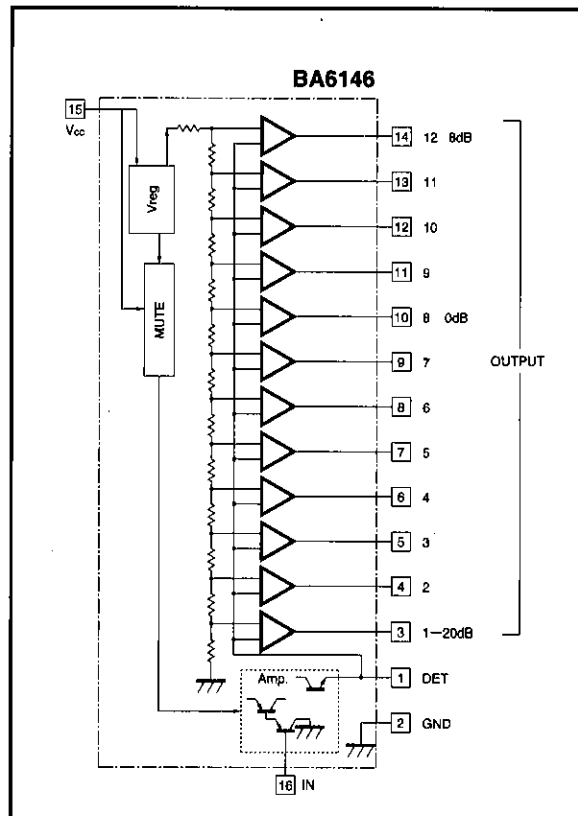

● Absolute maximum ratings (Ta = 25°C)

Parameter	Symbol	Limits	Unit
Supply voltage	V _{CC}	20	V
Power dissipation	P _d	540*	mW
Operating temperature	T _{opr}	-25~75	°C
Storage temperature	T _{stg}	-50~125	°C

* Reduced by 5.4mW for each increase in Ta of 1°C over 25°C.

● Electrical characteristics (unless otherwise specified Ta = 25°C and V_{CC} = 18V)

Parameter	Symbol	Min.	Typ.	Max.	Unit	Conditions	Measurement Circuit
Operating voltage range	V _{CC}	7.5	18	20	V	—	Fig.1
Quiescent current	I _Q	—	4	8	mA	V _{IN} =0V	Fig.1
Input sensitivity	V _{IN}	65	100	140	mV _{rms}	Pin 8 comparator on level	Fig.1
Comparator level 1	V _{C1}	-24	-20	-16	dB	3pin ON	Fig.1
Comparator level 2	V _{C2}	-17.5	-15	-12.5	dB	4pin ON	Fig.1
Comparator level 3	V _{C3}	-11.5	-10	-8.5	dB	5pin ON	Fig.1
Comparator level 4	V _{C4}	-8	-7	-6	dB	6pin ON	Fig.1
Comparator level 5	V _{C5}	-6	-5	-4	dB	7pin ON	Fig.1
Comparator level 6	V _{C6}	-4	-3	-2	dB	8pin ON	Fig.1
Comparator level 7	V _{C7}	-1.5	-1	-0.5	dB	9pin ON	Fig.1
Comparator level 8	V _{C8}	—	0	—	dB	Pin 10 0dB	Fig.1
Comparator level 9	V _{C9}	0.5	1	1.5	dB	11pin ON	Fig.1
Comparator level 10	V _{C10}	2	3	4	dB	12pin ON	Fig.1
Comparator level 11	V _{C11}	4	5	6	dB	13pin ON	Fig.1
Comparator level 12	V _{C12}	6.5	8	9.5	dB	14pin ON	Fig.1
Pin 1 Comparator level	V _{C1}	60	85	—	mV	3pin ON	Fig.1

● Measurement circuit

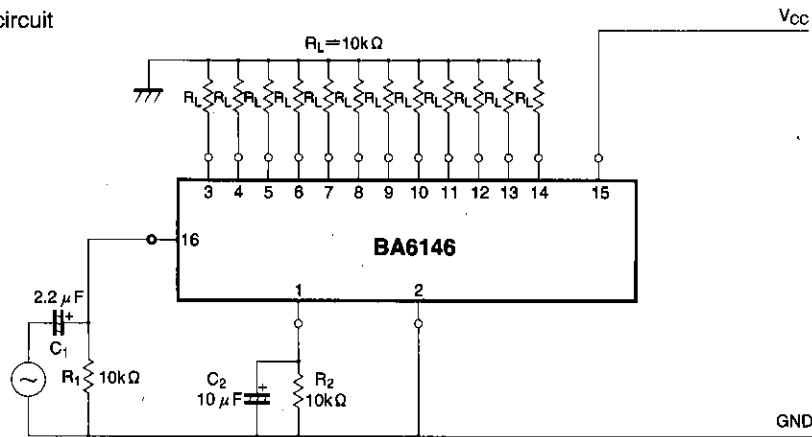

Fig. 1

Level meter drivers
Audio accessory components

●Application example

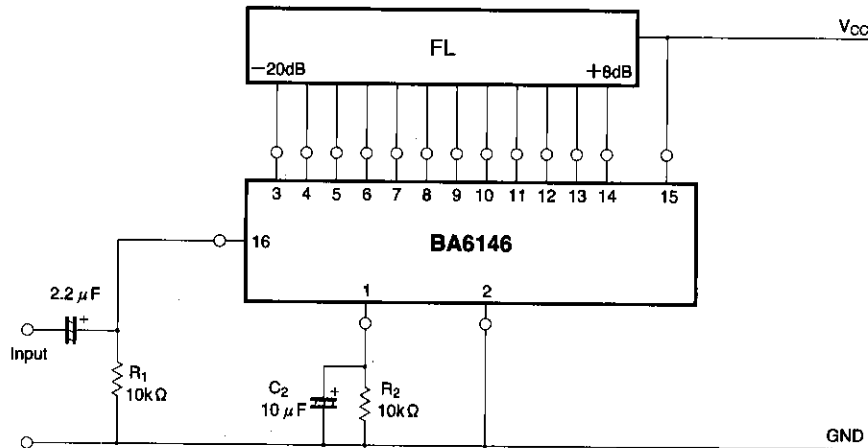

Fig. 2

●External components

(1) Input bias resistor : R_1

This resistor is the input impedance.

If the value of the resistor is large, the DC bias voltage will be large, and the input offset will be large and influence the comparator level.

The recommended value for this resistor is $10k\Omega$.

(2) Time constant setting components for fluorescent tube lighting : C_2 and R_2

C_2 and R_2 approximately determine the recovery time (T_R) according to the following formula.

$$T_R = 2.3 \times C_2 \times R_2$$

The attack time is related to the discharge capacity of the IC and the size of C_2 . When C_2 is $10\mu F$, the attack time is approximately 3ms, and when C_2 is $22\mu F$, the attack time is approximately 7ms.

If the value of R_2 is significantly larger than $10k\Omega$, the comparator level will shift at low levels.

The recommended range is $10k\Omega$ to $25k\Omega$.

●PCB artwork for the application example circuit.

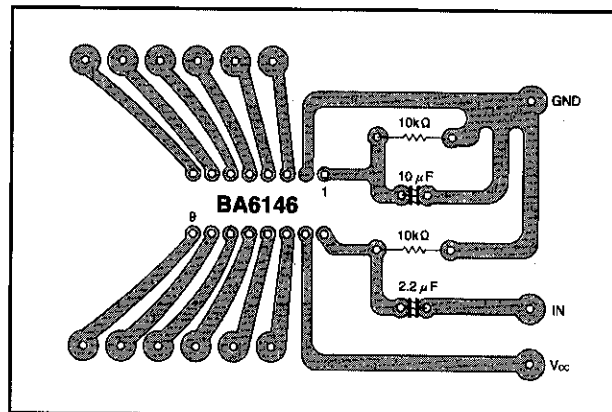

Fig. 3

●Electrical characteristics curves

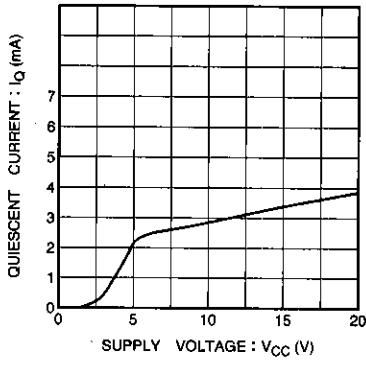

Fig. 4 Quiescent current vs. supply voltage

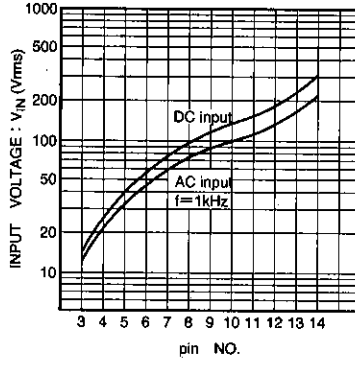
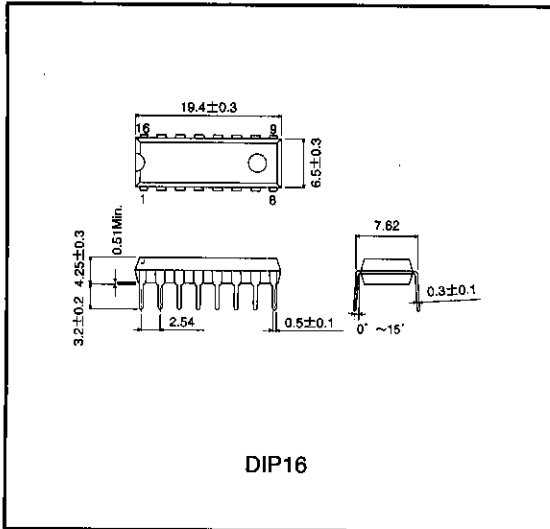

Fig. 5 Lighting input level

●Operation notes

The maximum output current (I_{OUT Max.}) is approximately 2mA.

●External dimensions (Unit: mm)



Level meter drivers

Audio accessory components

This datasheet has been downloaded from:

www.DatasheetCatalog.com

Datasheets for electronic components.