

non reflected

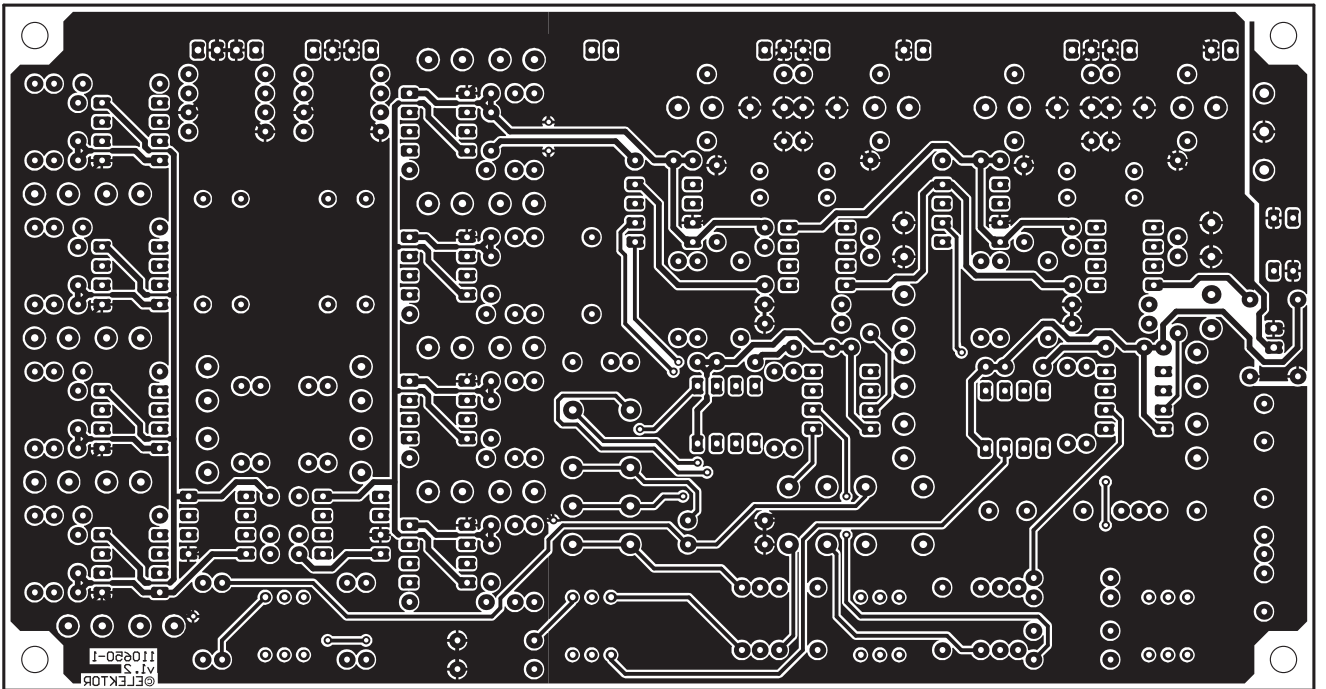

reflected

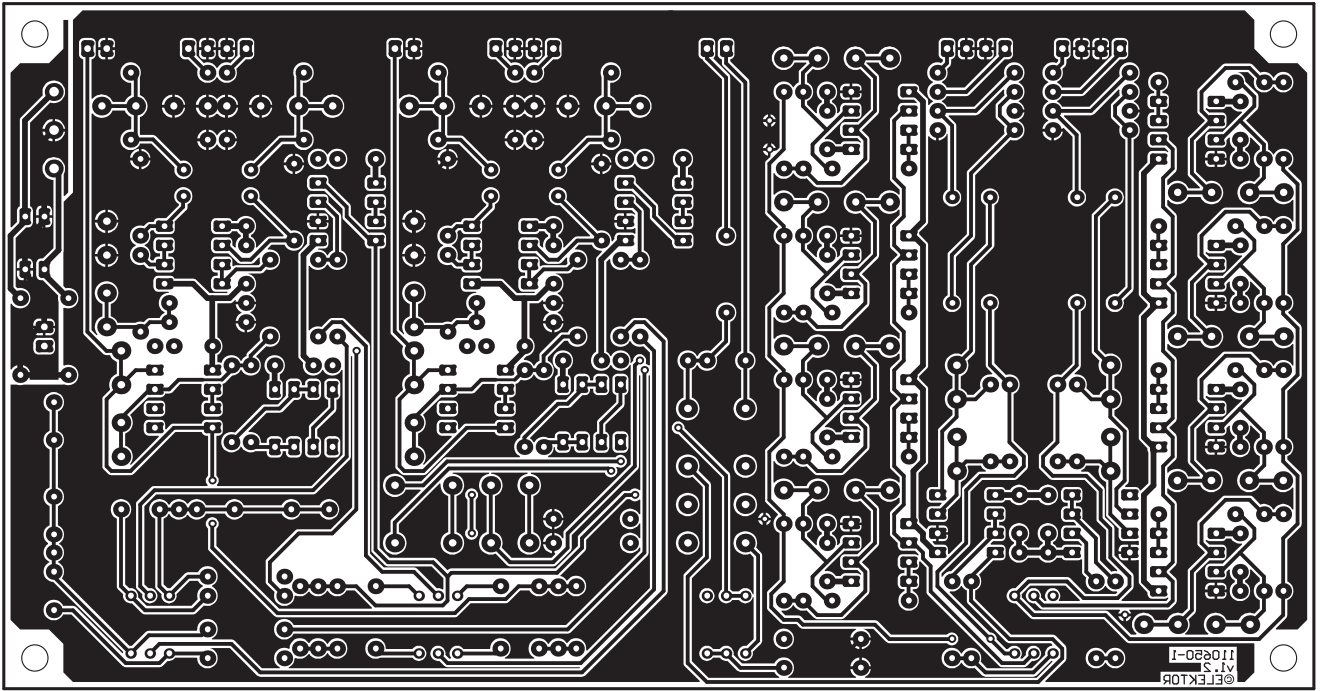
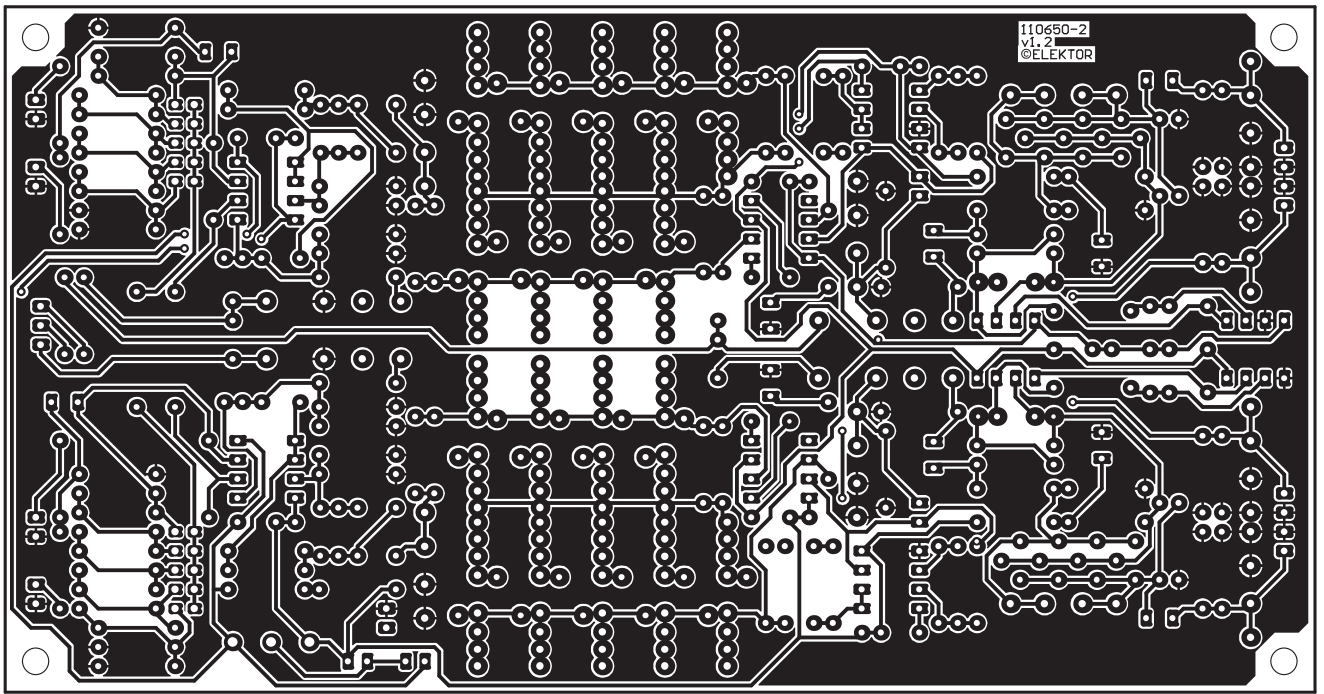

non reflected

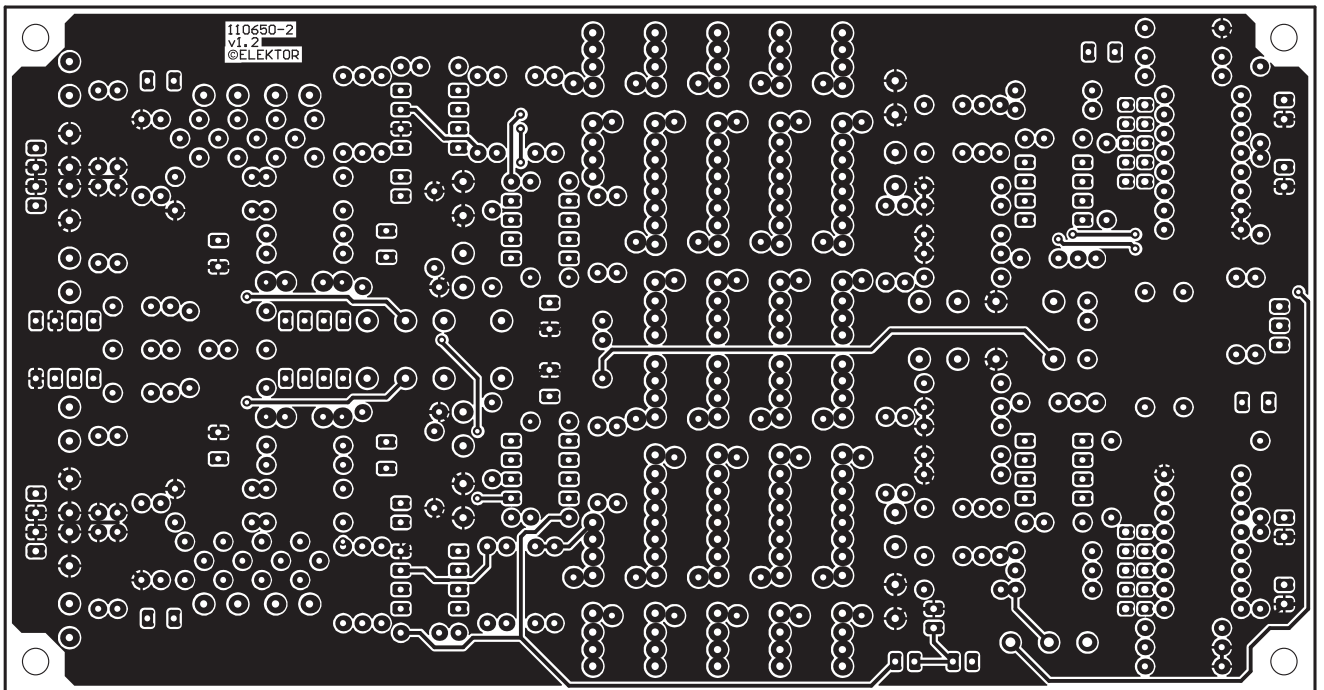

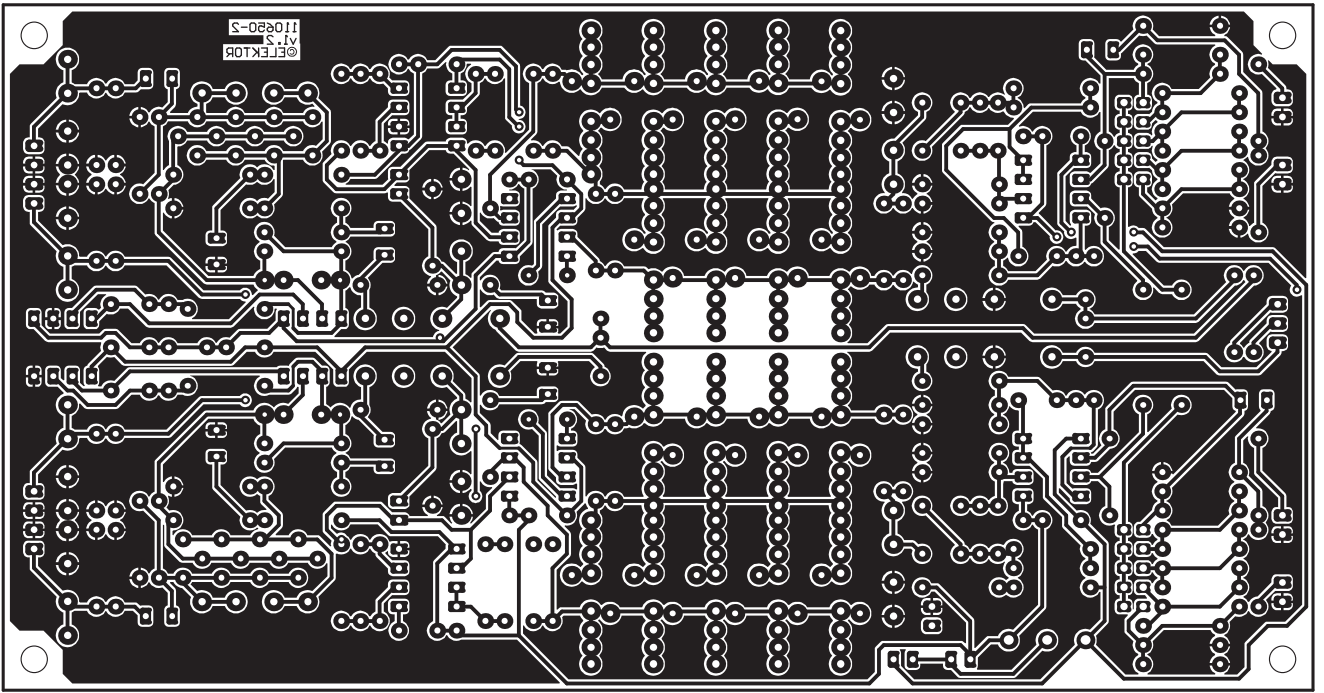

reflected

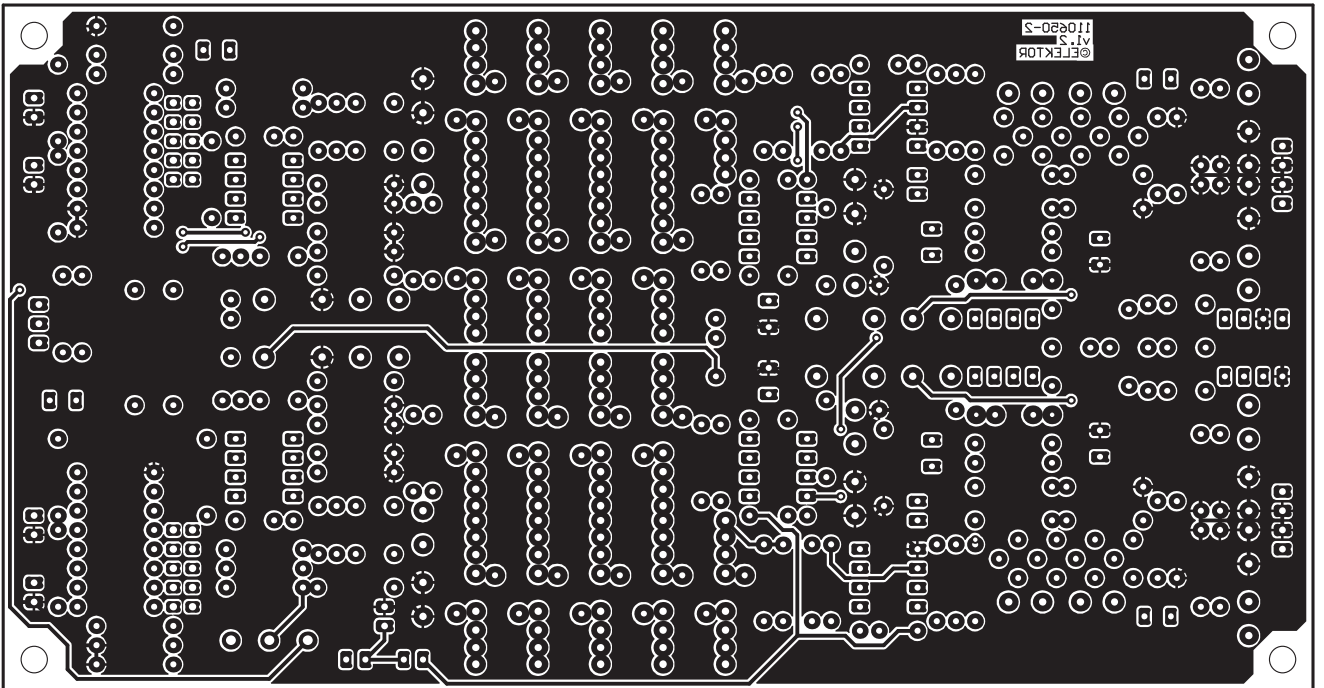

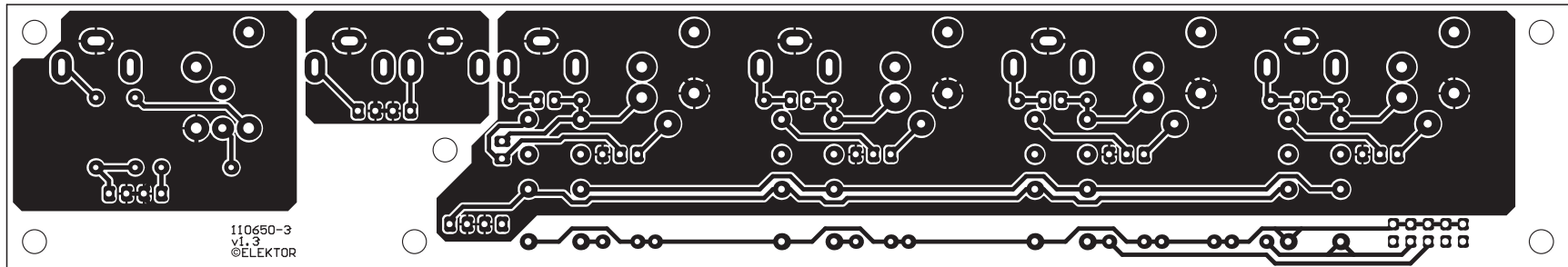

non reflected

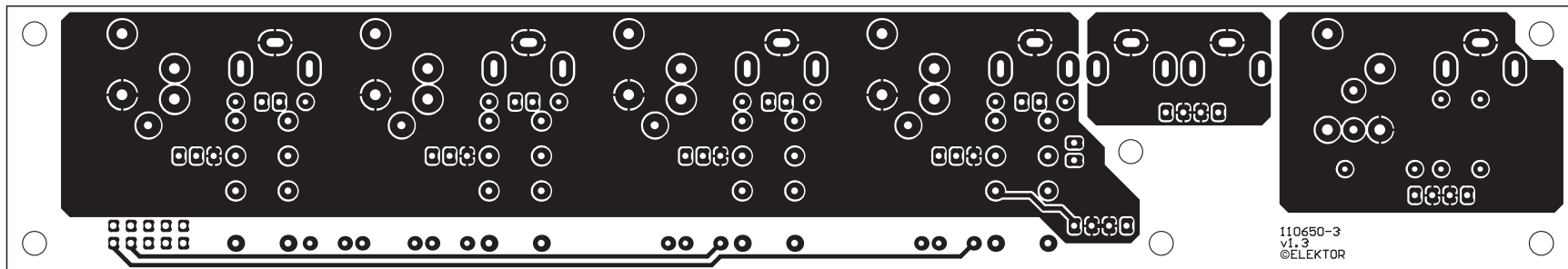



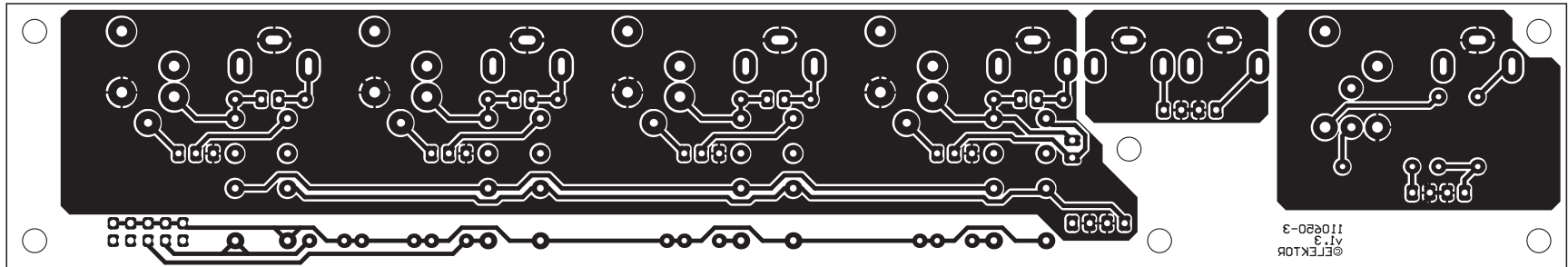

reflected

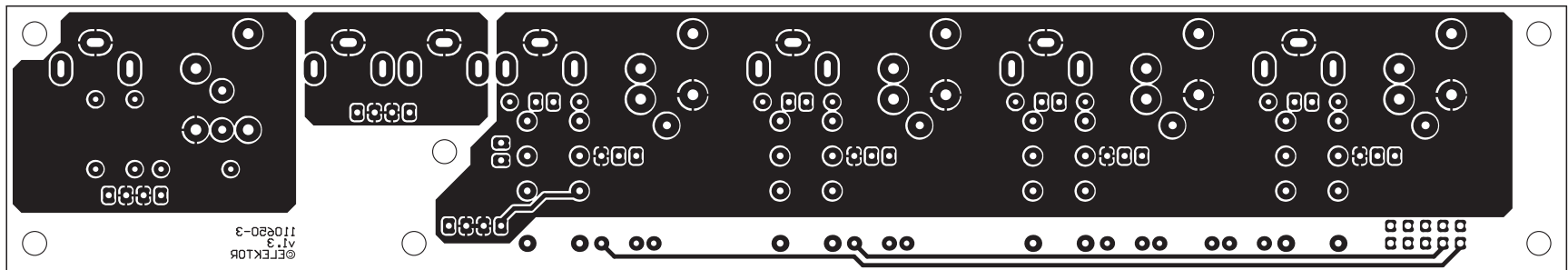

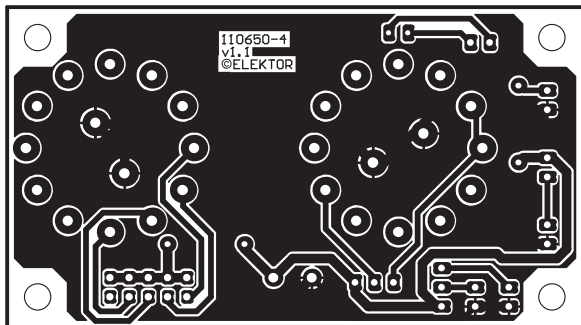

non reflected

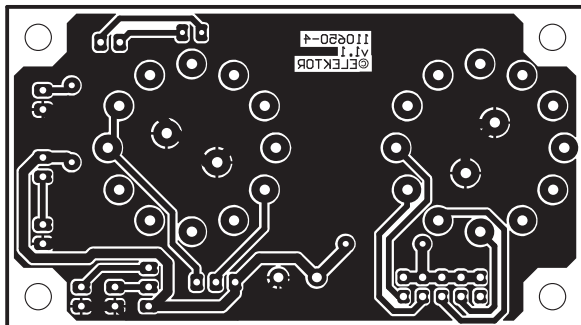

reflected

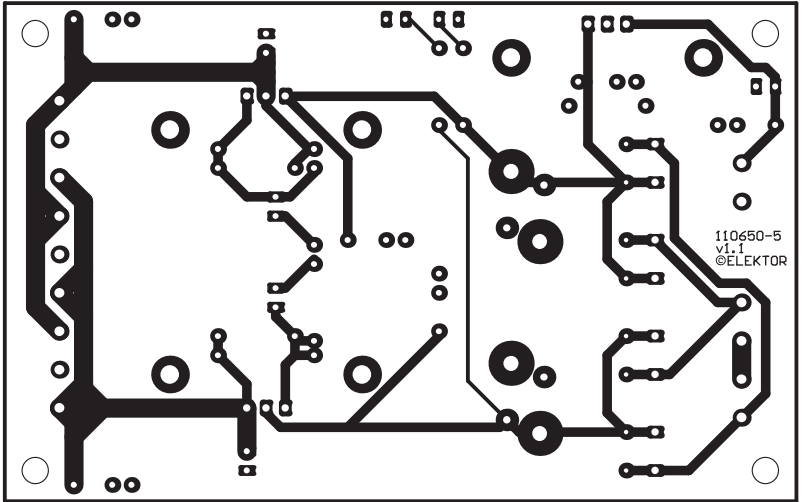

non reflected

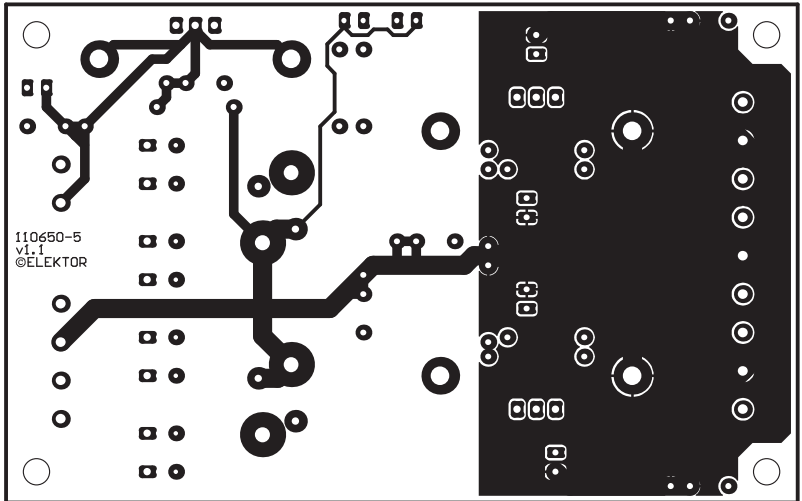



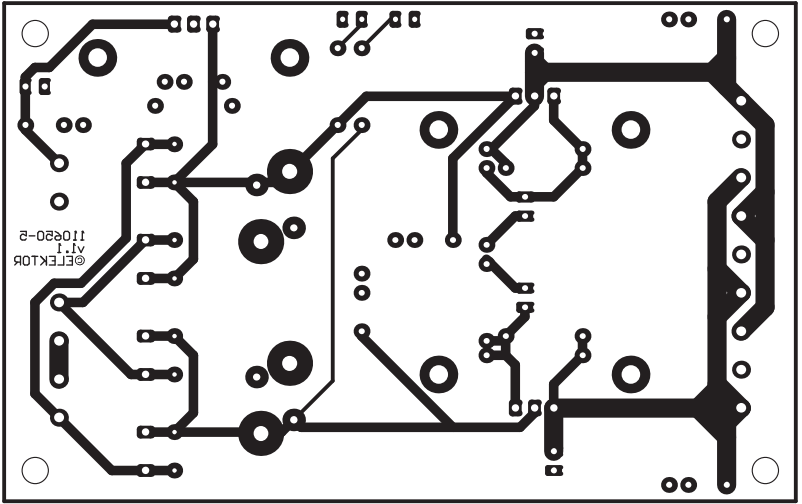

reflected

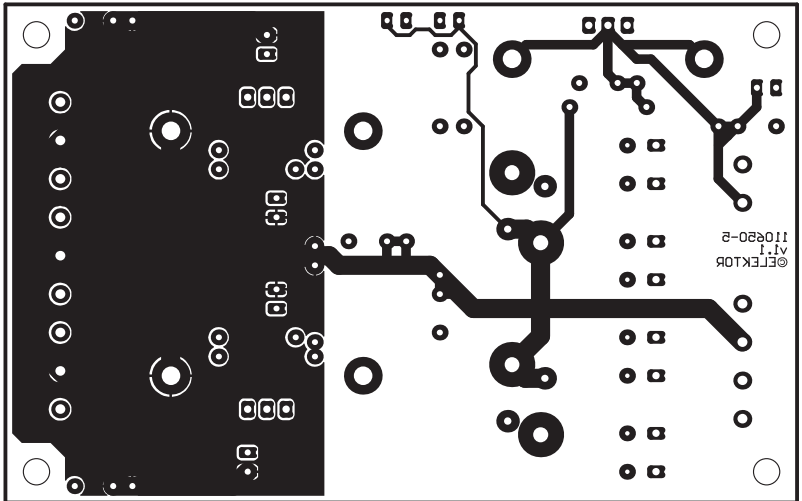

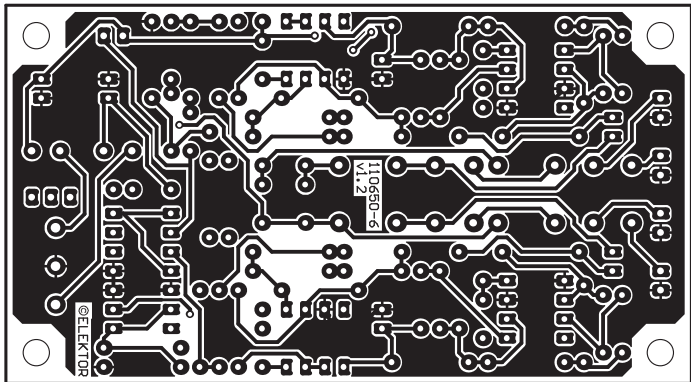

non reflected

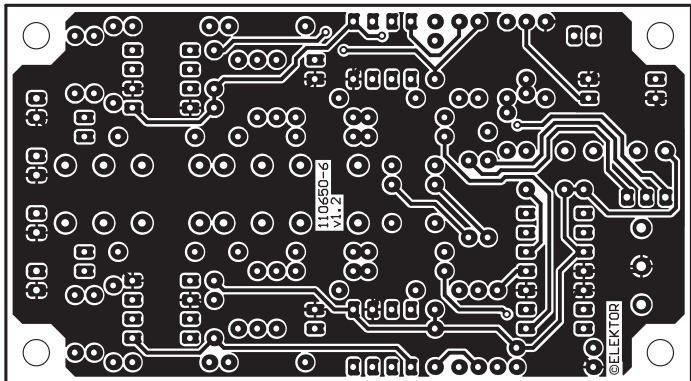

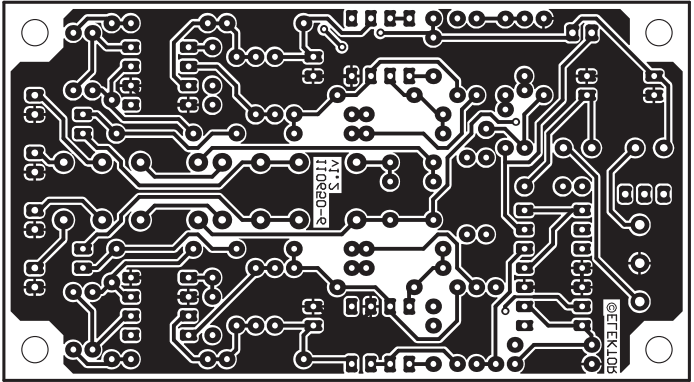

reflected

