



Design Example Report

Title	<i>4.9W power supply using TNY266P</i>
Specification	Input: 90 – 265 VAC Output: 5V/1.5A, 3.3V/1.5A, 12V/0.5A, -12V/15mA
Application	DVD Player
Author	Power Integrations Applications Department
Document Number	DER-10
Date	February 4, 2004
Revision	1.0

Summary and Features

- Low cost
- no common-mode choke
- no Y-cap
- no X-cap
- low EMI even with output grounded
- good output cross-regulation even with no TL431
- ~ 200 mW input power during standby using low-cost “DC Switch”

The products and applications illustrated herein (including circuits external to the products and transformer construction) may be covered by one or more U.S. and foreign patents or potentially by pending U.S. and foreign patent applications assigned to Power Integrations. A complete list of Power Integrations' patents may be found at www.powerint.com.

Table Of Contents

1	Introduction.....	3
2	Photograph.....	4
3	Power Supply Specification.....	5
4	Schematic.....	6
5	Circuit Description	7
5.1	Input EMI Filtering	7
5.2	Primary Clamp Snubber	7
5.3	Output filtering.....	7
5.4	Output Feedback.....	7
5.5	“DC Switch”	7
6	PCB Layout	8
7	Bill Of Materials	9
8	Transformer Specification.....	10
8.1	Electrical Diagram	10
8.2	Electrical Specifications.....	10
8.3	Materials.....	10
8.4	Transformer Build Diagram	11
8.5	Copper Foil Preparation	11
8.6	Transformer Construction.....	12
9	Transformer Spreadsheets.....	13
10	Performance Data.....	16
10.1	Standby Input Power during DC switch off operation	16
10.2	Full-load Efficiency	16
10.3	Input Power Consumption during Standby	16
10.4	Cross Regulation.....	17
	Thermal Performance.....	17
11	Minimum Operating Voltage and Peak Power Margin	17
12	Output ripple and Noise Waveforms	18
13	Conducted EMI	20
14	Revision History	21

Important Notes:

Although this board is designed to satisfy safety isolation requirements, the engineering prototype has not been agency approved. Therefore, all testing should be performed using an isolation transformer to provide the AC input to the prototype board.

Design Reports contain a power supply design specification, schematic, bill of materials, and transformer documentation. Performance data and typical operation characteristics are included. Typically only a single prototype has been built.



1 Introduction

This document is an engineering report describing an 4.9W (8.5 W peak) multiple output power supply utilizing a TNY266P for a DVD player.

This design is low cost and meets EMI with no common-mode choke, no X-cap, and no Y-cap. This is possible with TinySwitch-II because of its built-in frequency jitter.

Cross-regulation is tight in spite of having a simple low-cost zener regulation scheme. This is possible with TinySwitch-II because of its unique feedback scheme.

A low-cost non-Safety rated “DC Switch” allows shutdown with ~200 mW consumption at 230 Vac. This is possible with TinySwitch-II because of its *EcoSmart* features.

This document contains the power supply specification, schematic, bill of materials, transformer documentation, printed circuit layout, and performance data.



2 Photograph

Note the following:

- Does not use common-mode choke, X-cap, nor Y-cap
- Uses little board space
- Does not use a heatsink
- Uses small transformer: EE25L
- Uses small output capacitors
- Uses small output diodes
- Does not use TL431

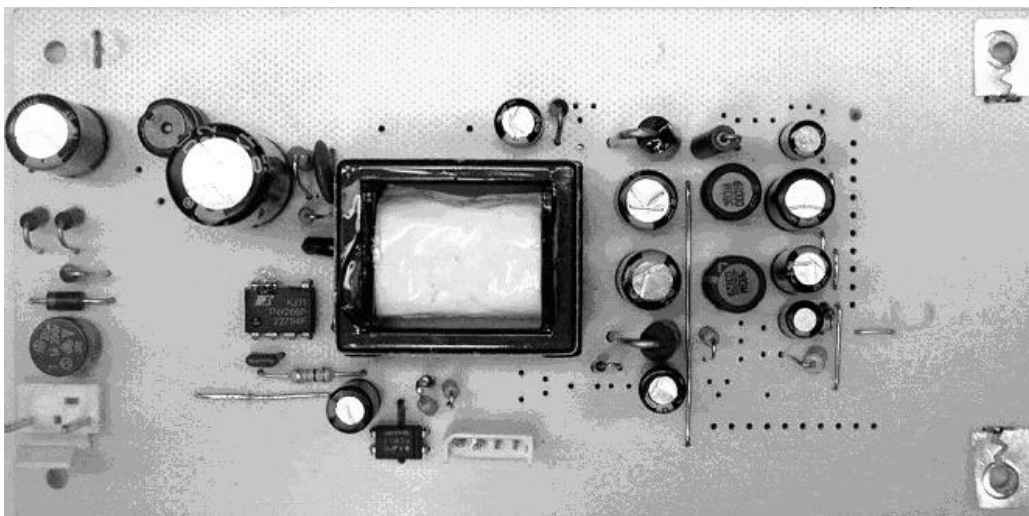

Figure 1 – Power Integrations PSU unit



3 Power Supply Specification

Description	Symbol	Min	Typ	Max	Units	Comment
Input						
Voltage	V_{IN}	90		265	VAC	2 Wire – no P.E.
Frequency	f_{LINE}	47	50/60	64	Hz	
No-load Input Power (230 VAC)				0.3	W	
Output						
Output Voltage 1	V_{OUT1}		3.6		V	20 MHz Bandwidth
Output Ripple Voltage 1	$V_{RIPPLE1}$			50	mV	
Output Current 1	I_{OUT1}		1	1.5	A	
Output Voltage 2	V_{OUT2}		5.0		V	± 5% 20 MHz Bandwidth
Output Ripple Voltage 2	$V_{RIPPLE2}$			50	mV	
Output Current 2	I_{OUT2}		1	1.5	A	
Output Voltage 3	V_{OUT3}		12		V	20 MHz Bandwidth
Output Ripple Voltage 3	$V_{RIPPLE3}$			100	mV	
Output Current 3	I_{OUT3}		0.2	0.5	A	
Output Voltage 4	V_{OUT4}		-12		V	zener regulated 20 MHz Bandwidth
Output Ripple Voltage 4	$V_{RIPPLE4}$			100	mV	
Output Current 4	I_{OUT4}		0.012	0.013	A	
Total Output Power						
Continuous Output Power	P_{OUT}		4.9		W	
Peak Output Power	P_{OUT_PEAK}			8.5	W	
Efficiency	η		71		%	Measured at full load, 25 °C
Environmental						
Conducted EMI			Meets CISPR22B / EN55022B			
Ambient Temperature	T_{AMB}	0		40	°C	Free convection, sea level



4 Schematic

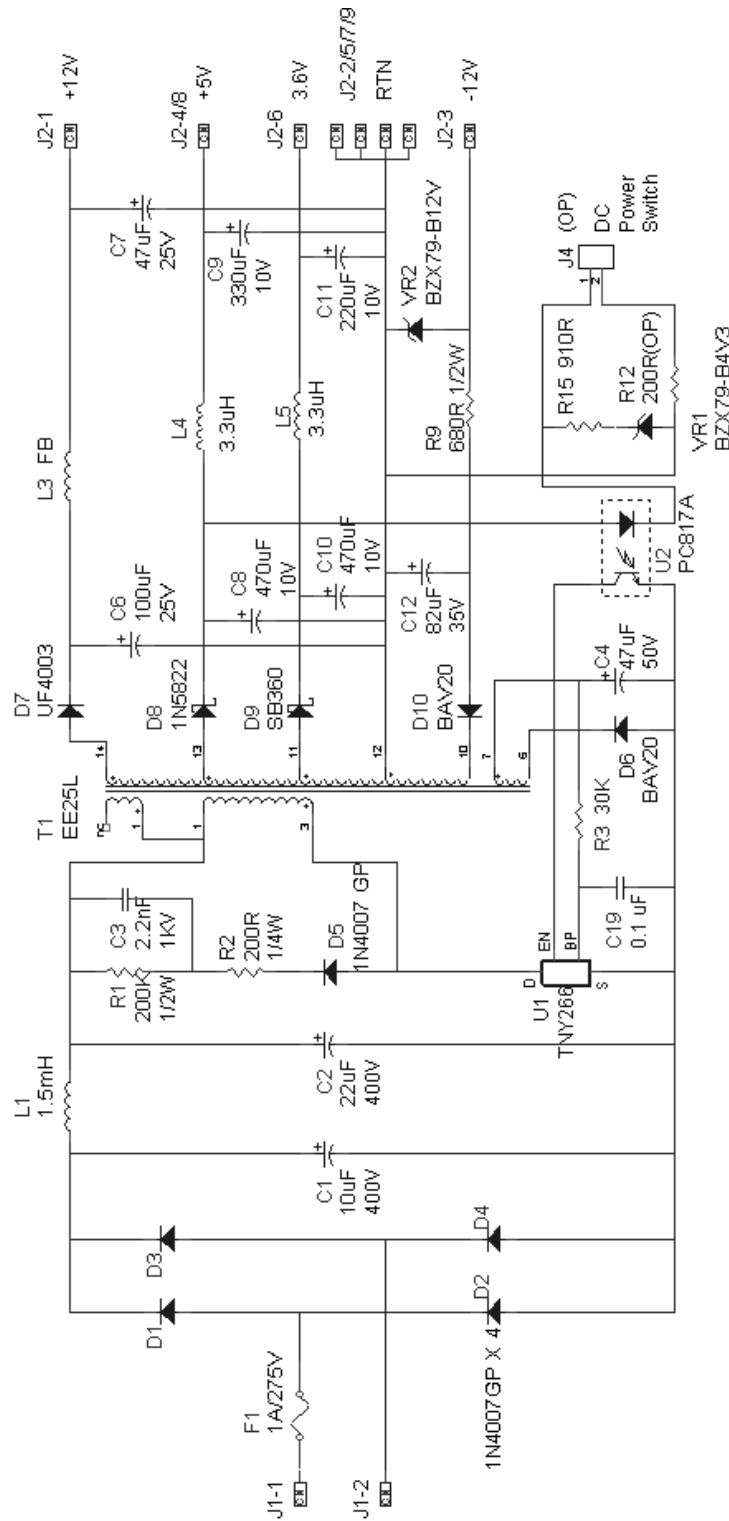

Figure 2 – Schematic.



5 Circuit Description

5.1 Input EMI Filtering

C1, and C2 are the bulk capacitors. Together with L1, they form the EMI filter. TinySwitch-II's built-in frequency jitter helps achieve low EMI in spite of this very simple EMI filter.

5.2 Primary Clamp Snubber

D5, R1, R2, and C3 form the primary clamp snubber to clamp the voltage spike at the Drain pin after turn-off. D5 is a 1N4007G, a glass-passivated version of the standard 1N4007, with controlled reverse recovery. Its use, along with R2, improves EMI and efficiency.

5.3 Output filtering

C6, C8, and C12 are the main output capacitors. C7, C9, and C11, along with L3, L4, and L5, form second-stage output filters.

5.4 Output Feedback

U2, VR1, and R15 form the voltage feedback network. The 5V output voltage setpoint is set by the voltage drops of U2, VR1, and R15. The TinySwitch-II unique feedback scheme, with constant feedback current over line and load changes, means that the current in the zener does not change, thus the voltage drops in U2, VR1, and R15 do not change. This yields tight regulation in spite of the circuit's simplicity and low cost.

5.5 "DC Switch"

J4 is connected to a switch, wherein if it is closed, the 5V output drops to about 1.2V, because the zener ZR1 is essentially shorted out. All the output drop to about 1/5th of their normal voltages. During this condition, the load draws very little current. Because of the TinySwitch's EcoSmart operation, it draws very little input power - <200 mW. This "DC Switch", can be used in place of a normal "AC Switch" that's used to disconnect the AC power. The DC Switch is lower cost because it does not have to be Safety-rated, and is lower voltage.



6 PCB Layout

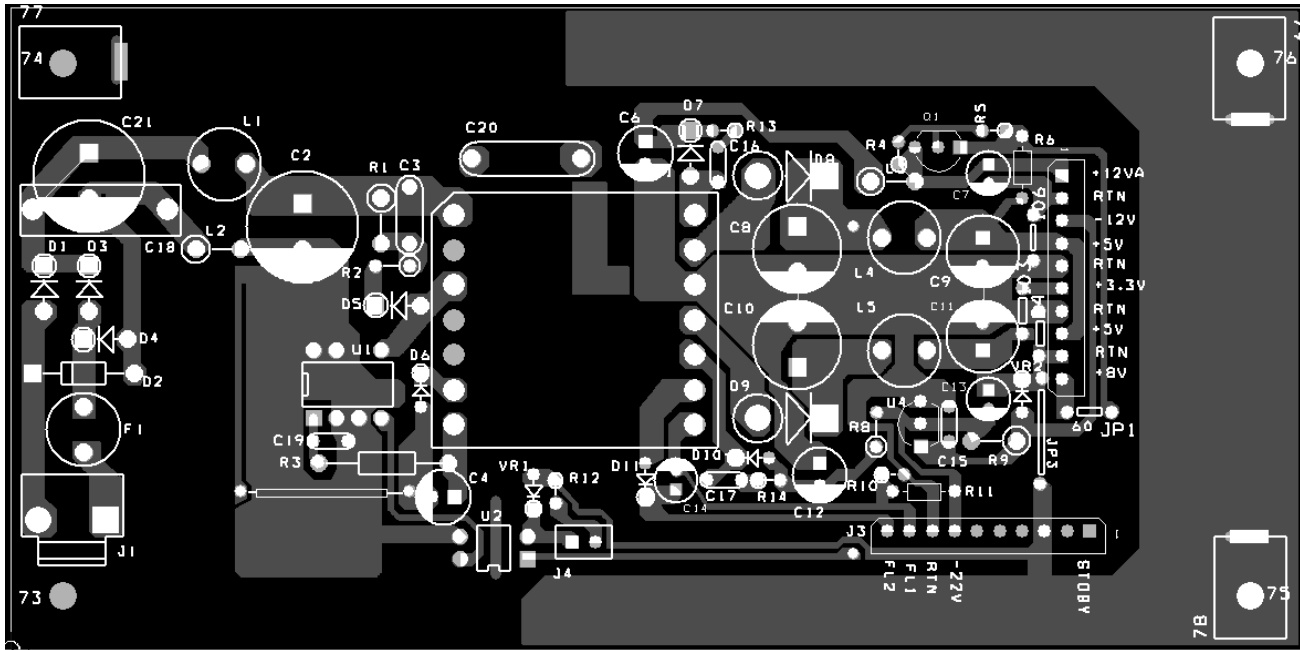

Figure 3 – Printed Circuit Layout.

Note: This is a generic PCB for multiple output supplies of different output configurations. In this application, the following components are not stuffed: C15, C16, C17, C18, C20, L2, Q1, U4, R4, R5, R6, R10, R11, R13, R14. R15 is added in series with VR1 and placed on the top of PCB.



7 Bill Of Materials

Item	Qty	Reference	Description	P/N	Manufacturer
1	1	C1	10 μ F, 400 V	KMG400VB10RM	Nippon Chemi-Con
2	1	C2	22 μ F, 400 V	KMG400VB22RM	Nippon Chemi-Con
3	1	C3	2.2 nF, 1 kV, ceramic Z5U dielectric		Any
4	1	C19	0.1 μ F, 100 V, ceramic Z5U dielectric		Any
5	1	C12	82 μ F, 35 V	KMG35VB82RM	Nippon Chemi-Con
6	1	C6	100 μ F, 25 V, low esr	KZE25VB101M	Nippon Chemi-Con
7	2	C8, C10	470 μ F, 10 V, low esr	KZE10VB471M	Nippon Chemi-Con
8	1	C9	330 μ F, 10 V, low esr	KZE10VB331M	Nippon Chemi-Con
9	1	C11	220 μ F, 10 V, low esr	KZE10VB221M	Nippon Chemi-Con
10	1	C4	47 μ F, 50 V, low esr	KZE50VB47RM	Nippon Chemi-Con
11	1	C7	47 μ F, 25 V, low esr	KZE25VB47RM	Nippon Chemi-Con
12	4	D1, D2, D3, D4	1 A, 1000 V, Glass Passivated	1N4007GP	Any
13	1	D5	1 A, 1000 V, Glass Passivated	1N4007GP	Vishay / Any
14	2	D6, D10	BAV20		Any
15	1	D7	UF4003, 200V		Any
16	1	D8	IN5822		Any
17	1	D9	SB360		Any
18	1	F1	1A/275V Fuse		Any
19	1	L1	1.5 mH, 0.25 A		Any
20	1	L3	Ferrite Bead		Any
21	2	L4, L5	3.3 μ H, 1 A		Any
22	1	R1	200 K Ω , 1/2 W, 5%		Any
23	2	R2, R12	200 Ω , 1/4 W, 5%		Any
24	1	R3	30 k Ω , 1/4 W, 5%		Any
25	1	R9	680 Ω , 1/2 W, 5%		Any
26	1	R15	910 Ω , 1/4 W, 5%		Any
27	1	VR1	4.3 V, 1/4 W, 2%	BZX79-B4V3	Any
28	1	VR2	12 V, 1/4 W, 2%	BZX79-B12V	Any
29	1	T1	EEL25	Custom	Any
30	1	U1	<i>TinySwitch-II</i>	TNY266P	Power Integrations
31	1	U2	Opto-coupler	PC817A	Isocom / Any
32	1	J4	DC Switch	Custom	Any
33	1	J1	AC Input Connector	Custom	Any
34	1	J2	DC Output Connector	Custom	Any
35	1	PCB			



8 Transformer Specification

8.1 Electrical Diagram

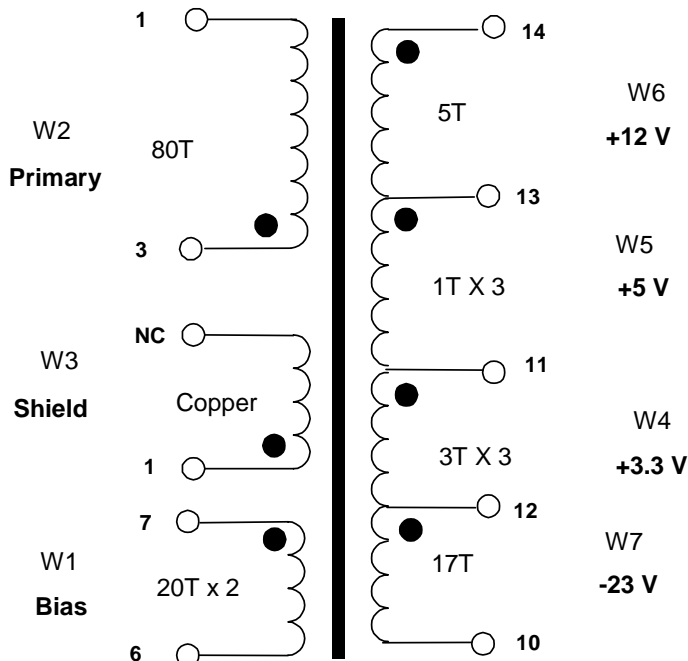

Figure 4 –Transformer Electrical Diagram

8.2 Electrical Specifications

Electrical Strength	1 second, 60 Hz, from Pins 1-7 to Pins 8-14	3000 VAC
Primary Inductance	Pins 1-3, all other windings open, measured at 132 kHz, 0.4 VRMS	1909 μ H, -10/+10%
Resonant Frequency	Pins 1-3, all other windings open	400 kHz (Min.)
Primary Leakage Inductance	Pins 1-3, with Pins 8-14 shorted, measured at 132 kHz, 0.4 VRMS	35 μ H (Max.)

8.3 Materials

Item	Description
[1]	Core: EEL25, TDK Gapped for AL of 298 nH/T ²
[2]	Bobbin: EEL25 Vertical 14 pins
[3]	Magnet Wire: #28 AWG
[4]	Copper Foil 0.12 mm thick, 16 mm wide.
[5]	Tape: 3M 1298 Polyester Film, 16 mm wide
[6]	Tape: 3M 1298 Polyester Film, 22 mm wide
[7]	Margin tape: 3M # 44 Polyester web. 3.0 mm wide



[8]	Teflon
[9]	Copper Tape 2.0 mils thick, 16 mm wide.
[10]	Varnish

8.4 Transformer Build Diagram

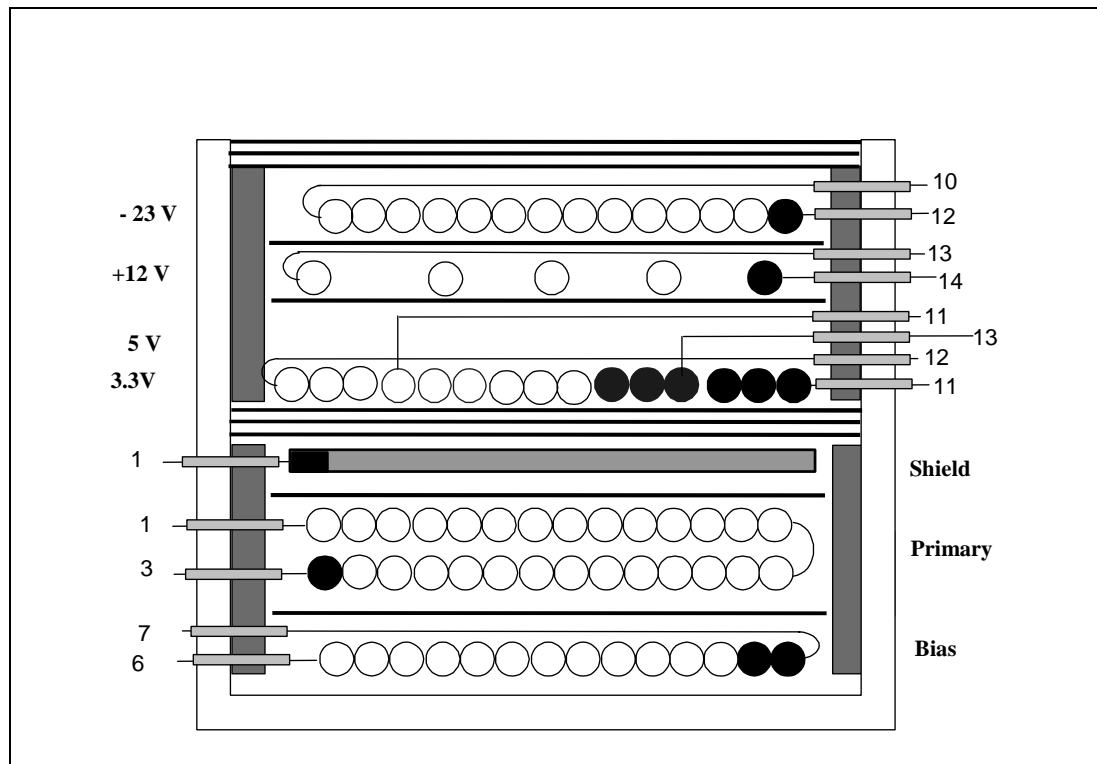

Figure 5 – Transformer Build Diagram.

8.5 Copper Foil Preparation

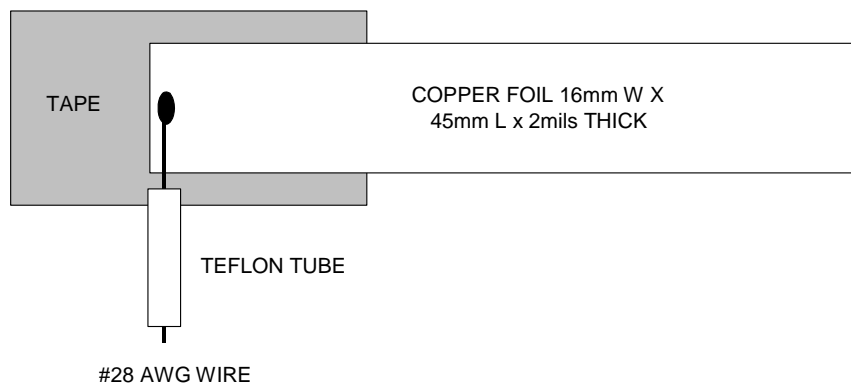

Figure 6 – Foil Winding Preparation Diagram.



8.6 Transformer Construction

Bobbin Set Up Orientation	Set up the bobbin with its pin1 to pin7 oriented to the left hand side.
Margin Tape	Apply 3.0 mm margin at each side of bobbin using item [7]. Match combined height of primary, shield and bias windings.
W1 Bias Winding	Start at pin 8 temporarily. Wind 20 bifilar turns of item [3] from right to left. Wind tightly and uniformly across entire width of bobbin. Finish at pin 6 using item [8] at the finish lead. Flip the starting lead over to pin 7 using item [8] at the finish lead.
Basic Insulation	Apply 1 layer of tape item [5]
W2 Two Layers Primary Winding	Start on pin 3 using item [8] at the start leads. Wind 40 turns of item [3] from left to right. Wind another 40 turns from right to left for second layer. Finish on pin 1 using item [8] at the finish lead.
Basic Insulation	Apply 1 layers of tape item [5]
W3 Copper Shield	Start on pin 1 using item [8] at the start lead. Wind 1 turns of copper shield shown in figure 5. Apply next step tape item[6] first before close this winding to avoid copper shortage.
Basic Insulation	Apply 3 layer (including the tape covering the foil) of tape item [6]
Margin Tape	Apply 3.0 mm margin at each side of bobbin using item [7]. Match combines height of secondary windings.
W4 3.3 V Winding.	Start at pin 11 using item [8] at the start leads. Wind 3 trifilar turns of item [3]. The wires should be tightly and uniformly wound spread across the bobbin width. Finish on pin 12 using item [8] at the finish leads.
W5 +5V Winding	Start on pin 13 using item [8] at the start leads. Wind 1 trifilar turn of item [3]. Wind the wire spread across the bobbin width. Finish on pin 11 using item [8] at the finish leads.
Basic Insulation	Apply one layer of tape item [5]
W6 +12 Winding	Start at pin 14 using item [8] at the start lead. Wind 5 turns of item [3]. Wind uniformly spread across the bobbin. Finish at pin 13 using item [8] at the finish lead.
Basic Insulation	Apply one layer of tape item [5]
W7 -23 V Winding	Start at pin 12 using item [8] at the start leads Wind 17 turns of item [3]. Wind from right to left in a uniform and tightly wound spread across the bobbin width. Finish on pin 10 using item [8] at the finish lead.
Outer Insulation	3 Layers of tape [6] for insulation.
Core Assembly	Assemble and secure core halves. Item [1]
Final Varnish	Dip varnish uniformly in item [10]



9 Transformer Spreadsheets

ACDC_TNY-II_Rev1_1_032701 Copyright Power Integrations Inc. 2001	INPUT	INFO	OUTPUT	UNIT	ACDC_TNYII_Rev1_1_032701.xls: TinySwitch-II Continuous/Discontinuous Flyback Transformer Design Spreadsheet
ENTER APPLICATION VARIABLES					Customer
VACMIN	90			Volts	Minimum AC Input Voltage
VACMAX	265			Volts	Maximum AC Input Voltage
fL	50			Hertz	AC Mains Frequency
VO	5			Volts	Output Voltage
PO	8.55			Watts	Output Power
n	0.73				Efficiency Estimate
Z	0.5				Loss Allocation Factor
tC	3			mSec ds	Bridge Rectifier Conduction Time Estimate
CIN	20			uFarads	Input Filter Capacitor
ENTER TinySwitch-II VARIABLES					
TNY-II	TNY266			<i>Universal</i>	<i>115 Doubled/230V</i>
<i>Chosen Device</i>		<i>TNY266</i>	<i>Power Out</i>	<i>9.5W</i>	<i>15W</i>
ILIMITMIN			0.325	Amps	TINYSwitch Minimum Current Limit
ILIMITMAX			0.375	Amps	TINYSwitch Maximum Current Limit
fS			132000	Hertz	TINYSwitch Switching Frequency
fSmin			120000	Hertz	TINYSwitch Minimum Switching Frequency (inc. jitter)
fSmax			144000	Hertz	TINYSwitch Maximum Switching Frequency (inc. jitter)
VOR	110			Volts	Reflected Output Voltage
VDS	7.9			Volts	TINYSwitch on-state Drain to Source Voltage
VD	0.5			Volts	Output Winding Diode Forward Voltage Drop
KP			0.60		!!!! INCREASE KP > 0.6 (Increase VOR, Larger input capacitor, Larger TinySwitch)
ENTER TRANSFORMER CORE/CONSTRUCTION VARIABLES					
Core Type	eel25				
<i>Core</i>		<i>EEL25</i>		<i>P/N:</i>	<i>PC40EE25.4/32/6.4-Z</i>
<i>Bobbin</i>		<i>EEL25_BOBBIN</i>		<i>P/N:</i>	<i>*</i>
AE			0.404	cm^2	Core Effective Cross Sectional Area
LE			7.34	cm	Core Effective Path Length
AL			1420	nH/T^2	Ungapped Core Effective Inductance
BW			22.3	mm	Bobbin Physical Winding Width
M	3			mm	Safety Margin Width (Half the Primary to Secondary Creepage Distance)
L	1				Number of Primary Layers
NS	4				Number of Secondary Turns
DC INPUT VOLTAGE PARAMETERS					



VMIN			89	Volts	Minimum DC Input Voltage
VMAX			375	Volts	Maximum DC Input Voltage
CURRENT WAVEFORM SHAPE PARAMETERS					
DMAX			0.57		Maximum Duty Cycle
IAVG			0.13	Amps	Average Primary Current
IP			0.33	Amps	Minimum Peak Primary Current
IR			0.19	Amps	Primary Ripple Current
IRMS			0.18	Amps	Primary RMS Current
TRANSFORMER PRIMARY DESIGN PARAMETERS					
LP			1909	uHenries	Primary Inductance
NP			80		Primary Winding Number of Turns
ALG			298	nH/T ²	Gapped Core Effective Inductance
BM			2215	Gauss	Flux Density, IP (BP<3000)
BAC			573	Gauss	AC Flux Density for Core Loss Curves (0.5 X Peak to Peak)
ur			2053		Relative Permeability of Ungapped Core
LG			0.13	mm	Gap Length (Lg > 0.1 mm)
BWE			16.3	mm	Effective Bobbin Width
OD			0.20	mm	Maximum Primary Wire Diameter including insulation
INS			0.04	mm	Estimated Total Insulation Thickness (= 2 * film thickness)
DIA			0.16	mm	Bare conductor diameter
AWG			35	AWG	Primary Wire Gauge (Rounded to next smaller standard AWG value)
CM			32	Cmils	Bare conductor effective area in circular mils
CMA			180	Cmils/Amp	!!!!!!! INCREASE CMA>200 (increase L(primary layers),decrease NS,larger Core)
TRANSFORMER SECONDARY DESIGN PARAMETERS (SINGLE OUTPUT / SINGLE OUTPUT EQUIVALENT)					
Lumped parameters					
ISP			6.50	Amps	Peak Secondary Current
ISRMS			3.06	Amps	Secondary RMS Current
IO			1.71	Amps	Power Supply Output Current
IRIPPLE			2.54	Amps	Output Capacitor RMS Ripple Current
CMS			613	Cmils	Secondary Bare Conductor minimum circular mils
AWGS			22	AWG	Secondary Wire Gauge (Rounded up to next larger standard AWG value)
DIAS			0.65	mm	Secondary Minimum Bare Conductor Diameter
ODS			4.08	mm	Secondary Maximum Outside Diameter for Triple Insulated Wire
INSS			1.71	mm	Maximum Secondary Insulation Wall Thickness
VOLTAGE STRESS PARAMETERS					
VDRAIN			626	Volts	Maximum Drain Voltage Estimate (Includes Effect of Leakage Inductance)
PIVS			24	Volts	Output Rectifier Maximum Peak Inverse Voltage



TRANSFORMER SECONDARY DESIGN PARAMETERS (MULTIPLE OUTPUTS)				
1st output				
VO1	3.6		Volts	Output Voltage
IO1	0.600		Amps	Output DC Current
PO1		2.16	Watts	Output Power
VD1	0.5		Volts	Output Diode Forward Voltage Drop
NS1		2.98		Output Winding Number of Turns
ISRMS1		1.075	Amps	Output Winding RMS Current
IRIPPLE1		0.89	Amps	Output Capacitor RMS Ripple Current
PIVS1		18	Volts	Output Rectifier Maximum Peak Inverse Voltage
CMS1		215	Cmils	Output Winding Bare Conductor minimum circular mils
AWGS1		26	AWG	Wire Gauge (Rounded up to next larger standard AWG value)
DIAS1		0.41	mm	Minimum Bare Conductor Diameter
ODS1		5.47	mm	Maximum Outside Diameter for Triple Insulated Wire
2nd output				
VO2	12.0		Volts	Output Voltage
IO2	0.100		Amps	Output DC Current
PO2		1.20	Watts	Output Power
VD2	0.7		Volts	Output Diode Forward Voltage Drop
NS2		9.24		Output Winding Number of Turns
ISRMS2		0.179	Amps	Output Winding RMS Current
IRIPPLE2		0.15	Amps	Output Capacitor RMS Ripple Current
PIVS2		55	Volts	Output Rectifier Maximum Peak Inverse Voltage
CMS2		36	Cmils	Output Winding Bare Conductor minimum circular mils
AWGS2		34	AWG	Wire Gauge (Rounded up to next larger standard AWG value)
DIAS2		0.16	mm	Minimum Bare Conductor Diameter
ODS2		1.76	mm	Maximum Outside Diameter for Triple Insulated Wire
3rd output				
VO3	23.0		Volts	Output Voltage
IO3	0.100		Amps	Output DC Current
PO3		2.30	Watts	Output Power
VD3	0.7		Volts	Output Diode Forward Voltage Drop
NS3		17.24		Output Winding Number of Turns
ISRMS3		0.179	Amps	Output Winding RMS Current
IRIPPLE3		0.15	Amps	Output Capacitor RMS Ripple Current
PIVS3		104	Volts	Output Rectifier Maximum Peak Inverse Voltage
CMS3		36	Cmils	Output Winding Bare Conductor minimum circular mils
AWGS3		34	AWG	Wire Gauge (Rounded up to next larger standard AWG value)
DIAS3		0.16	mm	Minimum Bare Conductor Diameter
ODS3		0.95	mm	Maximum Outside Diameter for Triple Insulated Wire



10 Performance Data

All measurements performed at room temperature, 60 Hz input frequency.

10.1 Standby Input Power during DC switch off operation

Note that less than 200mW “DC Switch” power consumption is possible with TinySwitch-II because of its EcoSmart features.

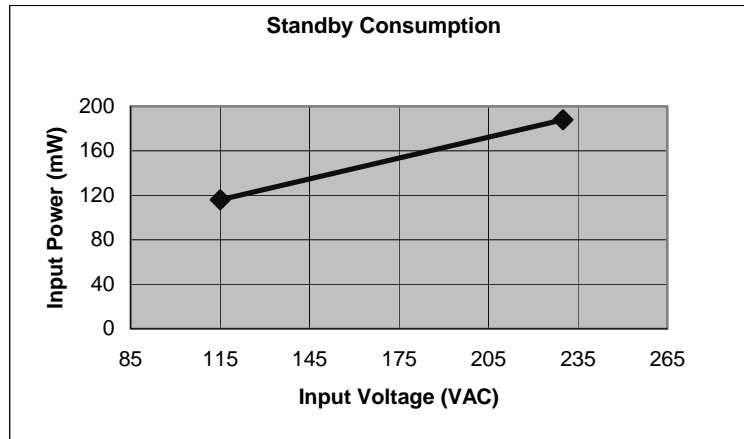

Figure 7- Standby Input Power vs. Input Line Voltage

10.2 Full-load Efficiency

Efficiency at 115 Vac, with continuous load drawn by DVD player during playback.

PI unit: **71%**

10.3 Input Power Consumption during Standby

“Standby” is achieved by turning off the unit using the remote control, with no DVD in the tray.

PI unit: **4.8W**



10.4 Cross Regulation

Minimum and Maximum output voltages were recorded for each output, while cycling the unit on/off, start/stop, pause/run, chapter jump, and fast forward/rewind. The test was done at room temperature, 90 Vac, 115 VAC 132 Vac, 180 Vac, 230 Vac, 265 Vac input. Note the tight regulation of the PI 3.6V output in spite of the low-cost, simple Zener regulation. This is possible with TinySwitch-II because of its unique feedback scheme.

Output	Minimum	Maximum	Tolerance
3.6 V	3.644	3.848	+6.89 / +1.22%
5 V	4.96	5.04	+0.80 / -0.80%
+12 V	11.68	12.56	+4.67 / -2.67%
-12 V	-12.48	-12.40	+4.00 / -3.33%

Thermal Performance

Note: The Power Supply was installed in the DVD player enclosure. The DVD player was playing a DVD. Temperature rise is less than 25 °C

Temperature (°C)		
Item	90 VAC	265VAC
Ambient (Deg.C)	25	25
Transformer (T1)	35	38
TNY266 (U1)	48	53
Rectifier (D8)	38	51

11 Minimum Operating Voltage and Peak Power Margin

The unit is capable of starting and running as low as **60 Vac** in spite of the small total input capacitance of 32uf. This indicates *plenty of margin* for the DVD player's peak power requirements, as flyback power supplies deliver less maximum power when the AC input voltage is low.



12 Output ripple and Noise Waveforms

The ripple and noise were measured during normal DVD operation and switches between different functions at room temperature, 90 VAC input. Note the low output ripple and noise in spite of small output capacitors. The TinySwitch-II shows fast transient response because of its unique feedback scheme.

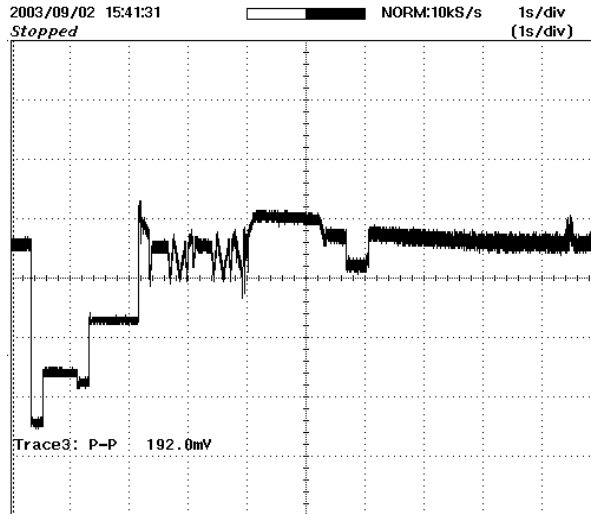

Figure 8 – 3.6V, 1s, 50 mV/div

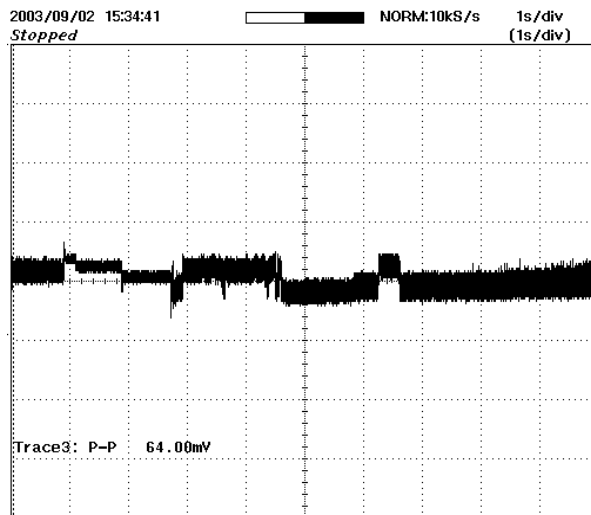

Figure 9 – 5V, 1s, 50 mV/div



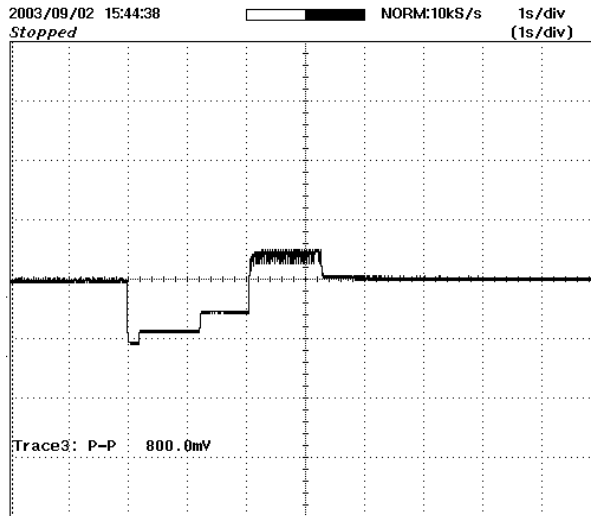

Figure 10 – 12V, 1s, 500 mV/div

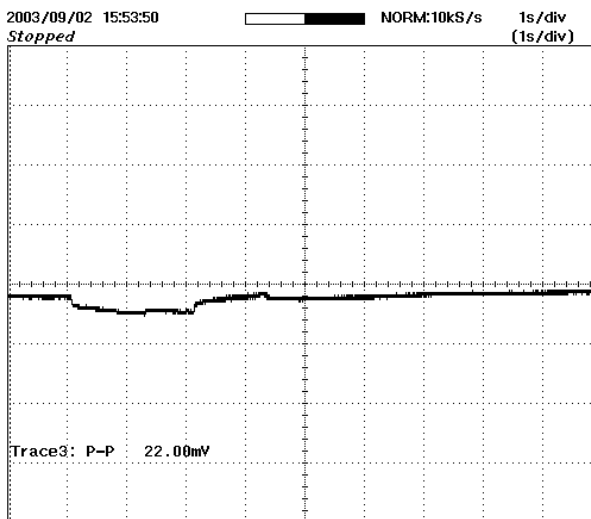

Figure 11 – -12V, 1s, 50 mV/div



13 Conducted EMI

EMI was tested at room temperature, during normal operation, playing a DVD. Note the lower EMI, especially with output grounded, in spite of having no common mode choke, no Y-cap and no X-cap. The excellent EMI is possible with TinySwitch-II because of its built-in frequency jitter. Note that in normal use, the DVD player is connected to the TV, and the TV chassis is grounded through the antenna wire or cable. Therefore the EMI setup that is representative of the actual application is with the output grounded back to the LISN ground plug.

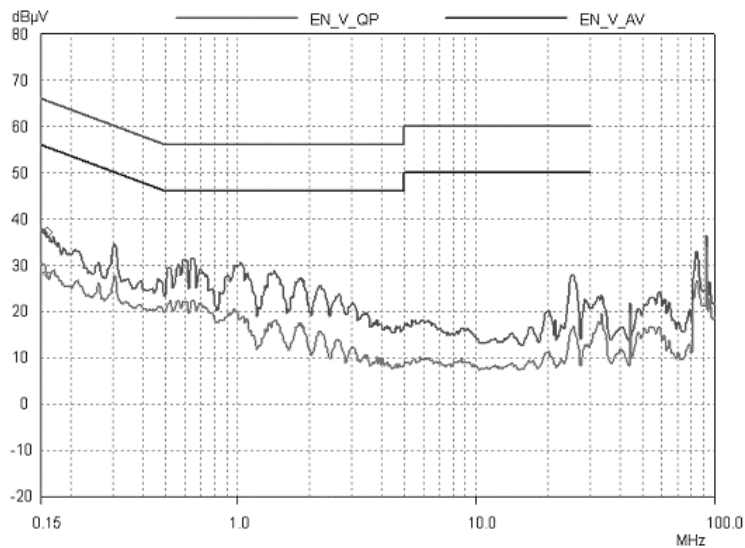

Figure 12 – 230V, Line (worst case), floating output.

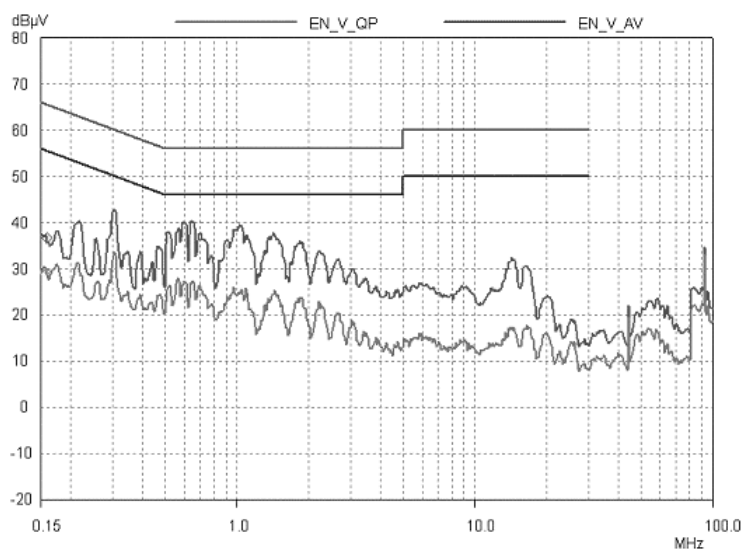

Figure 13 – 230V, Line (worst case), output grounded.



14 Revision History

Date	Author	Revision	Description & changes	Reviewed
February 4, 2004	DZ/JC	1.0	First Release	AM/VC



For the latest updates, visit our Web site: www.powerint.com

Power Integrations reserves the right to make changes to its products at any time to improve reliability or manufacturability. Power Integrations does not assume any liability arising from the use of any device or circuit described herein, nor does it convey any license under its patent rights or the rights of others.

The products and applications illustrated herein (including circuits external to the products and transformer construction) may be covered by one or more U.S. and foreign patents or potentially by pending U.S. and foreign patent applications assigned to Power Integrations. A complete list of Power Integrations' patents may be found at www.powerint.com.

The PI Logo, **TOPSwitch**, **TinySwitch**, **LinkSwitch**, and **EcoSmart** are registered trademarks of Power Integrations, Inc. **PI Expert** and **DPA-Switch** are trademarks of Power Integrations, Inc.
© Copyright 2003, Power Integrations, Inc.

WORLD HEADQUARTERS

NORTH AMERICA - WEST

Power Integrations
5245 Hellyer Avenue
San Jose, CA 95138 USA.
Main: +1-408-414-9200
Customer Service:
Phone: +1-408-414-9665
Fax: +1-408-414-9765
e-mail:
usasales@powerint.com

CHINA

Power Integrations
International Holdings, Inc.
Rm# 1705, Bao Hua Bldg.
1016 Hua Qiang Bei Lu
Shenzhen Guangdong,
518031
Phone: +86-755-8367-5143
Fax: +86-755-8377-9610
e-mail:
chinasales@powerint.com

EUROPE & AFRICA

Power Integrations (Europe) Ltd.
Centennial Court
Easthampstead Road
Bracknell
Berkshire RG12 1YQ,
United Kingdom
Phone: +44-1344-462-300
Fax: +44-1344-311-732
e-mail: eurosales@powerint.com

KOREA

Power Integrations
International Holdings, Inc.
Rm# 402, Handuk Building,
649-4 Yeoksam-Dong,
Kangnam-Gu,
Seoul, Korea
Phone: +82-2-568-7520
Fax: +82-2-568-7474
e-mail: koreasales@powerint.com

SINGAPORE

Power Integrations, Singapore
51 Goldhill Plaza #16-05
Republic of Singapore,
308900
Phone: +65-6358-2160
Fax: +65-6358-2015
e-mail:
singaporesales@powerint.com

JAPAN

Power Integrations, K.K.
Keihin-Tatemono 1st Bldg.
12-20 Shin-Yokohama
2-Chome,
Kohoku-ku, Yokohama-shi,
Kanagawa 222-0033, Japan
Phone: +81-45-471-1021
Fax: +81-45-471-3717
e-mail:
japansales@powerint.com

TAIWAN

Power Integrations
International Holdings, Inc.
17F-3, No. 510
Chung Hsiao E. Rd.,
Sec. 5,
Taipei, Taiwan 110, R.O.C.
Phone: +886-2-2727-1221
Fax: +886-2-2727-1223
e-mail:
taiwansales@powerint.com

INDIA (Technical Support)

Innovatech
#1, 8th Main Road
Vasanthnagar
Bangalore, India 560052
Phone: +91-80-226-6023
Fax: +91-80-228-9727
e-mail:
indiasales@powerint.com

APPLICATIONS HOTLINE

World Wide +1-408-414-9660

APPLICATIONS FAX

World Wide +1-408-414-9760



Power Integrations

Tel: +1 408 414 9200 Fax: +1 408 414 9201
www.powerint.com