

# Erősítő +- 40VDC

120W/4ohm v. 80W/8ohm

## Alkatrész lista

D1	9V1/1,3W
D2,D3	1N4148
R1	120K
R2,R5,R6	3K3
R3	120
R4,R8	680
R7	1K5
R9	5K6
R10	1K2
R11	2K7
R12,R13	270
R14,R15	15
R16,R17	220
R18,R19	1/9W vagy 10W
R20	10
R21,R22	1
C1	470pF
C2	10uF/63V
C3	150pF
C4	1000uF/4V
C5	220uF/40V
C6	47pF
C7,C8	560pF
C9	47nF
C10,C11	680nF
C12,C13	100nF
T1,T2	BC556A
T3,T5	BC548B
T4	BC639
T6	BC558B
T7	TIP142
T8	TIP147

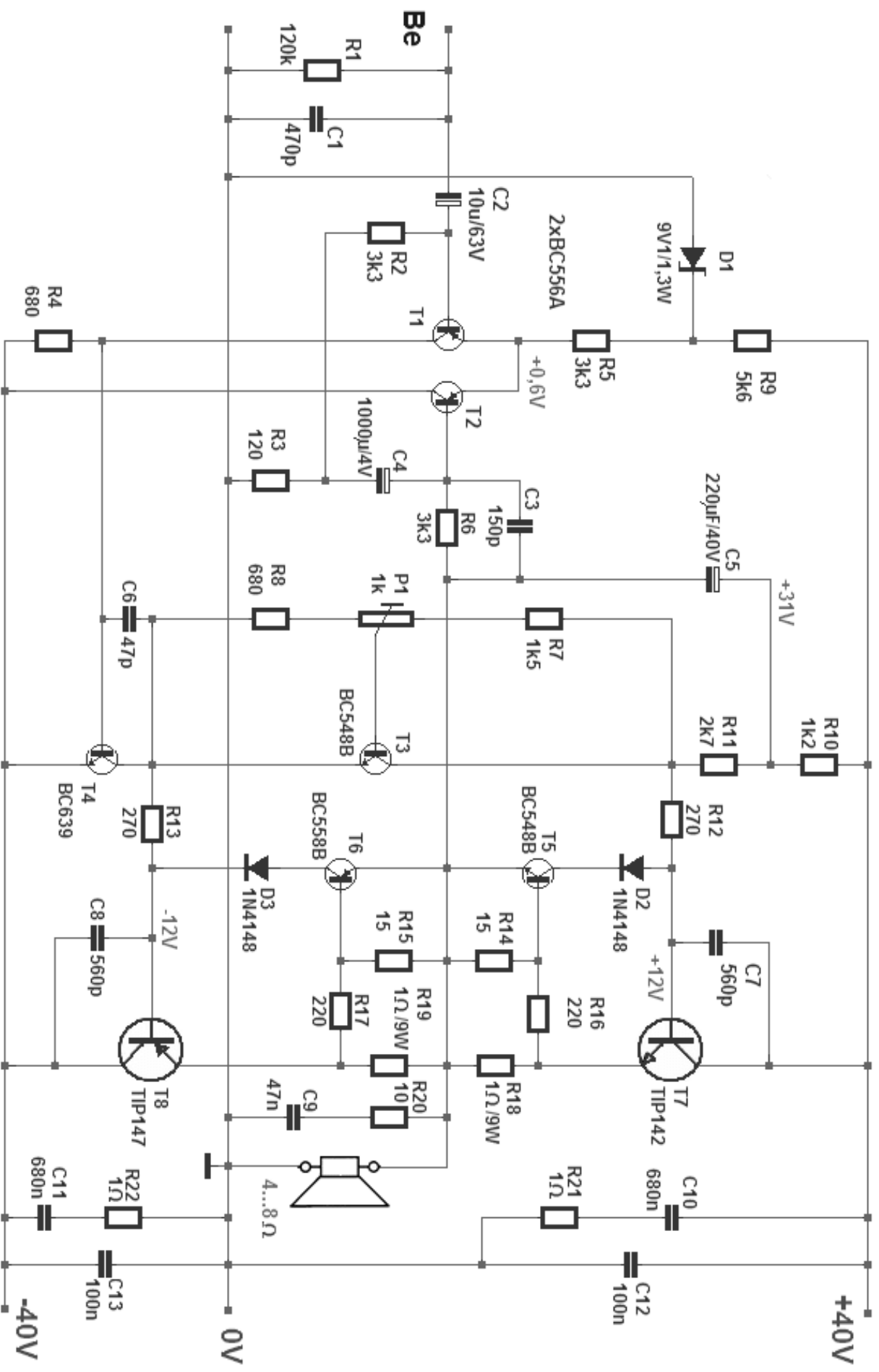

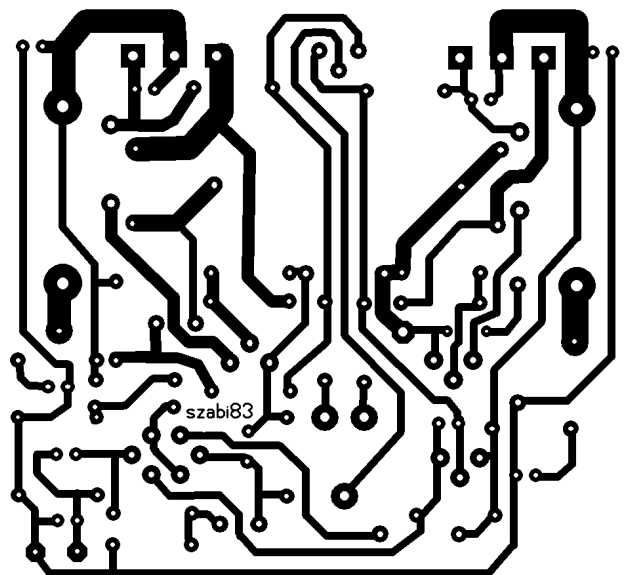
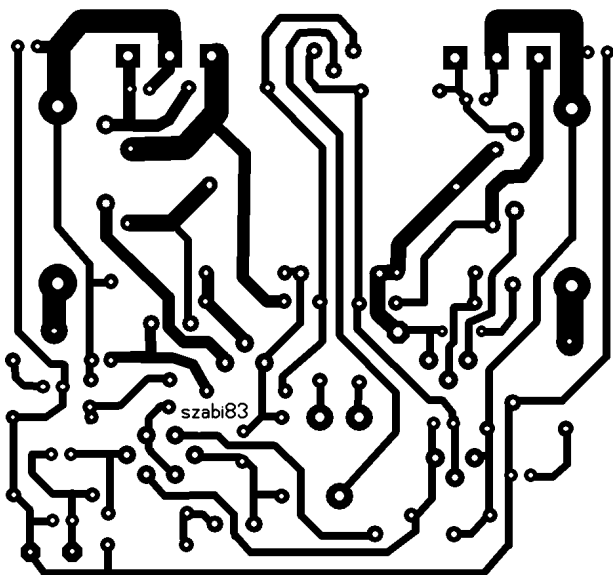
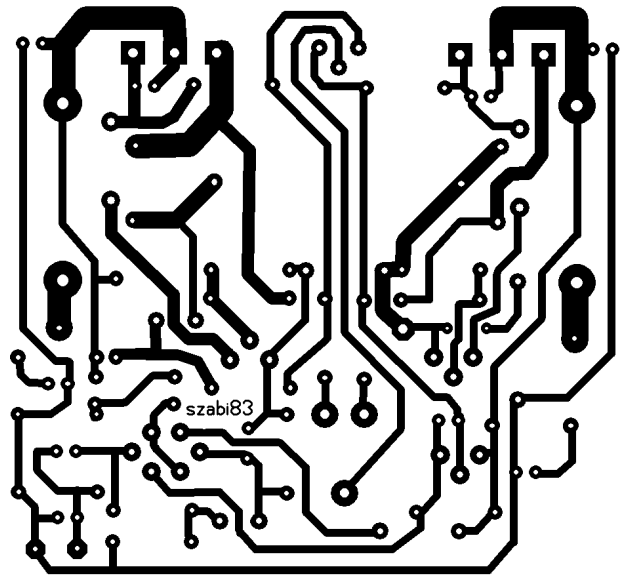
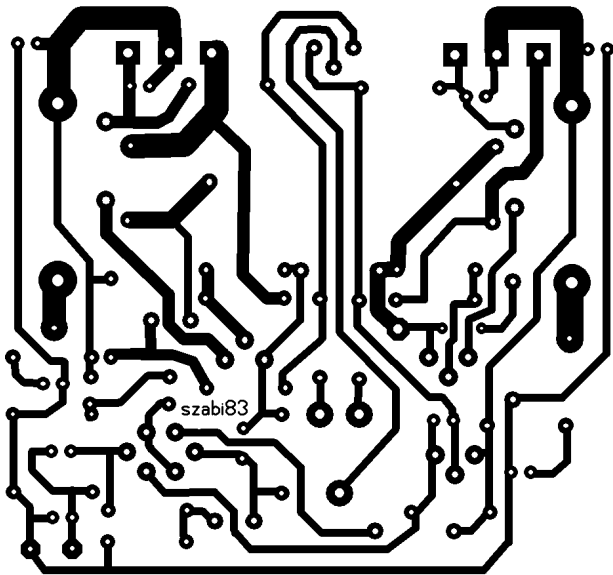
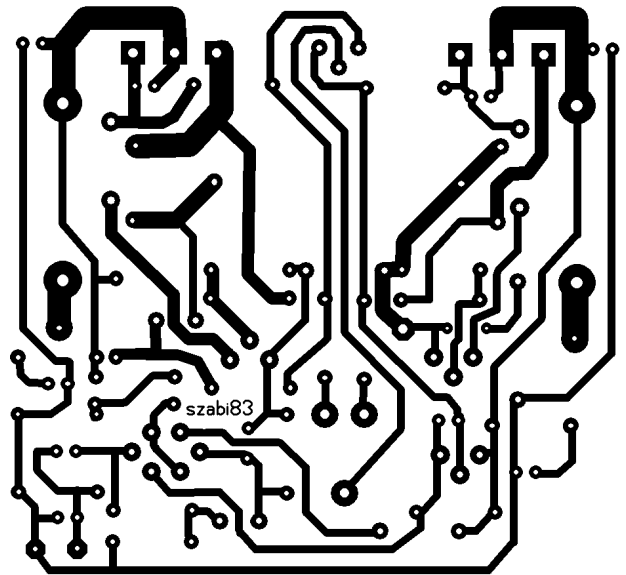
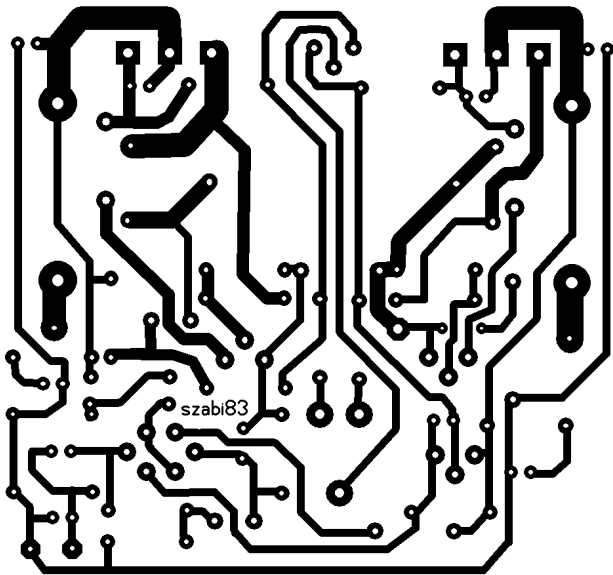

Nyák méret 79mm X 75mm

