

LCD

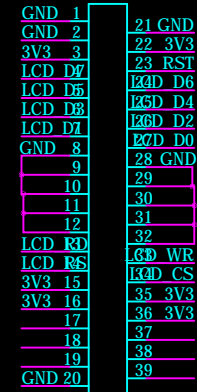

J1

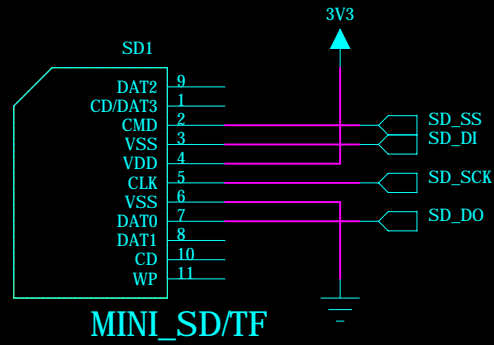
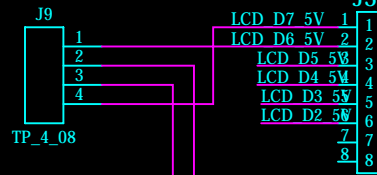
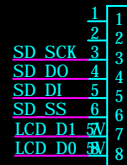
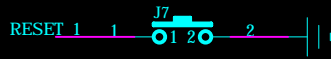

J4

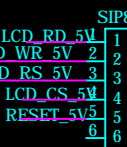

J5

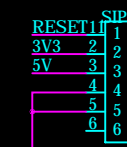

J6

SIP6

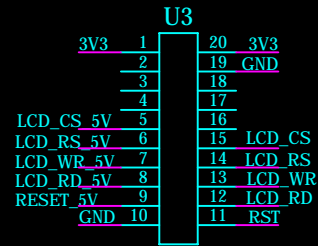
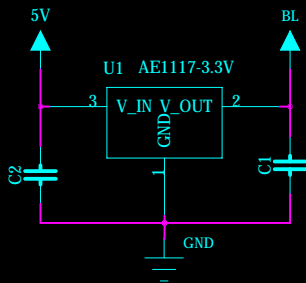

U4

