

Service Manual

Grundig Service

Hotline Deutschland...
...Mo.-Fr. 8.00-18.00 Uhr

Technik:

TV 0180/52318-41
TV 0180/52318-49
SAT 0180/52318-48
VCR/LiveCam 0180/52318-42
HiFi/Audio 0180/52318-43
Car Audio 0180/52318-44
Telekommunikation 0180/52318-45
Fax: 0180/52318-51

Planatron (8.00-22.00 Uhr) 0180/52318-99

Ersatzteil-Verkauf: Mo.-Fr. 8.00-19.00 Uhr

Telefon: 0180/52318-40
Fax: 0180/52318-50

TV

CUC 2003

CUC 2003 H

Greenville 370 SE 3781 TOP

(G.CH 7182)

T 55-840 TOP/SAT

(G.CH 4272 / VNM)

P 37-830 Multi/ICN

(G.CH 3102)

T 51-830 Multi/ICN

(G.CH 3275 / VNM)

T 55-830 Multi/ICN

(G.CH 3372 / VNM)

P 45-830 Multi MegASIS

(G.CH 3552)

T 55-830 Multi MegASIS

(G.CH 4572 / VNM)

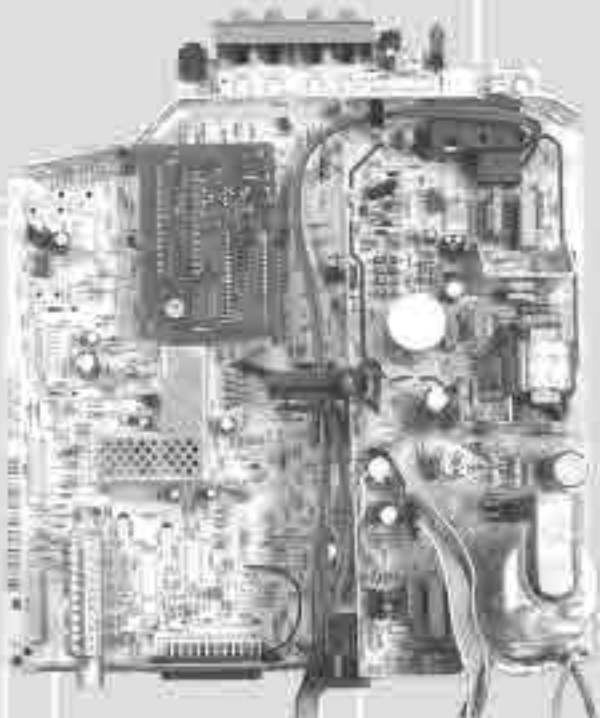

Zusätzlich erforderliche
Unterlagen für den Komplettservice

Additionally required
Service Documents for the Complete Service

Ergänzung
Supplement

1

Materialnr./Part No.
72010 024 0100

**Service
Manual**

**CUC 2003
CUC 2003 H**

Materialnr./Part No.
72010 024 0000

**Service
Manual**

**Sicherheit
Safety**

Materialnr./Part No.
72010 800 0000

**Service
Training**

CUC 2000

Materialnr./Part No.
© 72010 350 3500
© 72010 350 3600

Btx * 32700 #

Materialnummer
Part Number 72010 024 0100

Änderungen vorbehalten
Subject to alteration

Printed in Germany FD
E-BS 33/32 0899
8002/8012, 8003/8013, 8005/8015

<http://www.grundig.de>

Es gelten die Vorschriften und Sicherheitshinweise gemäß dem Service Manual "Sicherheit", Materialnummer 72010 800 0000, sowie zusätzlich die eventuell abweichenden, landesspezifischen Vorschriften!



The regulations and safety instructions shall be valid as provided by the "Safety" Service Manual, part number 72010 800 0000, as well as the respective national deviations.

D

Für die auf der Titelseite aufgeführten Geräte gilt das Service Manual CUC 2003 / H.

Diese Ergänzung dokumentiert die Unterschiede bzw. zusätzlichen Bestückungen der Geräte.

Grundlage für den Service sind:

- Service Manual CUC 2003 / H (Materialnummer 72010 024 0000)
- Service Manual "Sicherheit" (Materialnummer 72010 800 0000)

GB

The Service Manual CUC 2003 / H applies to the colour television receivers specified on the front page.

This Manual describes the differences and the additionally fitted components of the TV receivers.

Basic instructions for servicing are given in the:

- Service Manual CUC 2003 / H (Part number 72010 024 0000)
- Safety Manual (Part number 72010 800 0000)

Inhaltsverzeichnis

	Seite
Asis-Netzteil	3
Chassisplatte	5
Chassisplatte (vergrößert)	9
Teilschaltplan Netzteil	13
Teilschaltplan Ablenkung	15
Teilschaltplan Prozessor	17
Teilschaltplan Tuner/Buchsen	19
Teilschaltplan Video	21
Teilschaltplan Audio	23
Chassisplatte Megasis - 3	25
Ersatzteilliste	28

Table of Contents

	Page
Mains Section Asis	3
Chassis Board	5
Chassis Board (enlarged)	9
Circuit Diagram Mains Section	13
Circuit Diagram Deflection Section	15
Circuit Diagram Processor Section	17
Circuit Diagram Tuner/Socket Section	19
Circuit Diagram Video Section	21
Circuit Diagram Audio	23
Chassis Board Megasis - 3	25
Spare Parts List	28

ASIS-Netzteil / Mains Section ASIS

Achtung!
 Netzteil steht auch nach Ausschalten des Netzschalters primärseitig weiter unter Netzspannung.
Warning!
 When switching off with the mains switch, mains voltage is still applied to the primary side of the mains section.

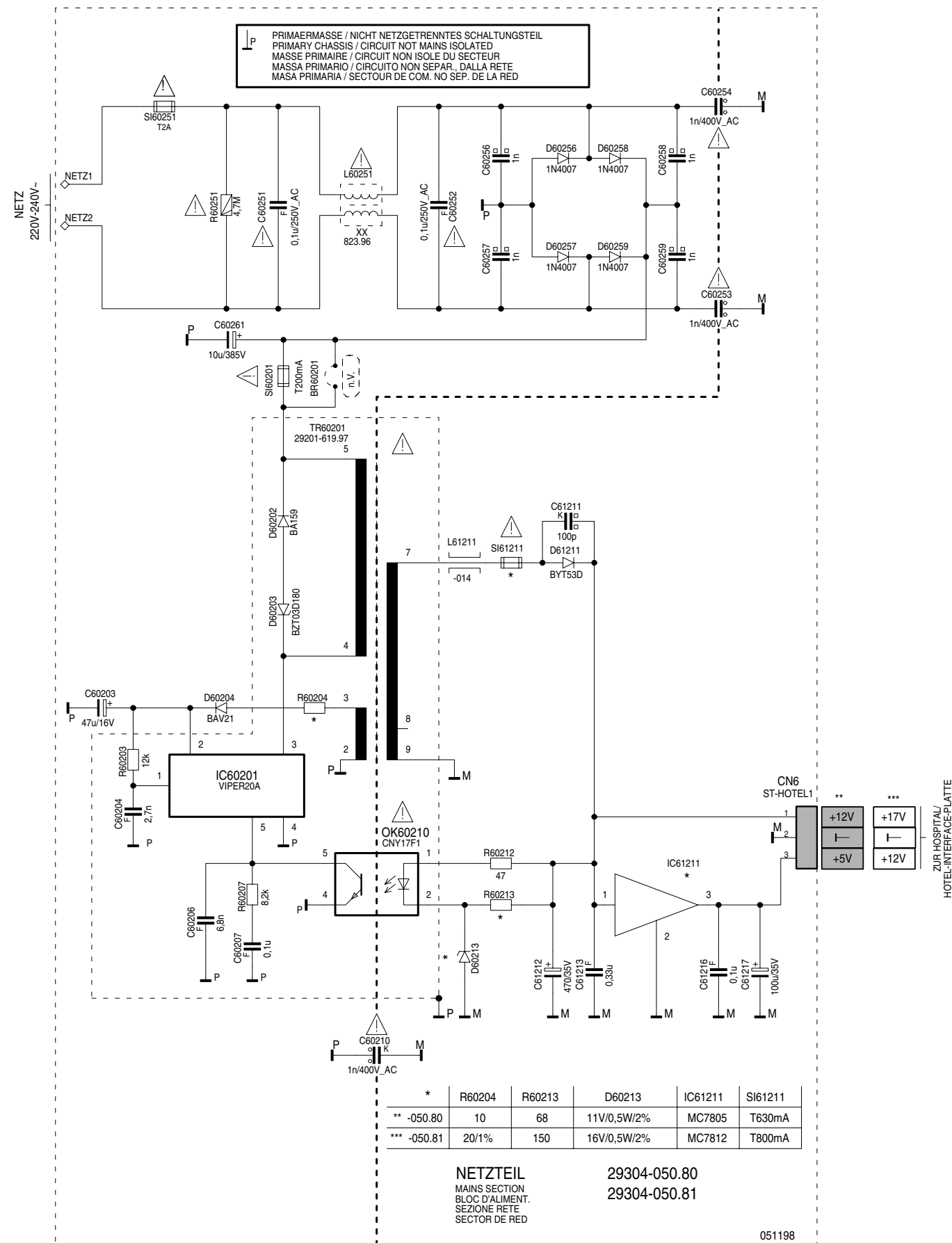

Chassisplatte
Chassis Board

Bestückungsseite, Ansicht von oben
Component Side, Top View

Bildröhre / Picture Tube	+A
37cm ORION	+112V
37cm PHI	+105V
45cm PHI	+124V
51cm SAMSUNG	+124V
55cm PHI	+130V
55cm SAMSUNG	+130V

R60037
+A*

Q34044
NTSC

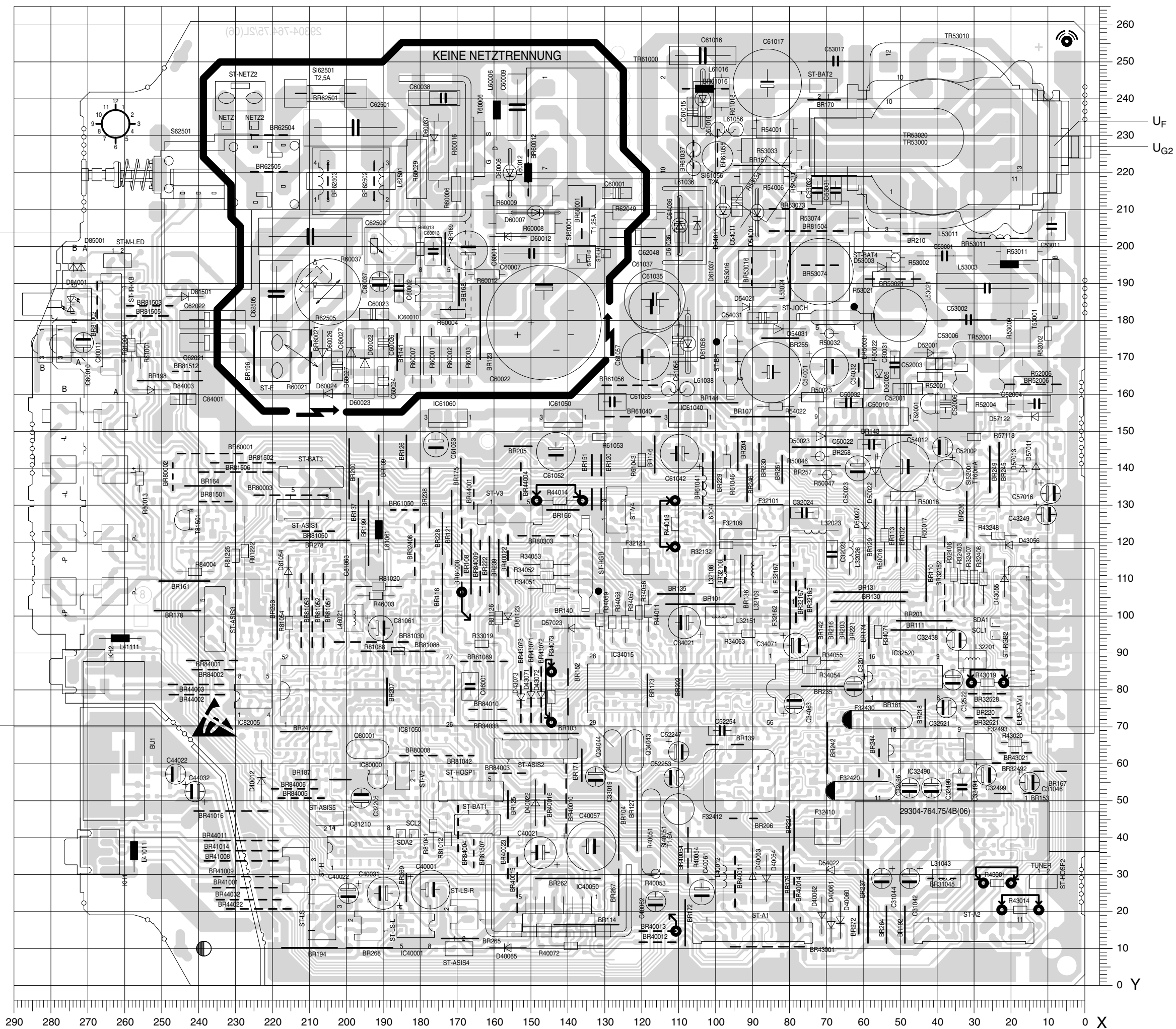

Chassisplatte Chassis Board

Lötseite, Ansicht von unten
Solder Side, Bottom View

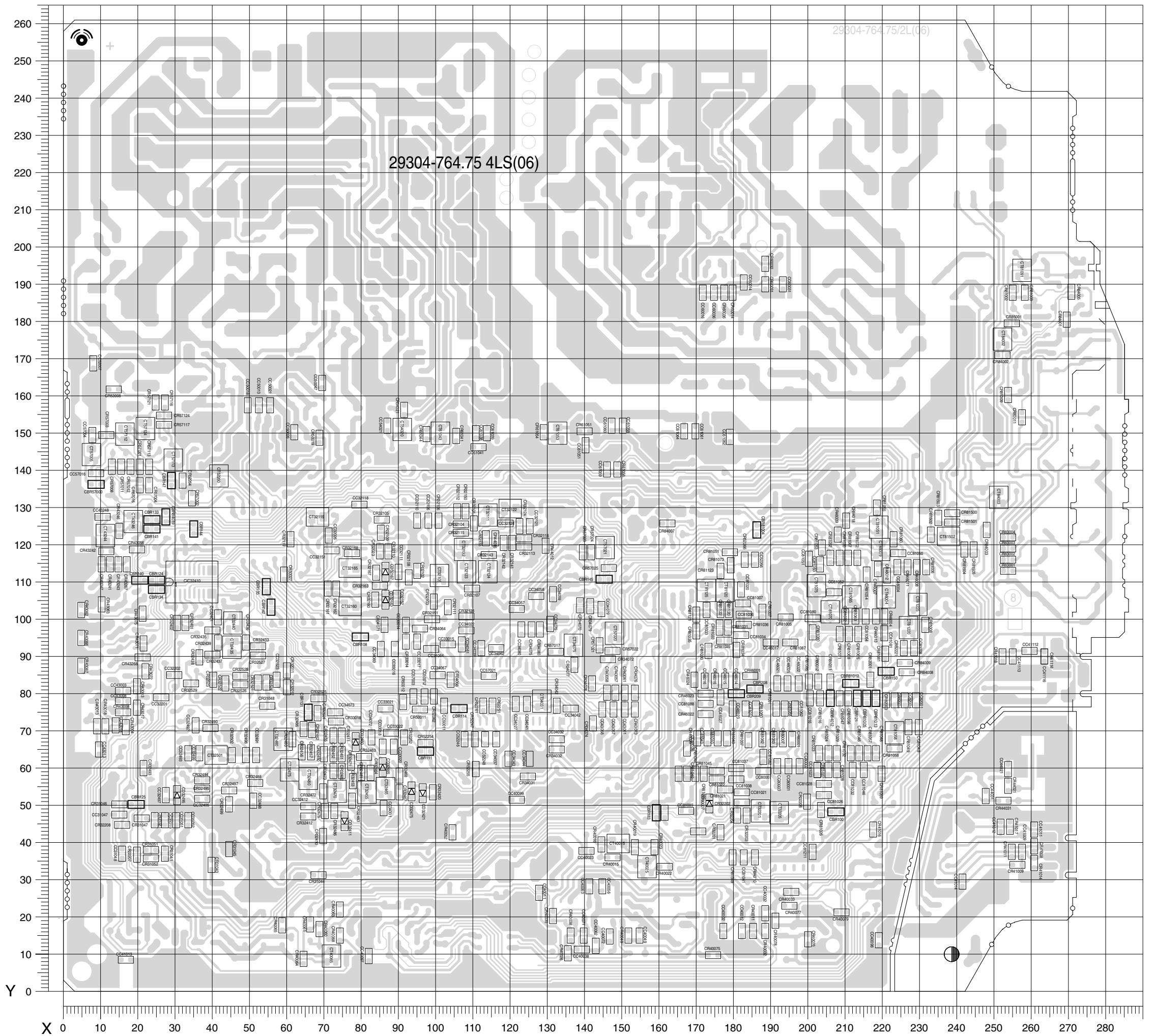

Chassisplatte (vergrößert) Ausschnitt 1
Chassis Board (enlarged) Detail 1

Lötseite, Ansicht von unten
Solder Side, Bottom View

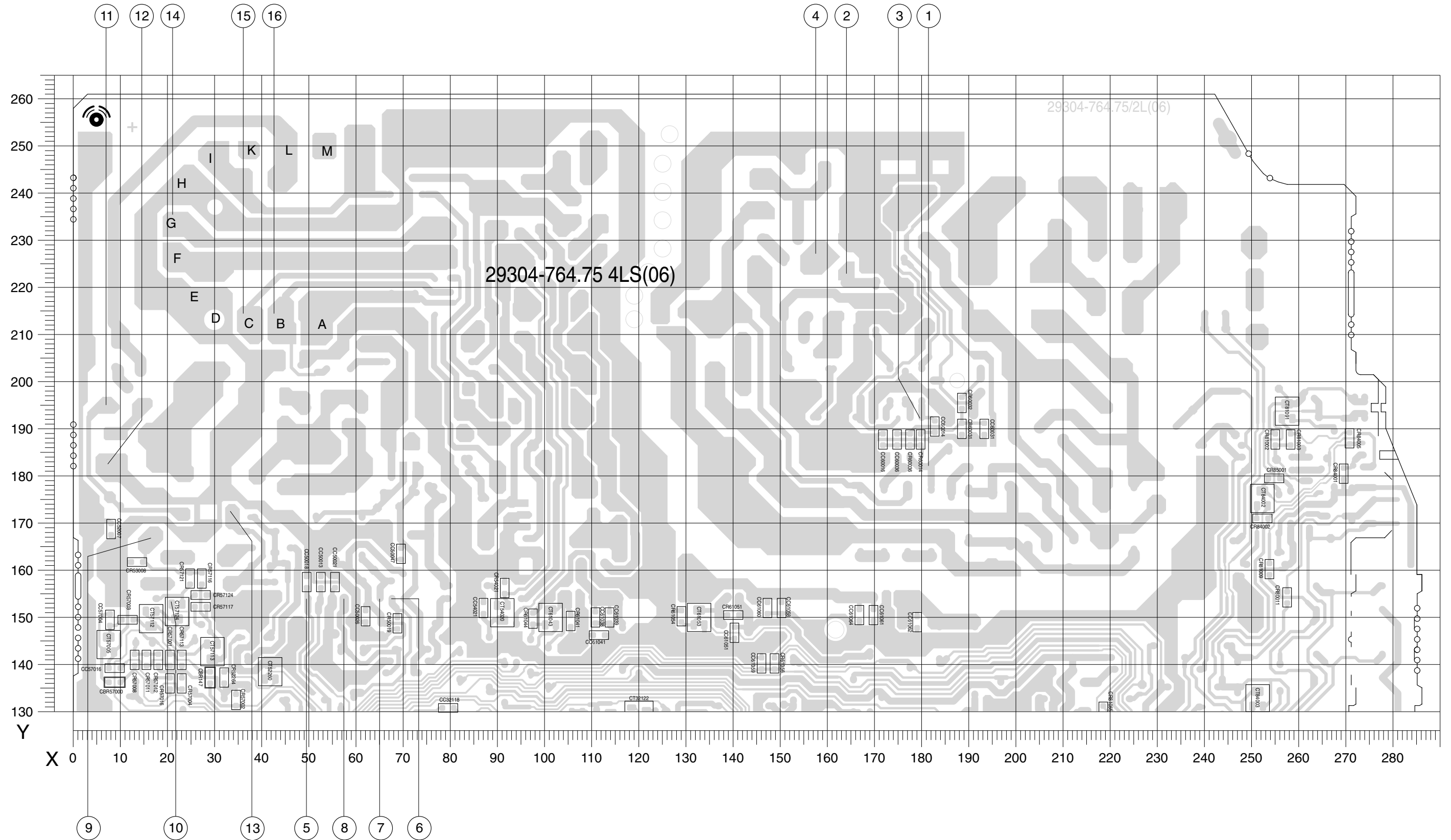

Chassisplatte (vergrößert) Ausschnitt 2
Chassis Board (enlarged) Detail 2

Lötseite, Ansicht von unten
Solder Side, Bottom View

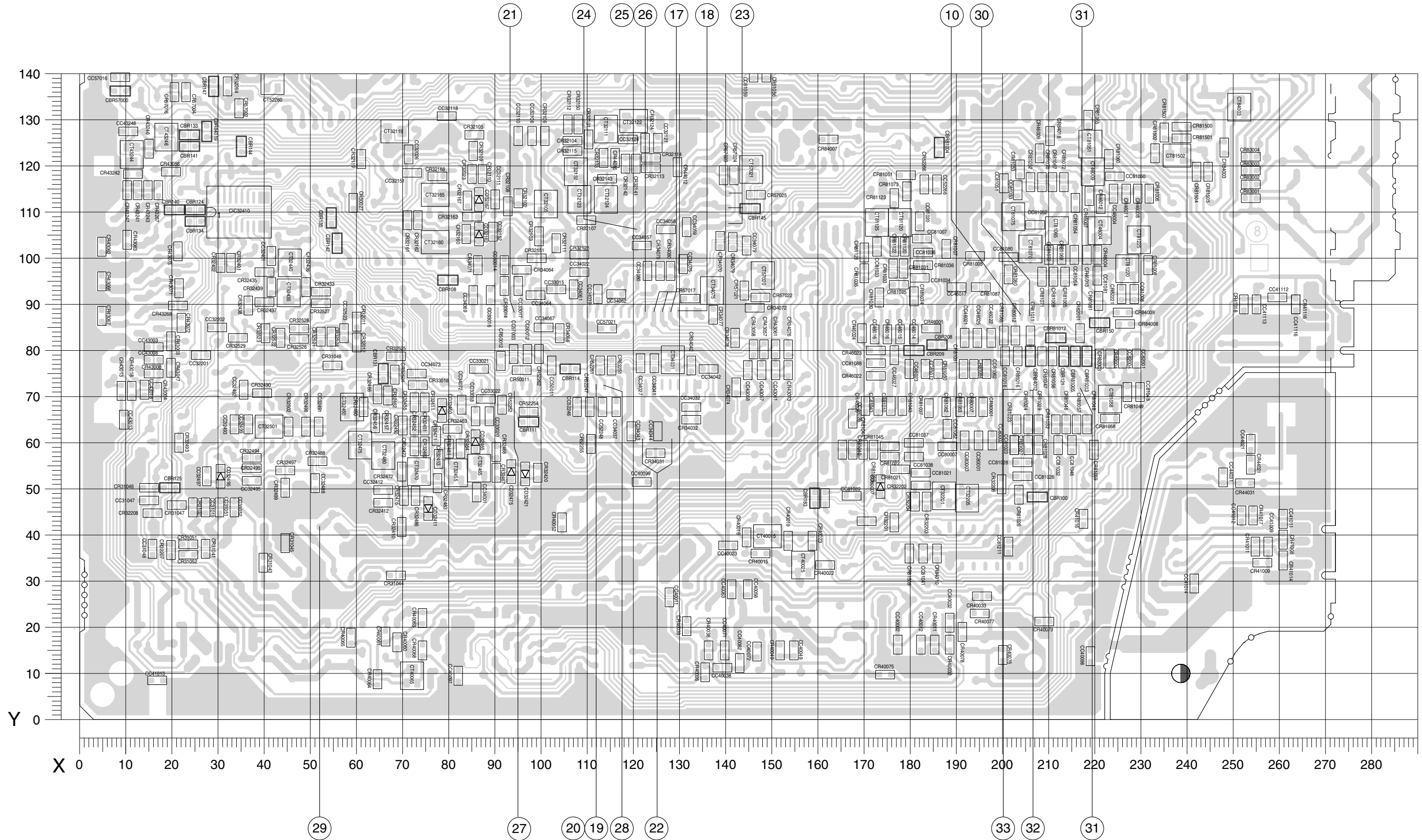

Teilschaltplan Netzteil / Circuit Diagram Mains Section

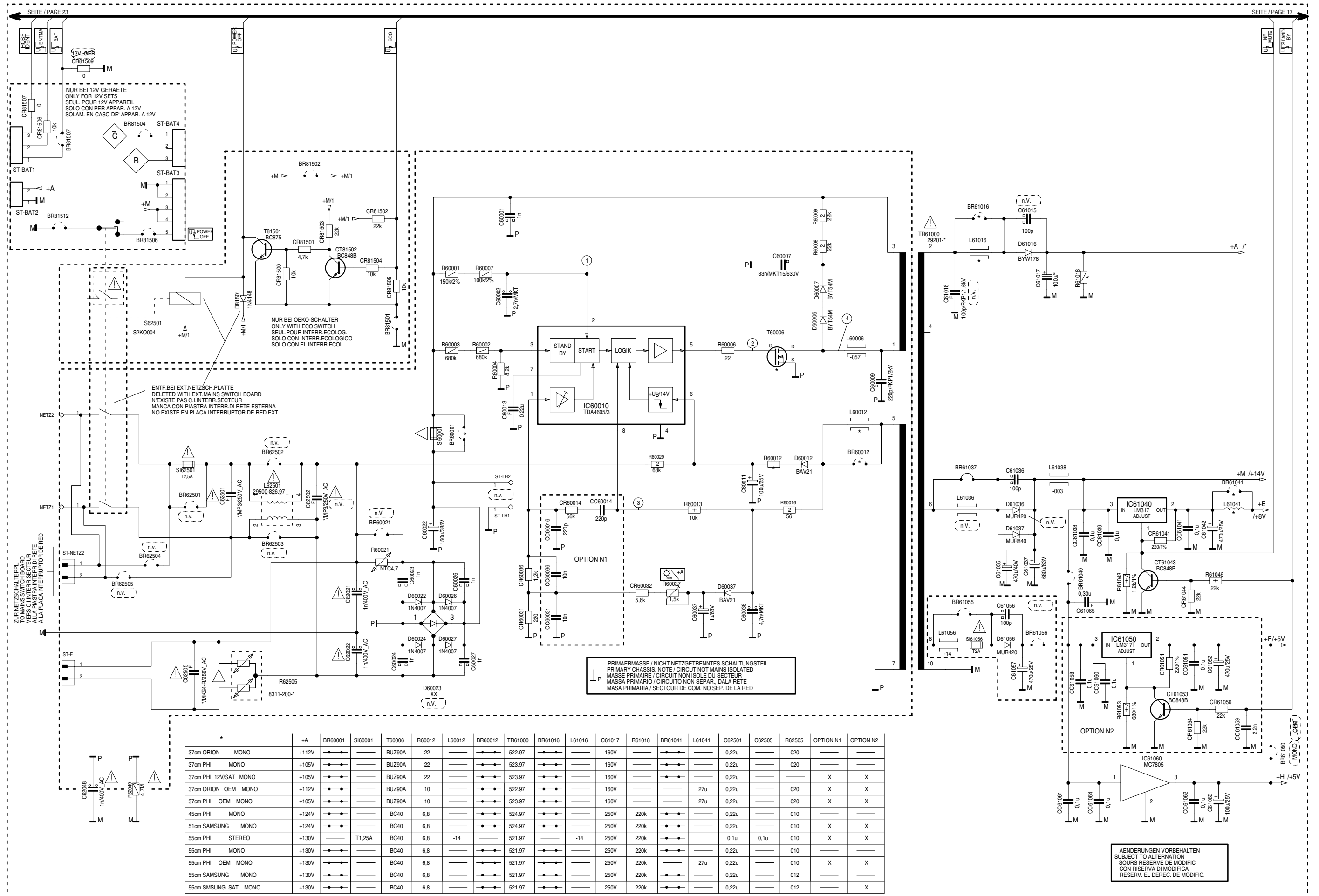

Teilschaltplan Ablenkung / Circuit Diagram Deflection Section

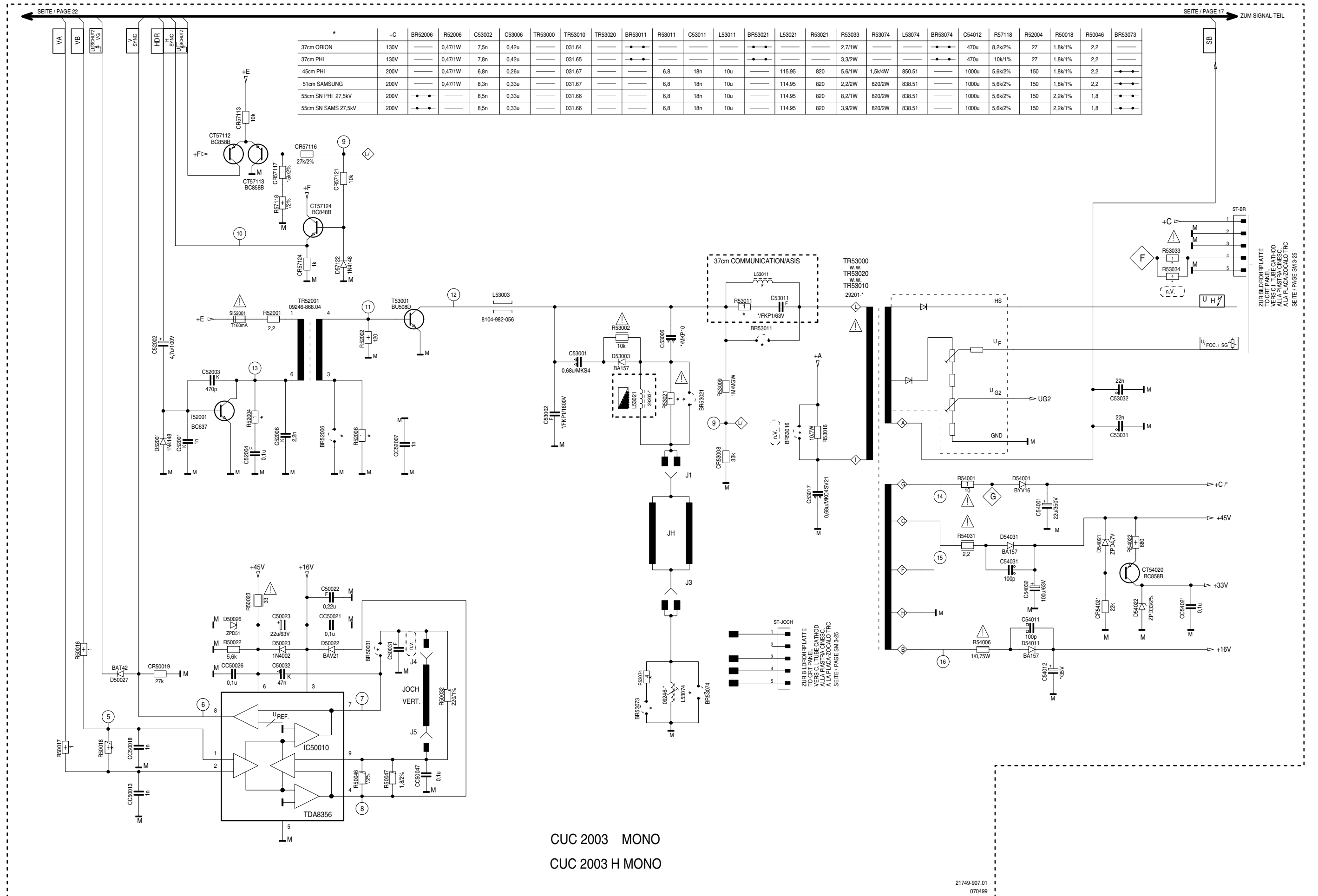

CUC 2003 MONO
CUC 2003 H MONO

Teilschaltplan Prozessor / Circuit Diagram Processor Section

* oder OPTION – siehe Seite 23
* or OPTION – see page 23

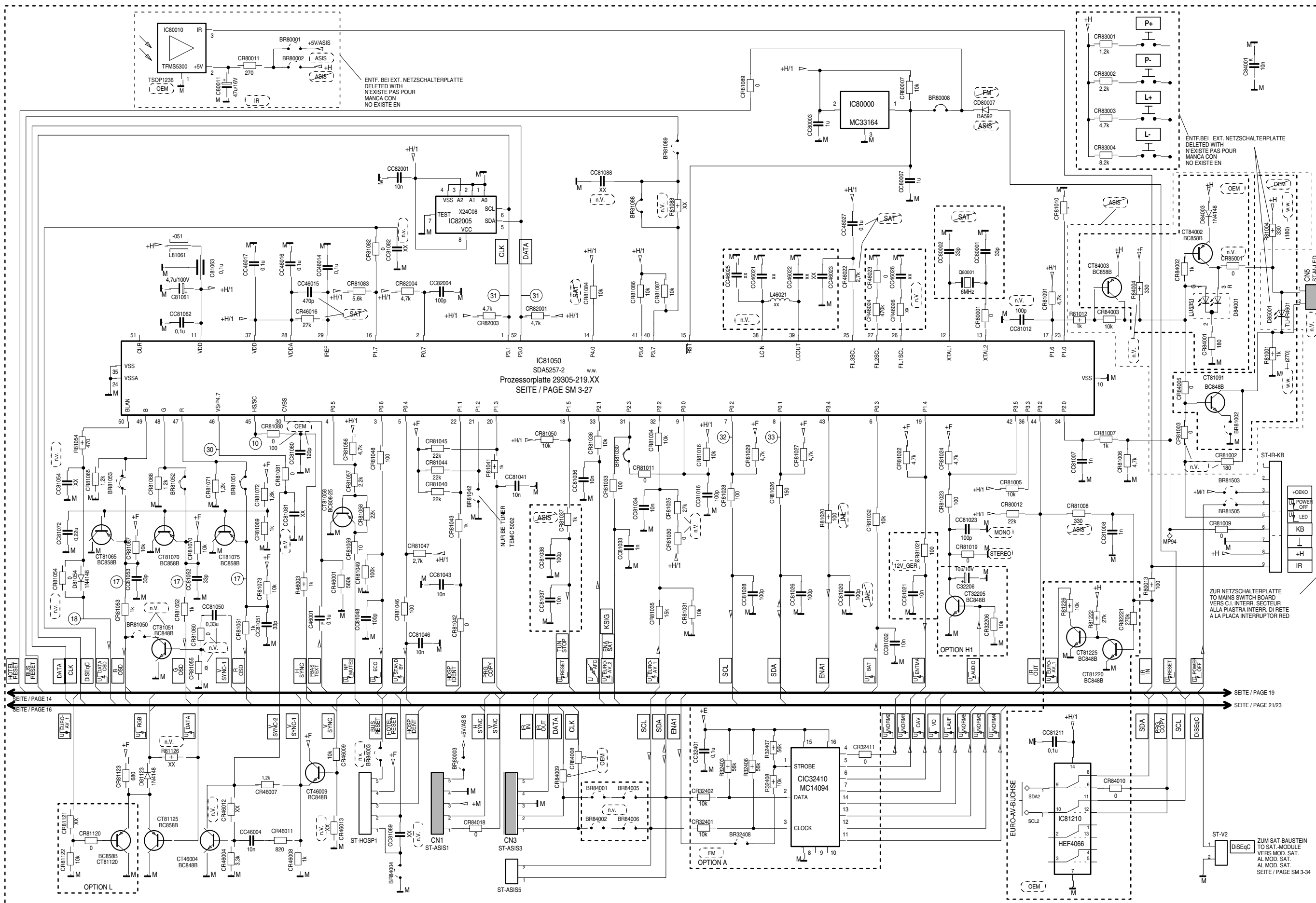

Teilschaltplan Video / Circuit Diagram Video Section

* oder OPTION – siehe Seite 23
* or OPTION – see page 23

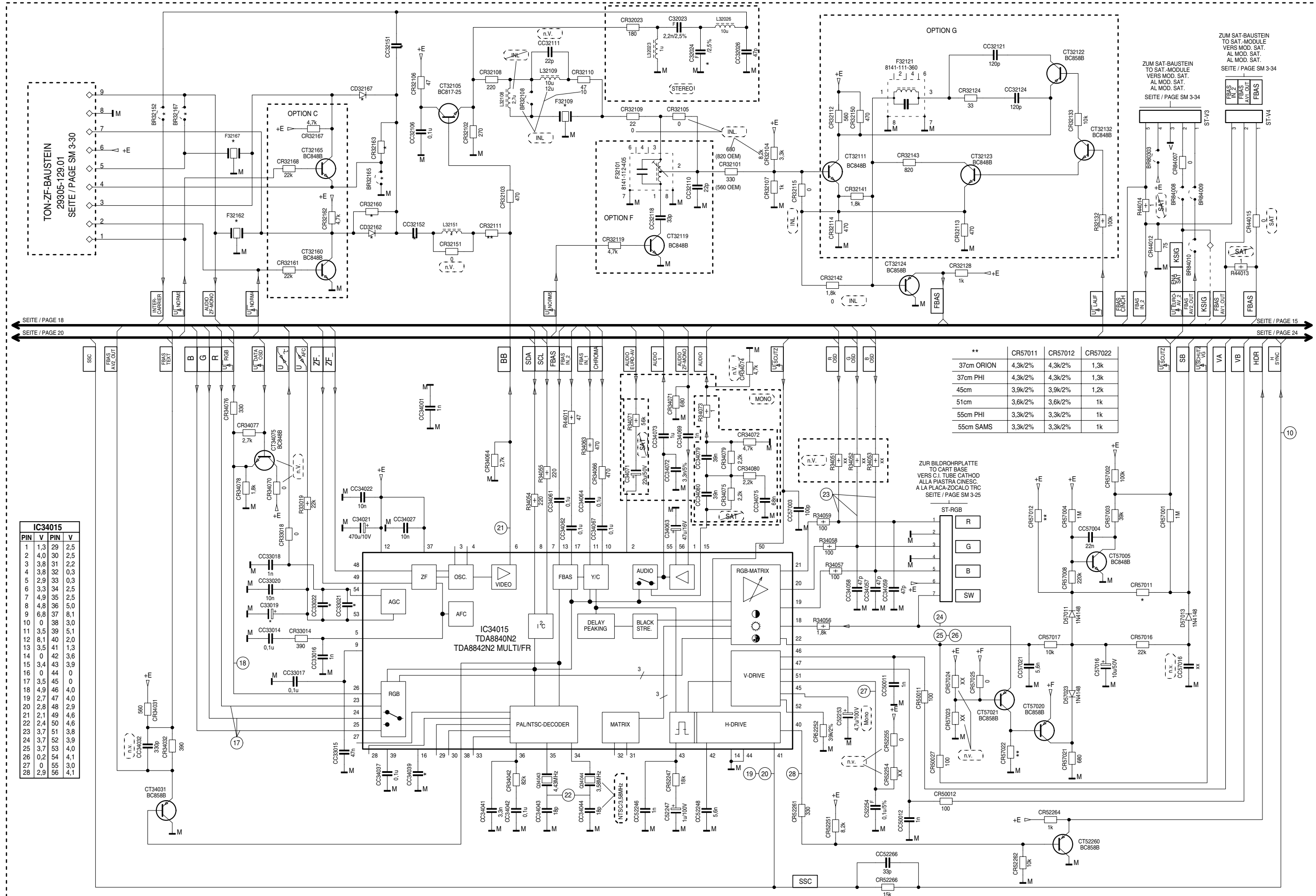

Teilschaltplan Audio / Circuit Diagram Audio

*	INLAND MONO	FR MONO	INLAND STEREO	FR STEREO	MULTI/7 NICAM STEREO	MULTI/7 MONO	MULTI/8 MONO	INLAND MONO/SAT	MULTI/8 MONO/SAT
C31046	10u	22u	10u	22u	10u	22u	10u	22u	22u
CR31046	6,8k	0 OHM	6,8k	0 OHM	6,8k	0 OHM	6,8k	0 OHM	6,8k
C32024	—	—	2,2n	1,5n	2,2n	—	—	2,2n	2,2n
F32109	TPS5,5	TPS6,0	TPS5,5	TPS6,0	TPS6,0	TPS6,0	TPS6,0	TPS5,5	TPS6,0
CR32111	560	1k	—	—	—	560	—	—	—
CC32151	—	—	—	—	—	—	47p	—	—
L32151	27u	27u	—	—	—	22u	—	—	—
CC32152	22p	22p	—	—	—	22p	—	—	—
BR32152	—	—	X	X	X	—	X	X	X
CR32160	0 OHM	—	—	—	—	—	—	—	—
CD32162	—	BA592	—	—	—	—	—	—	—
F32162	SFE5,5	SFE5,5	—	—	—	—	—	—	—
CR32163	680	680	—	—	—	—	—	—	—
BR32165	X	X	—	—	—	X	X	—	X
CD32167	—	BA592	—	—	—	0 OHM	0 OHM	—	—
F32167	—	SFE6,0	—	—	—	—	—	—	—
BR32167	—	X	—	—	—	X	X	—	X
CR32410	0 OHM	—	0 OHM	—	0 OHM	0 OHM	—	0 OHM	—
F32410	8141-107-600	8140-531-351	8141-107-600	8140-531-351	8141-107-600	8141-107-600	8141-107-600	8141-531-351	8140-531-351
CD32411	—	BA592	—	BA592	BA592	BA592	—	BA592	—
CC32412	—	1n	—	1n	1n	1n	—	1n	—
CR32412	0 OHM	1k	0 OHM	1k	1k	1k	0 OHM	470	470
F32412	G1985	K3451	G1984	K3451	K3453	G6255	K3451	G1984	K3451
CR32420	0 OHM	—	0 OHM	—	—	0 OHM	—	0 OHM	—
CD32421	—	BA592	—	BA592	BA592	—	BA592	—	BA592
CR32451	—	—	—	—	0 OHM	0 OHM	—	—	—
CR32455	—	—	—	—	0 OHM	0 OHM	—	0 OHM	—
CT32470	—	—	—	—	BC848	—	BC848	—	BC848
CR32471	—	—	—	—	22k	—	22k	—	22k
CR32472	—	—	—	—	10k	—	10k	—	10k
CR32473	—	—	—	—	0 OHM	—	22k	—	22k
CD32475	—	0 OHM	—	0 OHM	0 OHM	0 OHM	BA592	—	BA592
CT32475	—	BC848	—	BC848	BC848	—	BC848	—	BC848
CR32476	—	2,2k	—	2,2k	2,2k	4,7k	2,2k	—	2,2k
CT32480	—	BC848	—	BC848	BC848	BC848	—	—	—
CR32482	—	—	—	—	22k	—	22k	—	22k
CR32486	—	2,2k	—	2,2k	2,2k	2,2k	2,2k	—	2,2k
IC32490	—	U4467	—	U4467	—	—	U4488	—	U4488
CC32492	—	—	—	—	—	—	—	—	1n
CR32527/CR32528	0 OHM	—	—	—	—	0 OHM	—	0 OHM	—
C33019	1u	2,2u	1u	2,2u	1u	1u	2,2u	1u	2,2u
CC33021	—	1u	—	1u	—	—	1u	—	1u
CC33022	—	—	—	—	—	—	—	—	1u
IC34015	TDA8840	TDA8842	TDA8840	TDA8842	TDA8841	TDA8841	TDA8842	TDA8840	TDA8842
CC34039	—	0,22u	—	0,22u	—	0,22u	0,22u	—	0,22u
CR43017	0 OHM	—	0 OHM	—	0 OHM	—	0 OHM	—	0 OHM
BR43021	—	—	—	—	—	—	—	—	X
CR81010	—	0 OHM	—	0 OHM	—	0 OHM	—	0 OHM	—
OPTION A	—	X	—	X	X	X	X	—	X
OPTION B	—	X	—	X	X	X	X	—	X
OPTION C	—	X	—	X	X	X	X	—	X
OPTION D1/D2	—	—	—	—	—	—	—	—	—
OPTION F/G	—	X	—	X	X	X	X	—	X
OPTION H1/H2	—	X	—	X	X	X	X	—	X
OPTION I	—	X	—	X	X	X	X	—	X
OPTION L	—	X	—	X	X	X	X	—	X

CUC 2003 MONO
CUC 2003 H MONO

SAT-NACHRUESTUNG RETROFITTING SAT	R34073	R43014 R43001 R43019	R44014 R44013
MONO	1	1	1
MONO SAT	-	-	-
STEREO	-	-	1
STEREO SAT	-	-	-

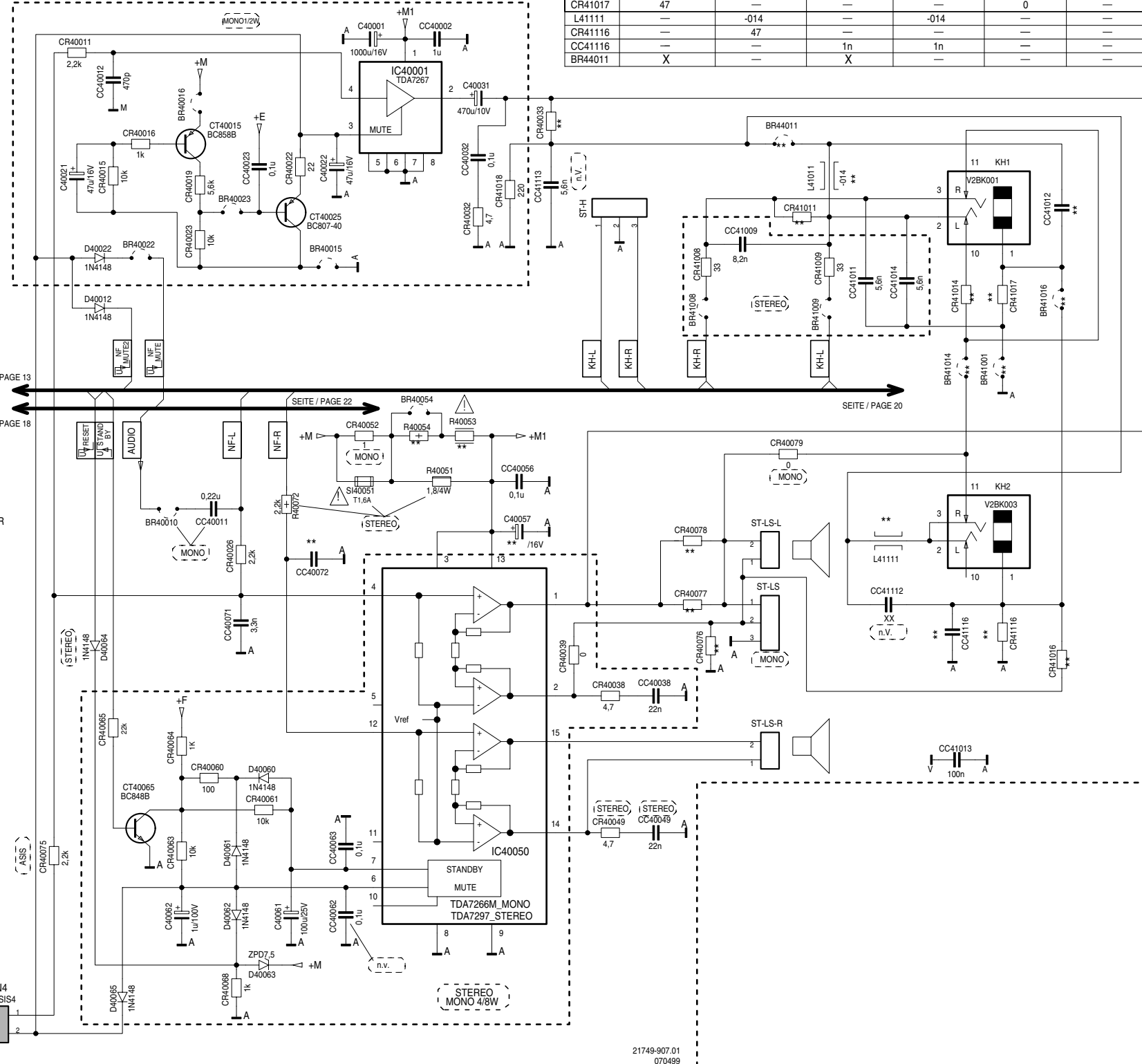

Chassisplatte Megasis - 3 / Chassis Board Megasis - 3 (Materialnummer / Part Number 29504 108 2300)

Bestückungsseite, Ansicht von oben / Component Side, Top View

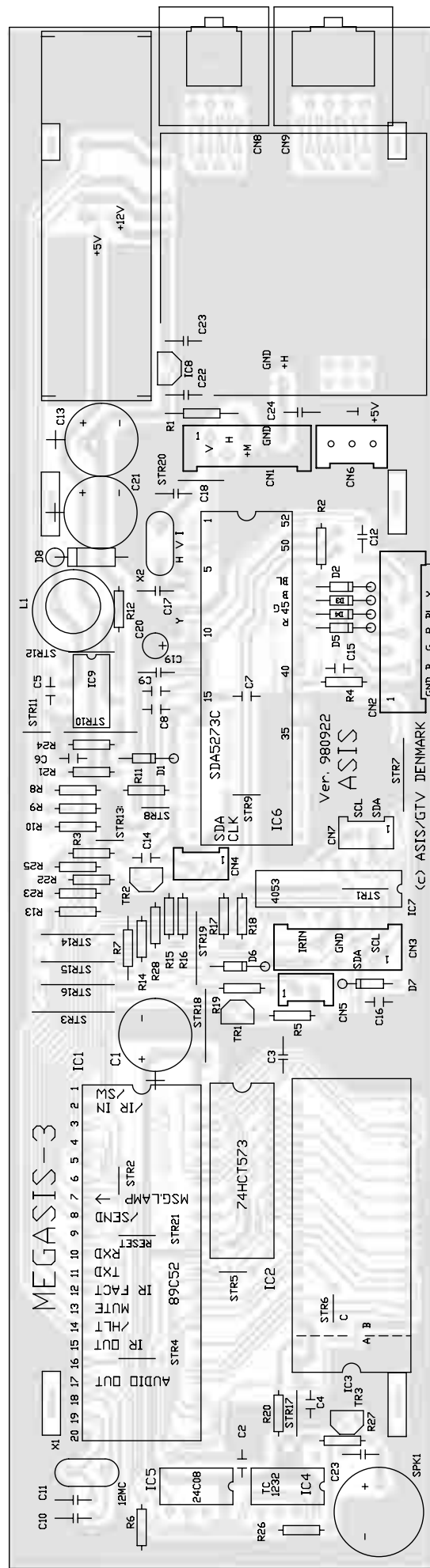

Masseleitung anlöten / Solder on ground cable



Masseleitung zwischen ASIS Kabel durchführen / Lay the ground cable between the ASIS cable

Steckerbelegung CUC 2003 zum Meg-ASIS 3 Modul / Plug Configuration CUC 2003 to Meg-ASIS 3 Module

Stecker auf ASIS-Modul / Plug on ASIS Module	Farbe Stecker / Colour of Plug	Signal	Stecker Chassis / Chassis Plug	Lage der Stecker auf TV Chassis / Position of Plugs on TV Chassis	Materialnummer der Kabel / Part Number of Cable
CN 1	schwarz / black	V Sync H Sync + M Masse / Ground + 5 V / ASIS	ST-ASIS 1, Pin 1 ST-ASIS 1, Pin 2 ST-ASIS 1, Pin 3 ST-ASIS 1, Pin 4 ST-ASIS 1, Pin 5	Seite / Page 17	29210 805 2200
CN 2	weiß / white	Masse / Ground B G R RGB-Schaltspannung RGB switching voltage FBAS Text / CCVS text BUS Reset	ST-ASIS 2, Pin 1 ST-ASIS 2, Pin 2 ST-ASIS 2, Pin 3 ST-ASIS 2, Pin 4 ST-ASIS 2, Pin 5 ST-ASIS 2, Pin 6 ST-ASIS 2, Pin 7	Seite / Page 20	29210 807 0100
CN 3	blau / blue	Clock Data Masse / Ground IR Ausgang / IR out IR Eingang / IR in	ST-ASIS 3, Pin 1 ST-ASIS 3, Pin 2 ST-ASIS 3, Pin 3 ST-ASIS 3, Pin 4 ST-ASIS 3, Pin 5	Seite / Page 17	29210 805 8200
CN 4	rot / red	NF Stumm / NF Mute	ST-ASIS 4, Pin 1 ST-ASIS 4, Pin 2	Seite / Page 23	29210 802 4200
CN 5	weiß / white		ST-M-LED, Pin 1 ST-M-LED, Pin 2	Seite / Page 18	29210 802 0200
CN 6	weiß / white	+ 12 V + 5 V Masse / Ground	Standby Netzteil Pin 1 / Standby Power Supply Pin 1 Standby Netzteil Pin 2 / Standby Power Supply Pin 2 Standby Netzteil Pin 3 / Standby Power Supply Pin 3		29210 803 0200
Massekabel / Ground Cable		Masse / Ground			29210 271 4400

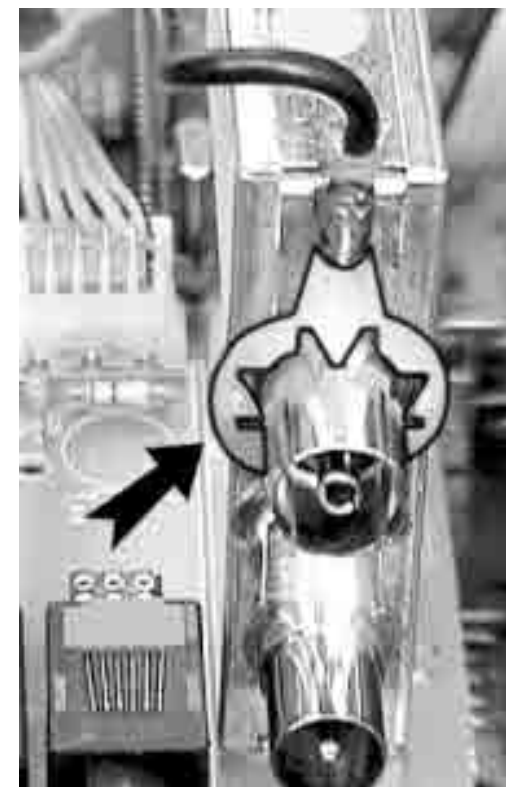

Massering aufstecken / Attach ground ring



Ansicht von der Rückseite / Back view of chassis board

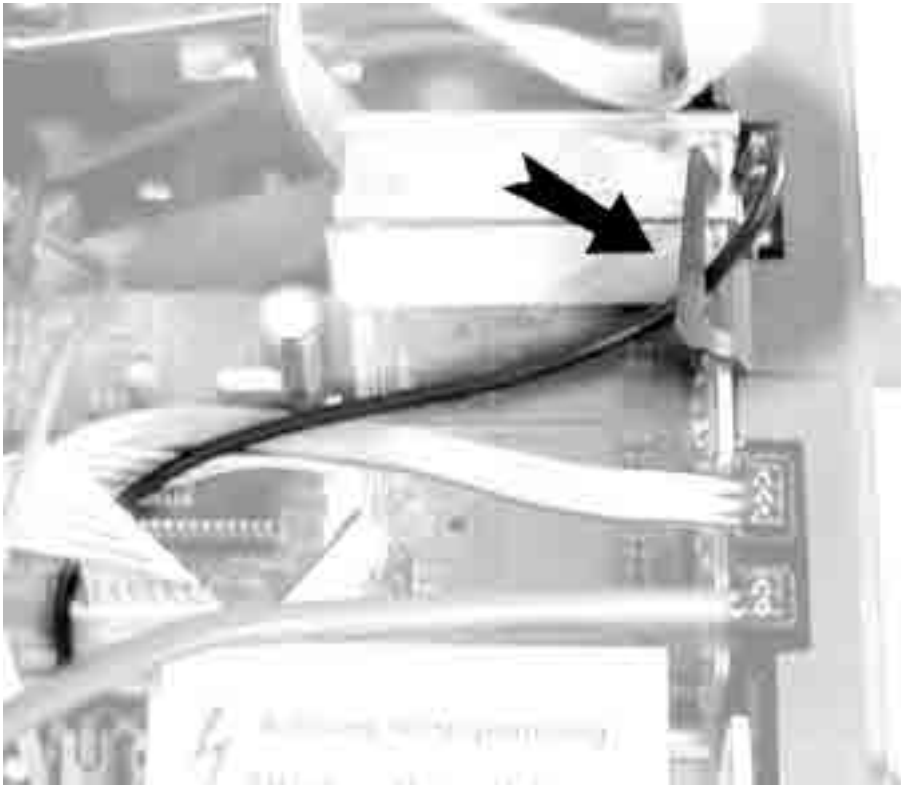

Masseleitung fixieren / Secure ground cable



Draufsicht CUC 2003 + MegASIS card / Top view CUC 2003 + MegASIS card

Ersatzteilliste
Spare Parts List

TV





4 / 99

NETZTEIL 5V/12V ASIS
POWER SUPPLY 5V/12V ASIS

MATERIAL-NR. / PART NO.: 29304 050 8000

POS. NR. POS. NO.	ABB. FIG.	MATERIAL-NR. PART NUMBER	ANZ. QTY.	BEZEICHNUNG D	DESCRIPTION GB
		29304 050 8000		NETZTEIL 5/12V GRUNDIG ASIS KEIN E-TEIL	POWER SUPPLY 5/12V GRUNDIG ASIS NO SPARE PART
0010.000		29303 153 1208		MONTAGECLIP	MOUNTING CLIP
0020.000		09621 113 0206	2	SICHERUNGSHALTER	FUSE HOLDER
0030.000		81049 820 1400		DAEMPF-PERLE 433003038102	DAMPING BEAD 4330 030 38102

POS. NR. POS. NO.	MATERIAL-NR. PART NUMBER	BEZEICHNUNG DESCRIPTION	POS. NR. POS. NO.	MATERIAL-NR. PART NUMBER	BEZEICHNUNG DESCRIPTION
----------------------	-----------------------------	----------------------------	----------------------	-----------------------------	----------------------------

C 60210  86600 982 3400 SI-KERKO B-SS 1000PF 20%
 C 60251  85117 930 1800 MP3 0,1UF 20% 250VW WIM/P
 C 60252  85117 930 1800 MP3 0,1UF 20% 250VW WIM/P
 C 60253  86600 982 3400 SI-KERKO B-SS 1000PF 20%
 C 60254  86600 982 3400 SI-KERKO B-SS 1000PF 20%



D 60202 83092 011 5900 DIODE BA159
 D 60203 83096 631 8000 Z-DIODE BZT03D180
 D 60204 83092 000 2100 DIODE BAV21 ITT/TFK
 D 60213 83097 201 0900 Z DIODE 11 B 0,5W
 D 60256 83092 151 2700 DIODE 1 N 4007 -GA
 D 60257 83092 151 2700 DIODE 1 N 4007 -GA
 D 60258 83092 151 2700 DIODE 1 N 4007 -GA
 D 60259 83092 151 2700 DIODE 1 N 4007 -GA
 D 61211 83095 167 5500 DIODE BYT 53 D

IC 60201 83055 800 2000 IC VIPER20A/022Y SGS
 IC 61211 83052 057 0300 IC MC7805CT

L 60251  29500 823 9600 FUNKENTSTOERDROSSEL
 INTERFERENCE SUPPR. COIL

OK60210  83060 000 1200 OPTOKOPPLER CNY17F1/ CNY1

R 60251  87650 491 6100 MSW 0414 4,7 MOHM VDE BEY

SI 60201  83156 100 2600 LOET-SI-GR 200 MA/T
 SI 60251  83156 200 0300 SI 5X20 T2A L 250V
 SI 61211  83156 150 2700 SI LOET T630MA

TR60201  29201 619 9700 TRAF0 SPERRWANDLER KPL
 B.O.-TYPE CONVERTER
 TRANSFORMER

Es gelten die Vorschriften und Sicherheitshinweise gemäß dem Service Manual "Sicherheit", Mat.-Nummer 72010 800 0000, sowie zusätzlich die eventuell abweichenden, landesspezifischen Vorschriften!



The regulations and safety instructions shall be valid as provided by the "Safety" Service Manual, part number 72010 800 0000, as well as the respective national deviations.

ÄNDERUNGEN VORBEHALTEN / SUBJECT TO ALTERATION

Btx *32700#

Ersatzteilliste
Spare Parts List

TV





4 / 99

NETZTEIL STAND BY ASIS
POWER SUPPLY STAND BY ASIS

MATERIAL-NR. / PART NO.: 29304 050 8100

POS. NR. POS. NO.	ABB. FIG.	MATERIAL-NR. PART NUMBER	ANZ. QTY.	BEZEICHNUNG D	DESCRIPTION GB
		29304 050 8100		NETZTEIL STAND BY ASIS KEIN E-TEIL	POWER SUPPLY STAND BY ASIS NO SPARE PART
0010.000		29303 153 1208		MONTAGECLIP	MOUNTING CLIP
0020.000		09621 113 0206	2	SICHERUNGSHALTER	FUSE HOLDER
0030.000		81049 820 1400		DAEMPF-PERLE 433003038102	DAMPING BEAD 4330 030 38102

POS. NR. POS. NO.	MATERIAL-NR. PART NUMBER	BEZEICHNUNG DESCRIPTION	POS. NR. POS. NO.	MATERIAL-NR. PART NUMBER	BEZEICHNUNG DESCRIPTION
----------------------	-----------------------------	----------------------------	----------------------	-----------------------------	----------------------------

C 60210  86600 982 3400 SI-KERKO B-SS 1000PF 20%
 C 60251  85117 930 1800 MP3 0,1UF 20% 250VW WIM/P
 C 60252  85117 930 1800 MP3 0,1UF 20% 250VW WIM/P
 C 60253  86600 982 3400 SI-KERKO B-SS 1000PF 20%
 C 60254  86600 982 3400 SI-KERKO B-SS 1000PF 20%



D 60202 83092 011 5900 DIODE BA159
 D 60203 83096 631 8000 Z-DIODE BZT03D180
 D 60204 83092 000 2100 DIODE BAV21 ITT/TFK
 D 60213 83097 201 6100 Z DIODE 16 B 0,5W
 D 60256 83092 151 2700 DIODE 1 N 4007 -GA
 D 60257 83092 151 2700 DIODE 1 N 4007 -GA
 D 60258 83092 151 2700 DIODE 1 N 4007 -GA
 D 60259 83092 151 2700 DIODE 1 N 4007 -GA
 D 61211 83095 167 5500 DIODE BYT 53 D

IC 60201 83055 800 2000 IC VIPER20A/022Y SGS
 IC 61211 83052 020 5200 IC MC7812CT MOT/ CU PHI/

L 60251  29500 823 9600 FUNKENTSTOERDROSSEL
 INTERFERENCE SPPR. COIL

O60210  83060 000 1200 OPTOKOPPLER CNY17F1/ CNY1

R 60251  87650 491 6100 MSW 0414 4,7 MOHM VDE BEY

SI 60201  83156 100 2600 LOET-SI-GR 200 MA/T
 SI 60251  83156 200 0300 SI 5X20 T2A L 250V
 SI 61211  83156 162 0500 SI LOET T800MA 250V

TR60201  29201 619 9700 TRAF0 SPERRWANDLER KPL
 B.O.-TYPE CONVERTER
 TRANSFORMER

Es gelten die Vorschriften und Sicherheitshinweise gemäß dem Service Manual "Sicherheit", Mat.-Nummer 72010 800 0000, sowie zusätzlich die eventuell abweichenden, landesspezifischen Vorschriften!



The regulations and safety instructions shall be valid as provided by the "Safety" Service Manual, part number 72010 800 0000, as well as the respective national deviations.

ÄNDERUNGEN VORBEHALTEN / SUBJECT TO ALTERATION

Btx *32700#