

E14 Power Window Regulator Master Switch Assembly

Power Window <LHD>

- \* 1 : w/ Rear Power Window
- \* 2 : Before Jun. 2010 Production
- \* 3 : From Jun. 2010 Production

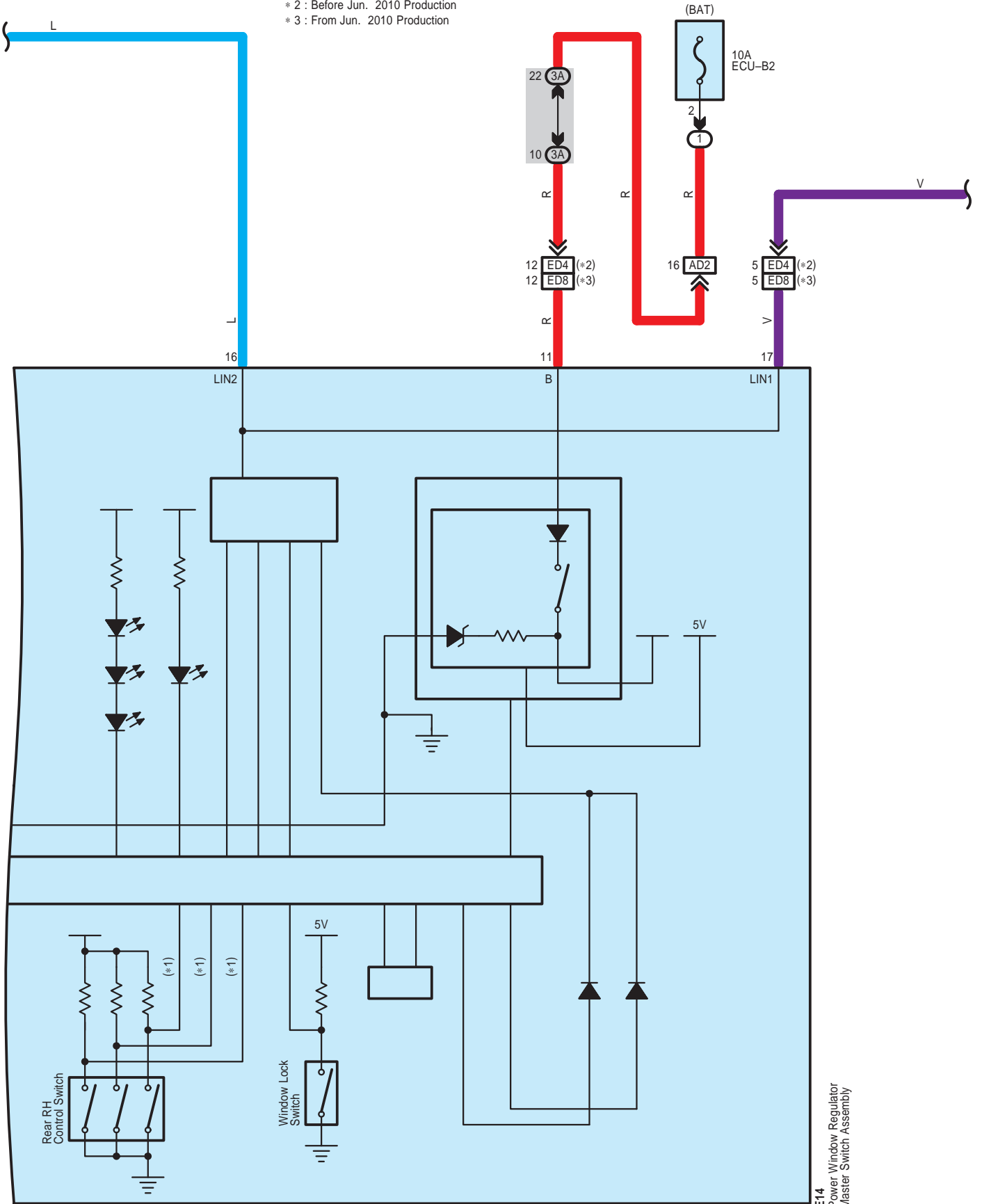

E14 Power Window Regulator Master Switch Assembly

Power Window <LHD>

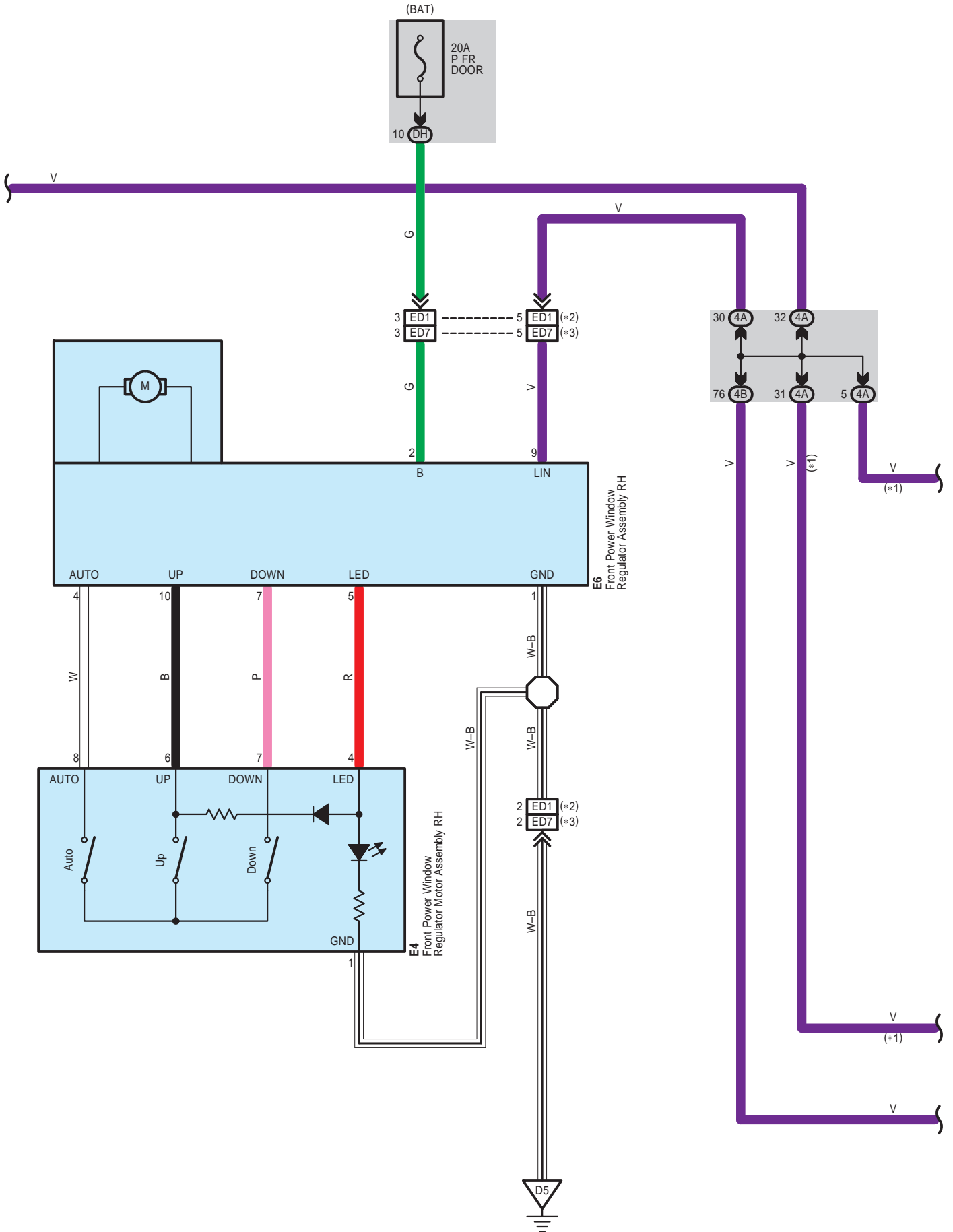



Power Window <LHD>

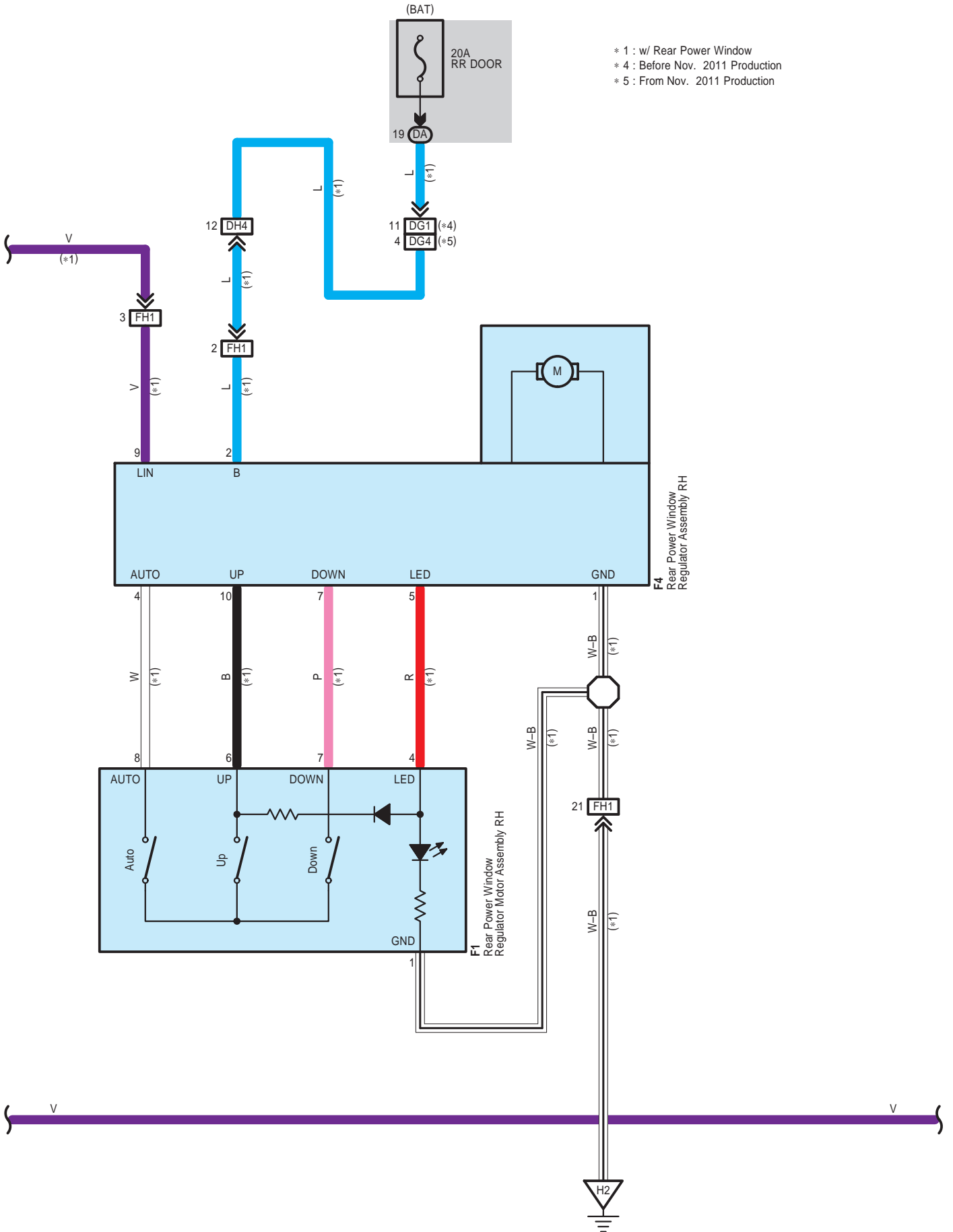

Power Window <LHD>

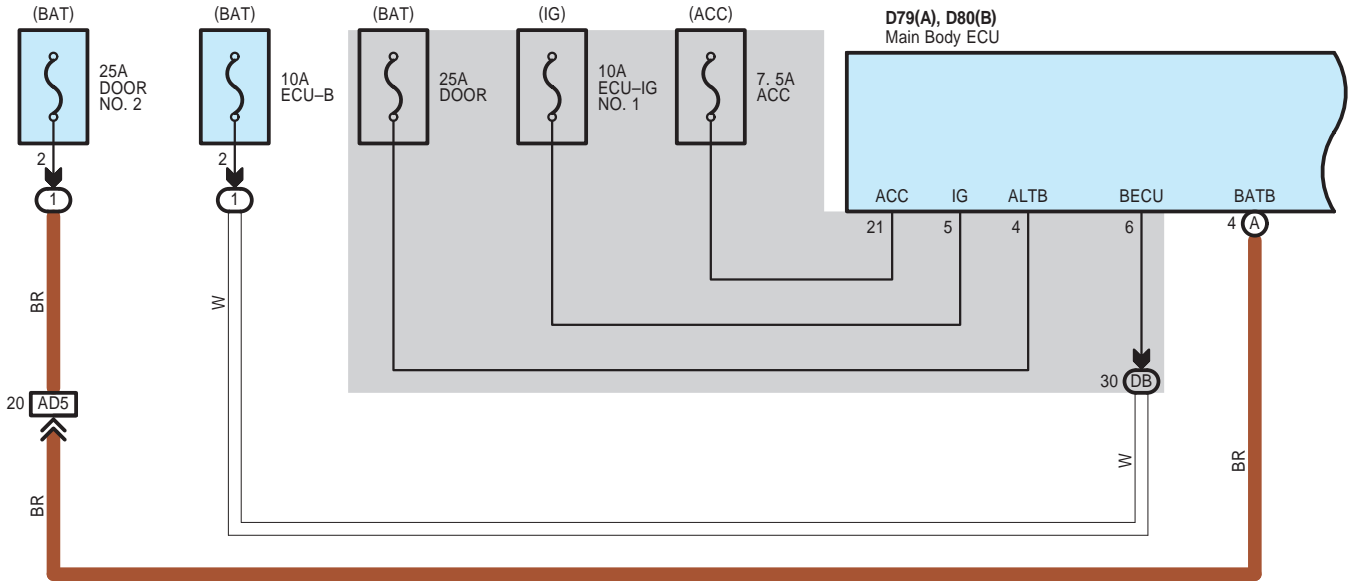

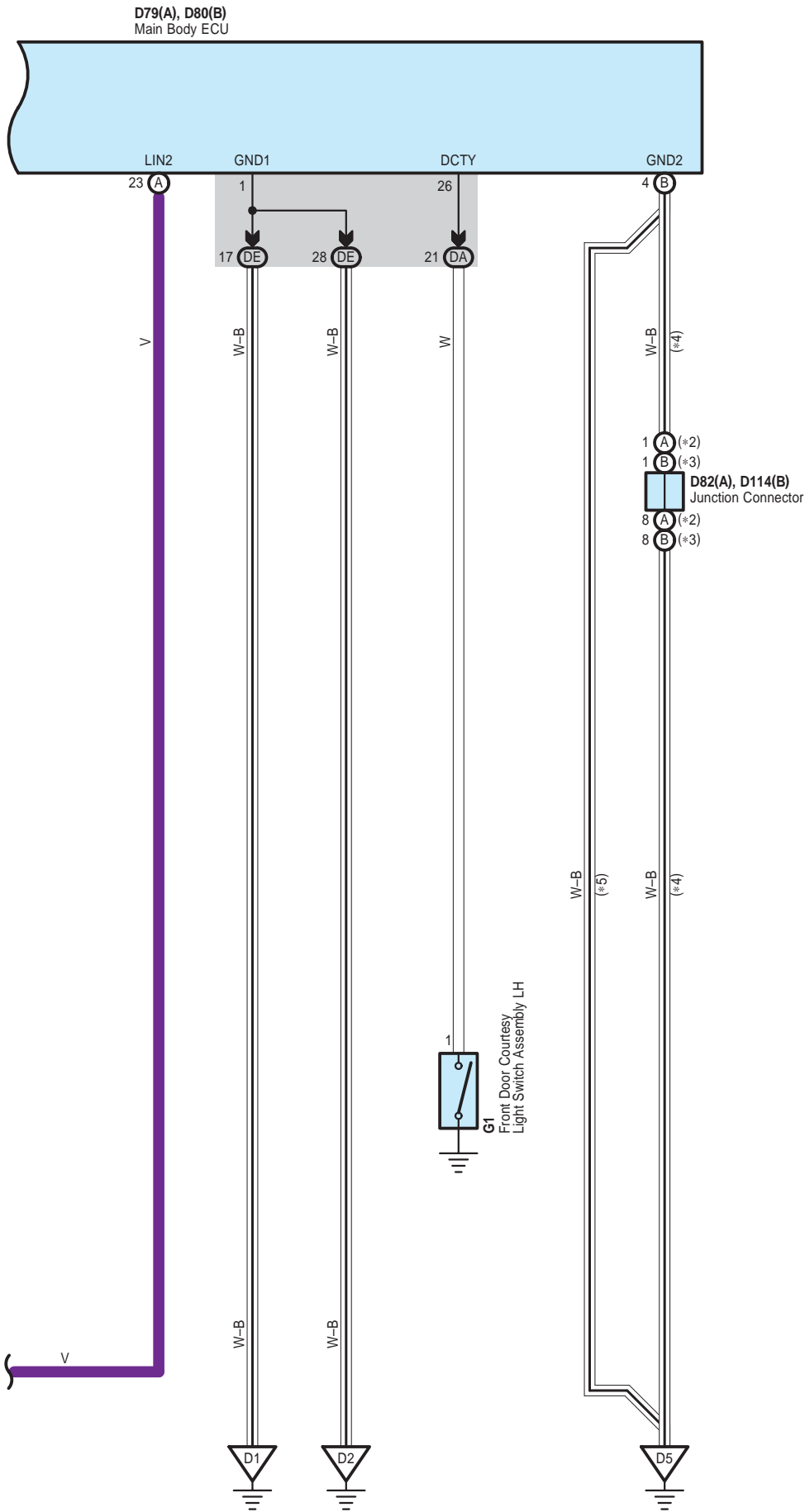

- \* 2 : Before Jun. 2010 Production
- \* 3 : From Jun. 2010 Production
- \* 4 : Before Nov. 2011 Production
- \* 5 : From Nov. 2011 Production

D 79  
White

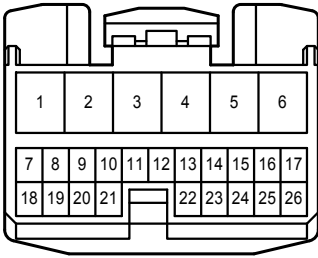

D 80  
White

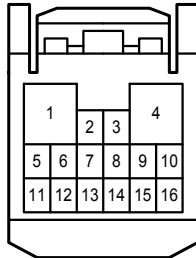

D 82  
Black

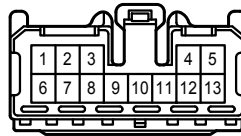

D114  
White

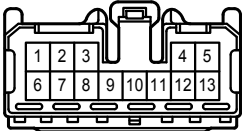

E 4  
Black

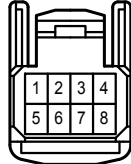

E 6  
White

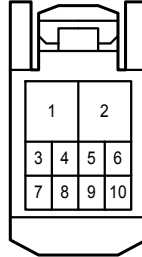

E 14  
Black

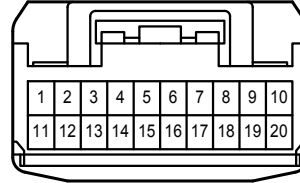

E 15  
White

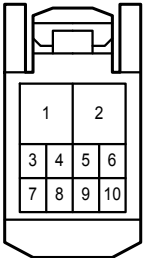

F 1  
Black

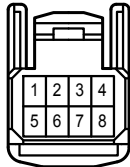

F 4  
White

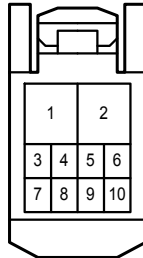

F 6  
Black

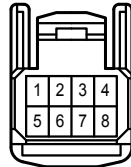

F 9  
White

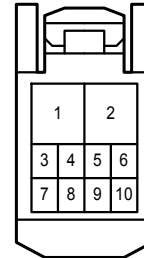

G 1  
White



3A  
White

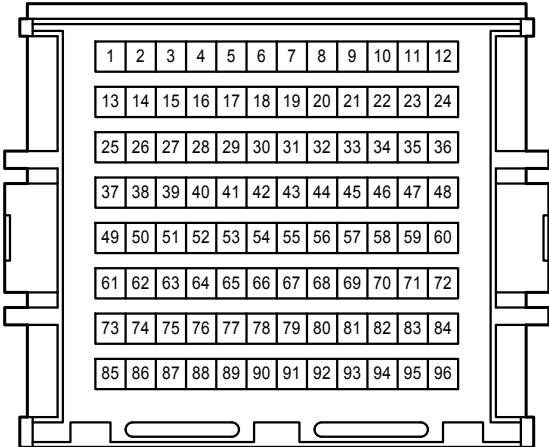

4A  
White

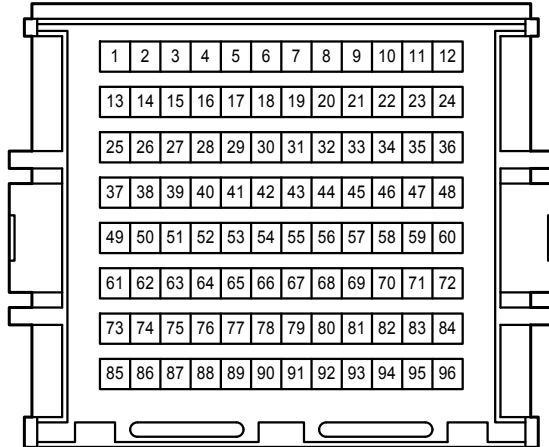



4B  
White

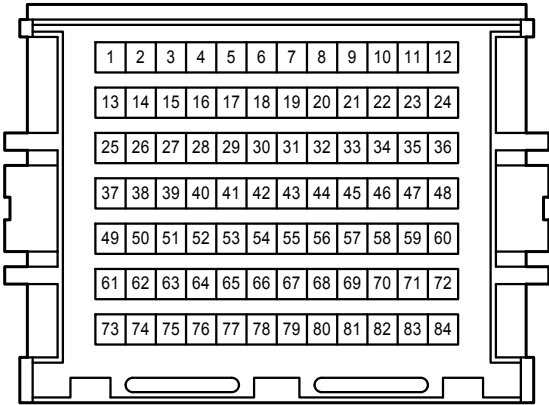

DA  
White

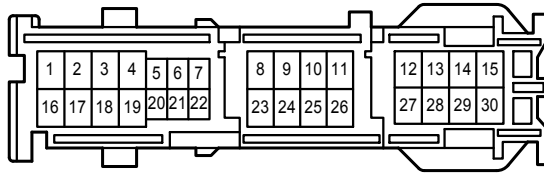

DB  
White

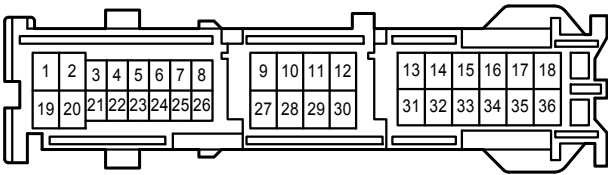

DE  
White

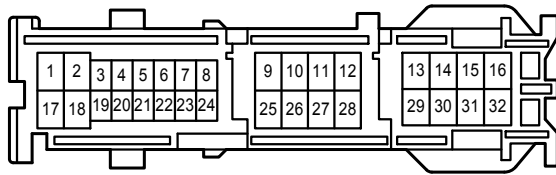

DH  
White

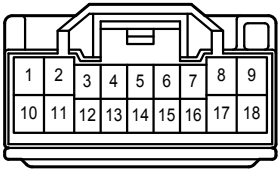

AD2  
Gray

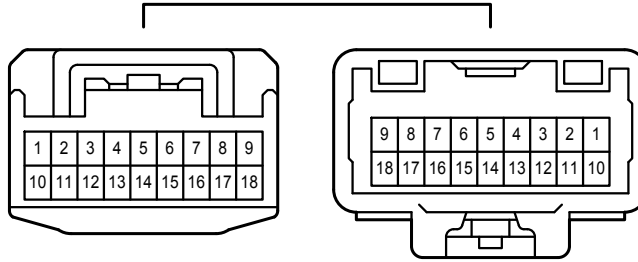

AD5  
White

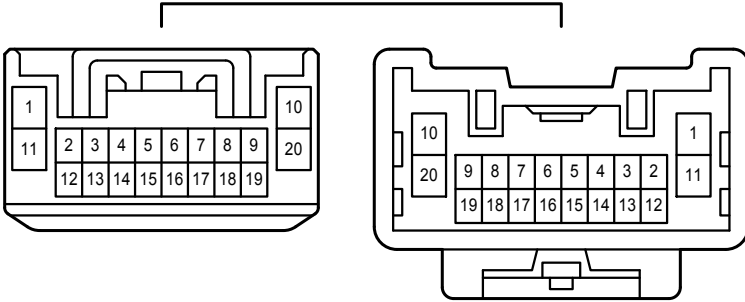

DG1  
White

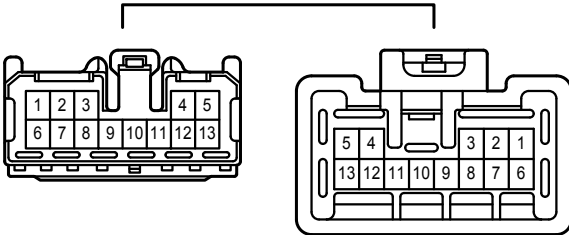

DG2  
Gray

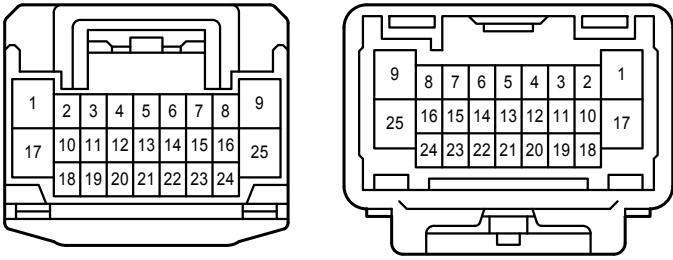

DG4  
White

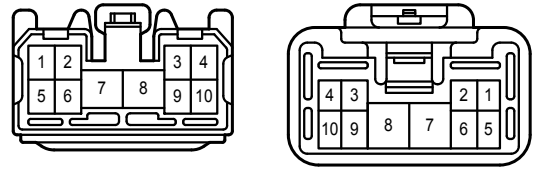

DG5  
White

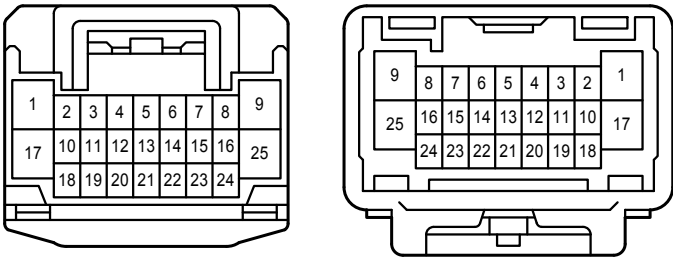

DH4  
White

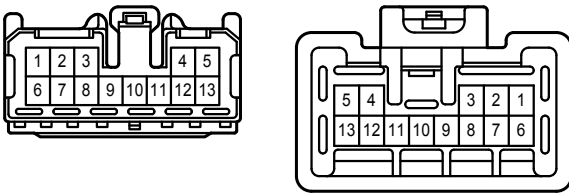

ED1  
Blue

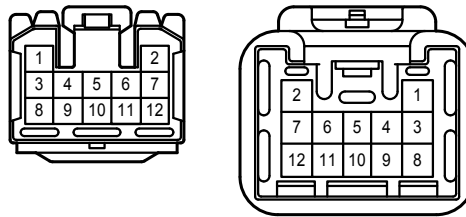

ED4  
Blue

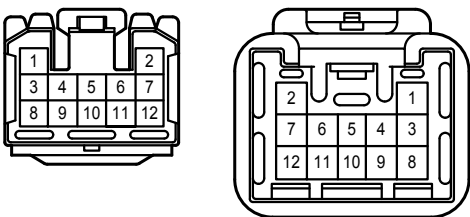

ED7  
White

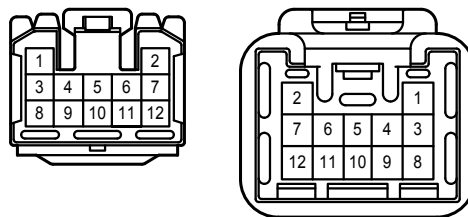

ED8  
White

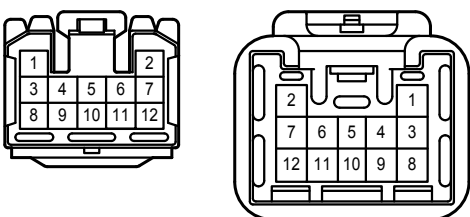

Power Window <LHD>

FG1  
White

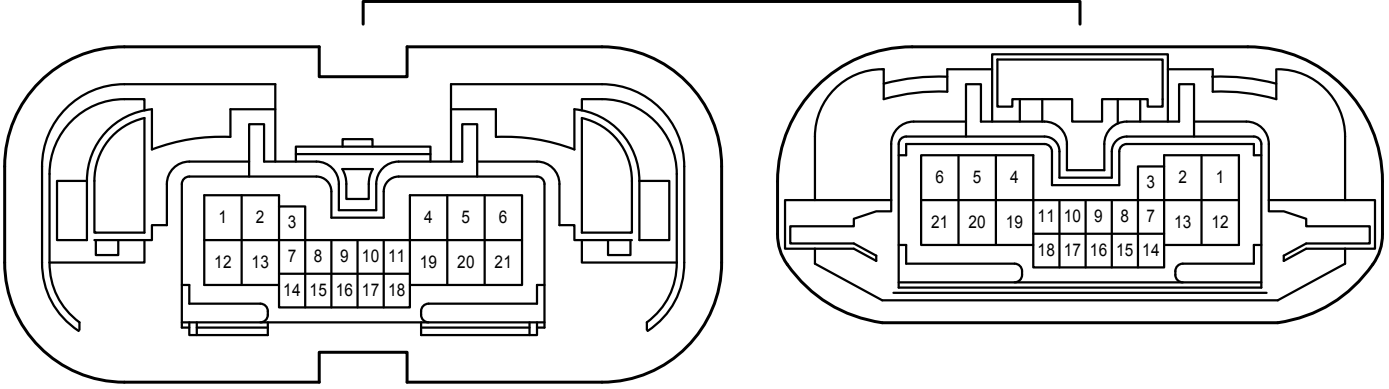

FH1  
White

