



## P-Channel 60-V (D-S) MOSFET

### PRODUCT SUMMARY

Part Number	$V_{(BR)DSS}$ Min (V)	$r_{DS(on)}$ Max ( $\Omega$ )	$V_{GS(th)}$ (V)	$I_D$ (A)
TP0610L	-60	10 @ $V_{GS} = -10$ V	-1 to -2.4	-0.18
TP0610T	-60	10 @ $V_{GS} = -10$ V	-1 to -2.4	-0.12
VP0610L	-60	10 @ $V_{GS} = -10$ V	-1 to -3.5	-0.18
VP0610T	-60	10 @ $V_{GS} = -10$ V	-1 to -3.5	-0.12
BS250	-60	10 @ $V_{GS} = -10$ V	-1 to -3.5	-0.18

### FEATURES

- High-Side Switching
- Low On-Resistance: 8  $\Omega$
- Low Threshold: -1.9 V
- Fast Switching Speed: 16 ns
- Low Input Capacitance: 15 pF

### BENEFITS

- Ease in Driving Switches
- Low Offset (Error) Voltage
- Low-Voltage Operation
- High-Speed Switching
- Easily Driven Without Buffer

### APPLICATIONS

- Drivers: Relays, Solenoids, Lamps, Hammers, Displays, Memories, Transistors, etc.
- Battery Operated Systems
- Power Supply, Converter Circuits
- Motor Control

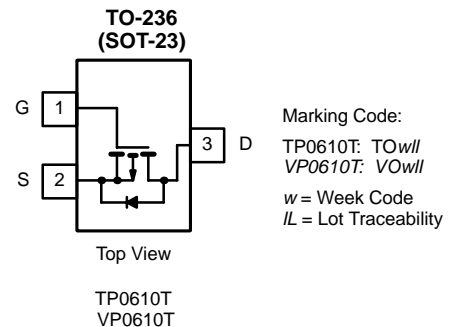
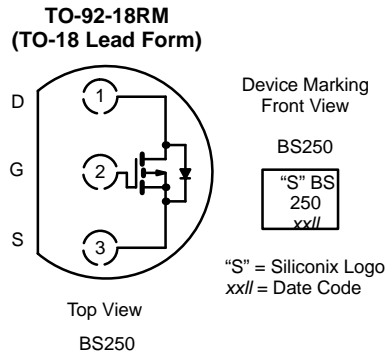
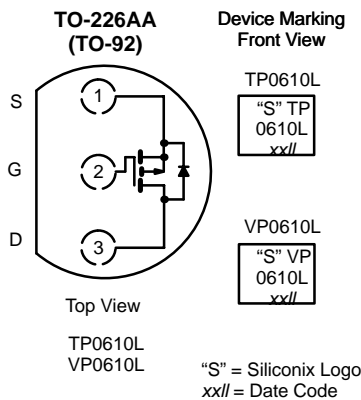

### ABSOLUTE MAXIMUM RATINGS ( $T_A = 25^\circ\text{C}$ UNLESS OTHERWISE NOTED)

Parameter	Symbol	TP0610L	TP0610T	VP0610L	VP0610T	BS250	Unit	
Drain-Source Voltage	$V_{DS}$	-60	-60	-60	-60	-60	V	
Gate-Source Voltage	$V_{GS}$	$\pm 20$	$\pm 20$	$\pm 20$	$\pm 20$	$\pm 20$		
Continuous Drain Current ( $T_J = 150^\circ\text{C}$ )	$T_A = 25^\circ\text{C}$	-0.18	-0.12	-0.18	-0.12	-0.18	A	
	$T_A = 100^\circ\text{C}$	-0.11	-0.07	-0.11	-0.07			
Pulsed Drain Current <sup>a</sup>	$I_{DM}$	-0.8	-0.4	-0.8	-0.4			
Power Dissipation	$T_A = 25^\circ\text{C}$	0.8	0.36	0.8	0.36	0.83	W	
	$T_A = 100^\circ\text{C}$	0.32	0.14	0.32	0.14			
Thermal Resistance, Junction-to-Ambient	$R_{thJA}$	156	350	156	350	150	$^\circ\text{C}/\text{W}$	
Operating Junction and Storage Temperature Range	$T_J, T_{stg}$	-55 to 150						$^\circ\text{C}$

Notes

a. Pulse width limited by maximum junction temperature.

For applications information see AN804.

SPECIFICATIONS (T <sub>A</sub> = 25 °C UNLESS OTHERWISE NOTED)										
Parameter	Symbol	Test Conditions	Typ <sup>a</sup>	Limits						Unit
				TP0610L/T		VP0610L/T		BS250		
				Min	Max	Min	Max	Min	Max	
<b>Static</b>										
Drain-Source Breakdown Voltage	V <sub>(BR)DSS</sub>	V <sub>GS</sub> = 0 V, I <sub>D</sub> = -10 μA		-60		-60				V
		V <sub>GS</sub> = 0 V, I <sub>D</sub> = -100 μA					-60			
Gate-Threshold Voltage	V <sub>GS(th)</sub>	V <sub>DS</sub> = V <sub>GS</sub> , I <sub>D</sub> = -250 μA		-1	-2.4	-1	-3.5	-1	-3.5	
Gate-Body Leakage	I <sub>GSS</sub>	V <sub>DS</sub> = 0 V, V <sub>GS</sub> = ± 10 V			± 200		± 200			nA
		V <sub>DS</sub> = 0 V, V <sub>GS</sub> = ± 10 V, T <sub>J</sub> = 125 °C			± 500					
		V <sub>DS</sub> = 0 V, V <sub>GS</sub> = ± 5 V							± 100	
Zero Gate Voltage Drain Current	I <sub>DSS</sub>	V <sub>DS</sub> = -48 V, V <sub>GS</sub> = 0 V			-1		-1			μA
		V <sub>DS</sub> = -48 V, V <sub>GS</sub> = 0 V, T <sub>J</sub> = 125 °C			-200		-200			
		V <sub>DS</sub> = -25 V, V <sub>GS</sub> = 0 V							-0.5	
On-State Drain Current <sup>b</sup>	I <sub>D(on)</sub>	V <sub>DS</sub> = -10 V, V <sub>GS</sub> = -4.5 V		-50						mA
		V <sub>DS</sub> = -10 V, V <sub>GS</sub> = -10 V	-600			-600				
Drain-Source On-Resistance <sup>b</sup>	r <sub>DS(on)</sub>	V <sub>GS</sub> = -4.5 V, I <sub>D</sub> = -25 mA			25					Ω
		V <sub>GS</sub> = -10 V, I <sub>D</sub> = -0.5 A			10		10			
		V <sub>GS</sub> = -10 V, I <sub>D</sub> = -0.5 A, T <sub>J</sub> = 125 °C			20		20			
		V <sub>GS</sub> = -10 V, I <sub>D</sub> = -0.2 A			10		10		14	
Forward Transconductance <sup>b</sup>	g <sub>fs</sub>	V <sub>DS</sub> = -10 V, I <sub>D</sub> = -0.5 A	20	80						mS
Diode Forward Voltage	V <sub>SD</sub>	I <sub>S</sub> = -0.5 A, V <sub>GS</sub> = 0 V	-1.1		-1.4					V
<b>Dynamic</b>										
Input Capacitance	C <sub>iss</sub>	V <sub>DS</sub> = -25 V, V <sub>GS</sub> = 0 V f = 1 MHz	23		60		60			pF
Output Capacitance	C <sub>oss</sub>		10		25		25			
Reverse Transfer Capacitance	C <sub>rss</sub>		5		5		5			
<b>Switching<sup>c</sup></b>										
Turn-On Time	t <sub>ON</sub>	V <sub>DD</sub> = -25 V, R <sub>L</sub> = 133 Ω I <sub>D</sub> ≅ -0.18 A, V <sub>GEN</sub> = -10 V R <sub>G</sub> = 25 Ω	20							ns
Turn-Off Time	t <sub>OFF</sub>		35							

Notes

- a. For DESIGN AID ONLY, not subject to production testing.
- b. Pulse test: PW ≤ 300 μs duty cycle ≤ 2%.
- c. Switching time is essentially independent of operating temperature.

VPDS06



**TYPICAL CHARACTERISTICS (25°C UNLESS NOTED)**

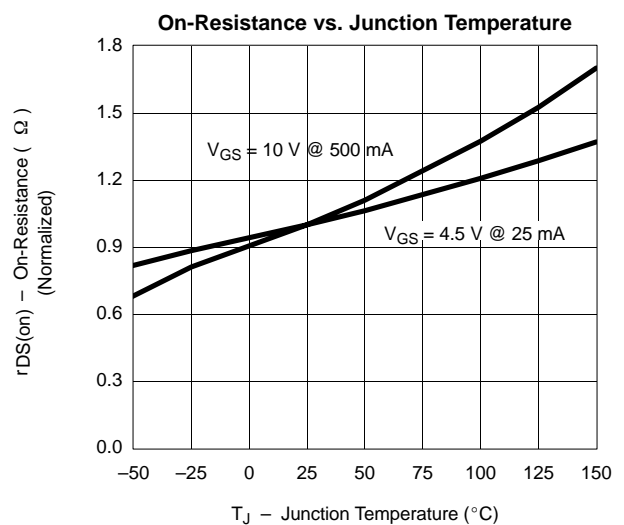
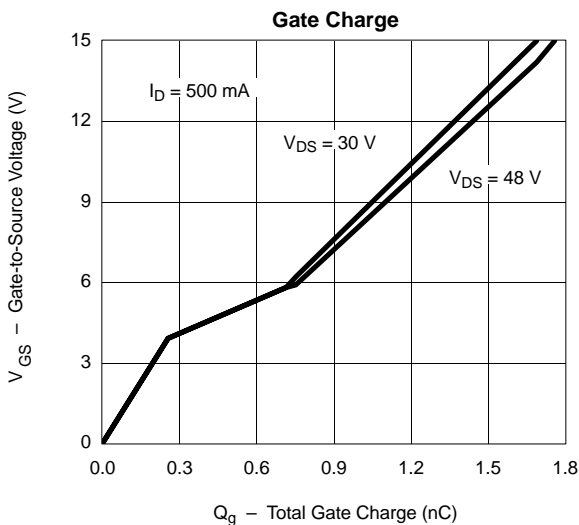
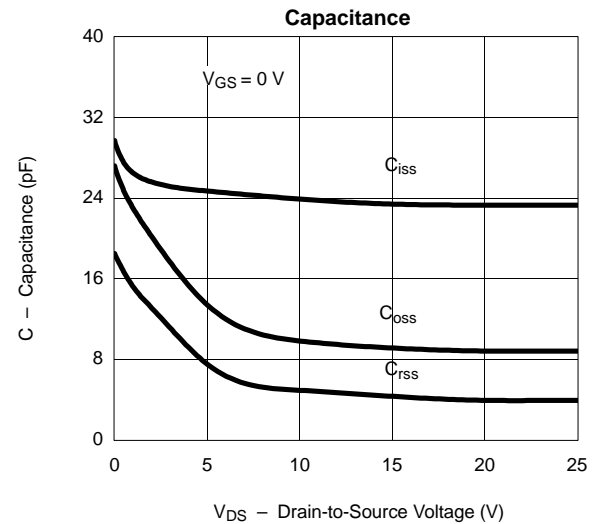
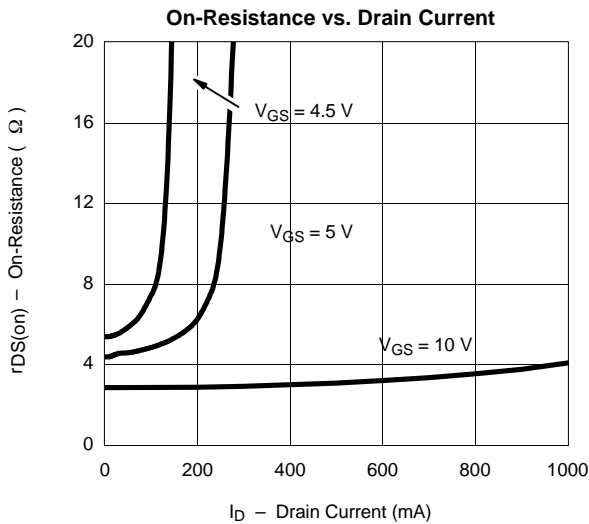
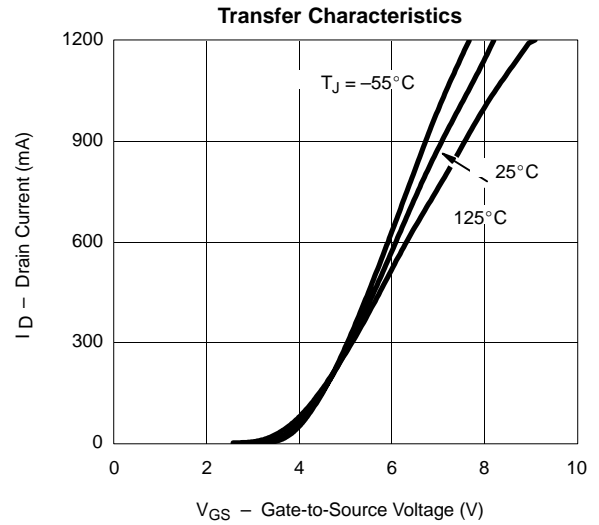
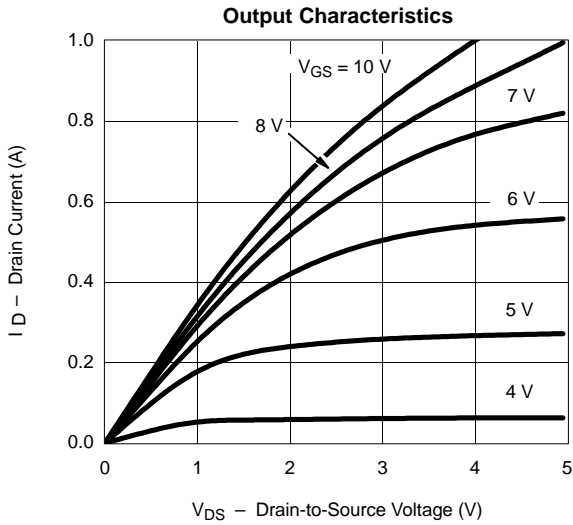

**TYPICAL CHARACTERISTICS (25°C UNLESS NOTED)**

