











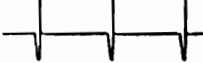



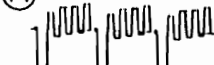

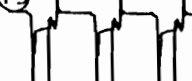

SONY.

TRINITRON® COLOR TV **BASIC SCHEMATIC DIAGRAM**

KV-1434M3B / RM-687B

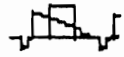
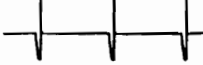
Chassis No. SCC-D06S

<p>①</p>  <p>1.8Vp-p (H)</p>	<p>⑤</p>  <p>PAL 0.2 Vp-p (H)</p>	<p>⑩</p>  <p>3.9Vp-p (H)</p>	<p>⑭</p>  <p>2.2Vp-p (V)</p>	<p>⑱</p>  <p>1.4Vp-p (H)</p>	<p>⑳</p>  <p>720Vp-p (H)</p>
<p>②</p>  <p>PAL 0.4Vp-p (H)</p>	<p>⑥</p>  <p>PAL 0.4Vp-p (H)</p>	<p>⑪</p>  <p>3.9Vp-p (H)</p>	<p>⑮</p>  <p>4.1Vp-p (H)</p>	<p>⑲</p>  <p>12.4Vp-p (H)</p>	
<p>③</p>  <p>PAL 0.2Vp-p (H)</p>	<p>⑦</p>  <p>1.1Vp-p (H)</p>	<p>⑫</p>  <p>1.7Vp-p (H)</p>	<p>⑯</p>  <p>50 Vp-p (V)</p>	<p>⑳</p>  <p>900Vp-p (H)</p>	
<p>④</p>  <p>1.0Vp-p (H)</p>	<p>⑨</p>  <p>3.9Vp-p (H)</p>	<p>⑬</p>  <p>1.8 Vp-p (H)</p>	<p>⑰</p>  <p>1.4Vp-p (V)</p>	<p>㉑</p>  <p>8.0Vp-p (V)</p>	

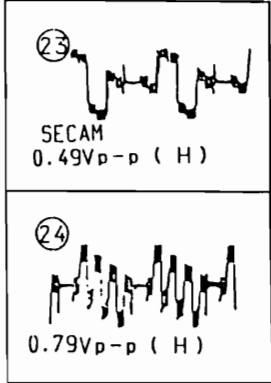
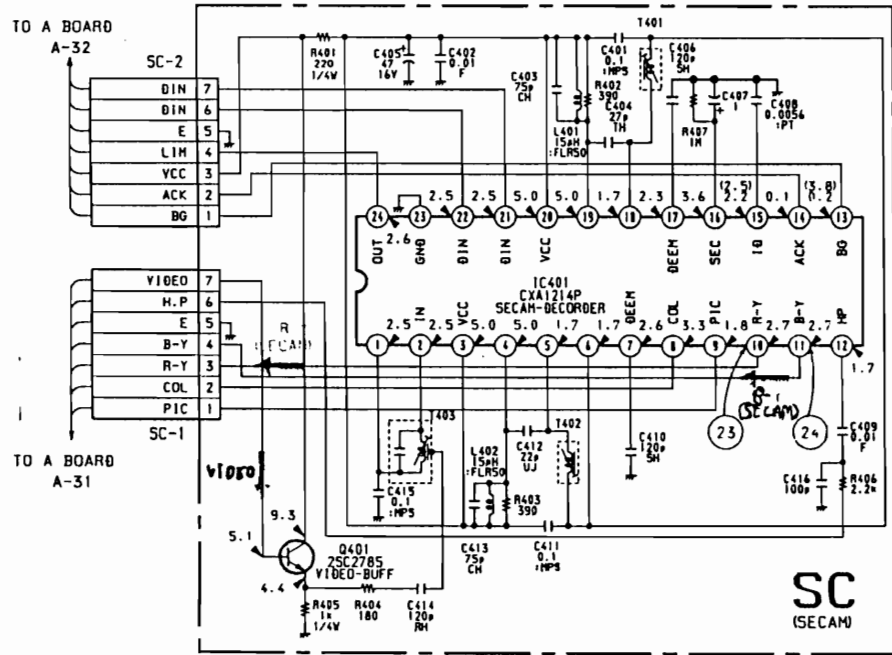

SEMICONDUCTORS

BX-1398
KEY-C00SV

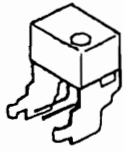

ST24C02CP
μPC4558C

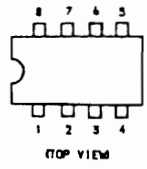

2SA1175-HFE
2SC2785-HFE

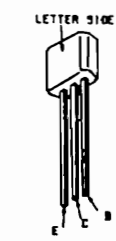

ERC06-15S
R2M

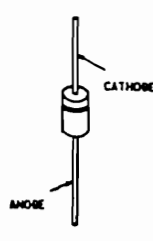

RD2.0ES-B1
RD3.3ES-B1
RD5.1ES-B2
RD6.2ES-B2
RD6.8ES-B2
RD13ES-B1
1SS119

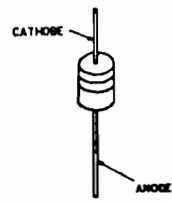

CXA1213S



STR50115B



2SC2611
2SC2688-LK
2SC3271-N

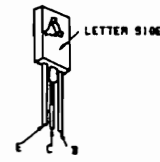

ES1F
GP080D
RGP10G
RGP15J

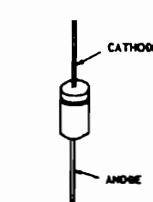

SEL1222R-C, D

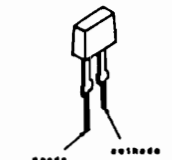

CXA1214P

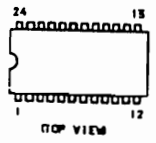

TDA2007

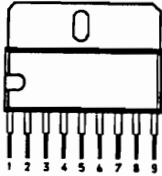

2SD1649-CA

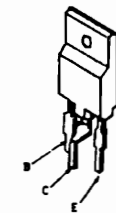

KBU4JL-6088

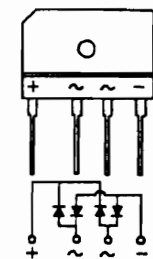

L78LR05D-MA



μPC1488H

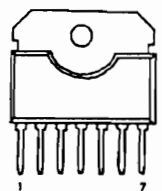

2SD1761-E

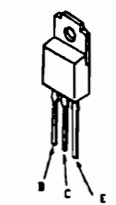

MC921

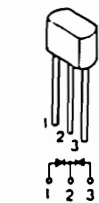

NJM78M09A

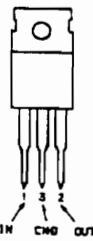

DTA144ES
DTC114ES
DTC124ES
DTC144ES



PCA84C640P-016

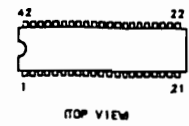

2SK669

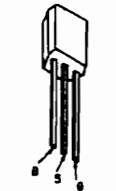

C [R · G · B OUT]

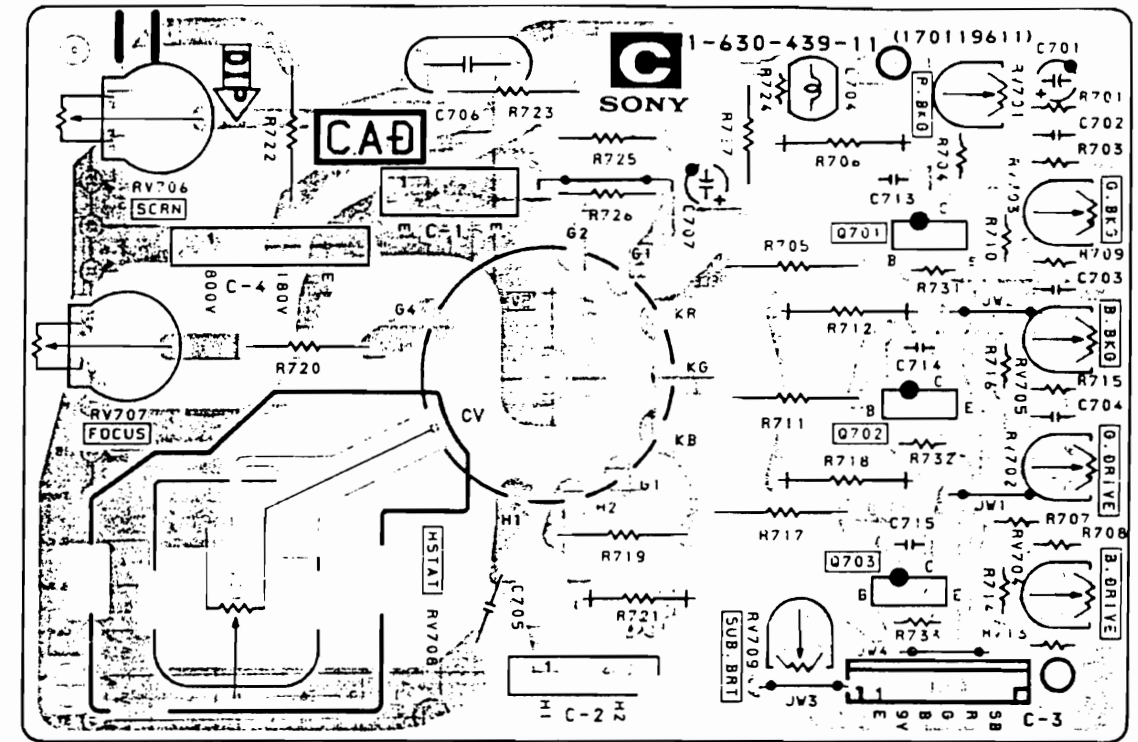

SC [SECAM]

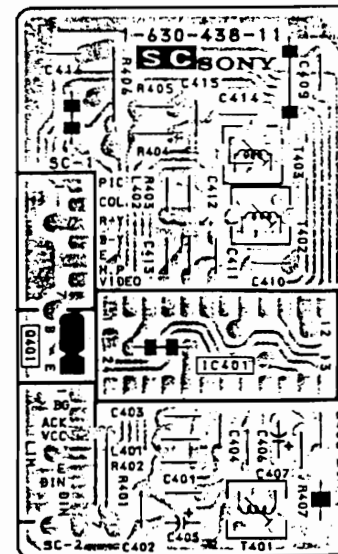

SCHEMATIC DIAGRAMS

