

IRLBA3803

HEXFET® Power MOSFET

- Logic-Level Gate Drive
- Advanced Process Technology
- 175°C Operating Temperature
- Fast Switching
- Fully Avalanche Rated
- Purchase IRLBA3803/P for solder plated option.

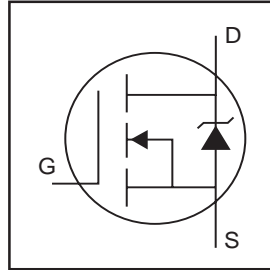

$V_{DSS} = 30V$
 $R_{DS(on)} = 0.005\Omega$
 $I_D = 179A^{\textcircled{A}}$

Description

Fifth Generation HEXFETs from International Rectifier utilize advanced processing techniques to achieve extremely low on-resistance per silicon area. This benefit, combined with the fast switching speed and ruggedized device design that HEXFET Power MOSFETs are well known for, provides the designer with an extremely efficient and reliable device for use in a wide variety of applications.

The Super-220 is a package that has been designed to have the same mechanical outline and pinout as the industry standard TO-220 but can house a considerably larger silicon die. It has increased current handling capability over both the TO-220 and the much larger TO-247 package. This makes it ideal to reduce component count in multiparalleled TO-220 applications, reduce system power dissipation, upgrade existing designs or have TO-247 performance in a TO-220 outline.

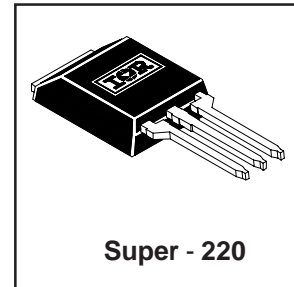

This package has also been designed to meet automotive qualification standard Q101.

Absolute Maximum Ratings

	Parameter	Max.	Units
$I_D @ T_C = 25^\circ C$	Continuous Drain Current, $V_{GS} @ 10V$	179 $\text{\textcircled{A}}$	A
$I_D @ T_C = 100^\circ C$	Continuous Drain Current, $V_{GS} @ 10V$	126 $\text{\textcircled{A}}$	
I_{DM}	Pulsed Drain Current $\text{\textcircled{1}}$	720	
$P_D @ T_C = 25^\circ C$	Power Dissipation	270	W
	Linear Derating Factor	1.8	W/ $^\circ C$
V_{GS}	Gate-to-Source Voltage	± 16	V
E_{AS}	Single Pulse Avalanche Energy $\text{\textcircled{2}}$ $\text{\textcircled{5}}$	610	mJ
I_{AR}	Avalanche Current $\text{\textcircled{1}}$ $\text{\textcircled{5}}$	71	A
E_{AR}	Repetitive Avalanche Energy $\text{\textcircled{1}}$	27	mJ
dv/dt	Peak Diode Recovery dv/dt $\text{\textcircled{3}}$ $\text{\textcircled{5}}$	5.0	V/ns
T_J	Operating Junction and	-55 to + 175	$^\circ C$
T_{STG}	Storage Temperature Range		
	Soldering Temperature, for 10 seconds	300 (1.6mm from case)	
	Recommended clip force	20	N

Thermal Resistance

	Parameter	Typ.	Max.	Units
$R_{\theta JC}$	Junction-to-Case	—	0.55	$^\circ C/W$
$R_{\theta CS}$	Case-to-Sink, Flat, Greased Surface	0.5	—	
$R_{\theta JA}$	Junction-to-Ambient	—	58	

Electrical Characteristics @ T_J = 25°C (unless otherwise specified)

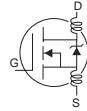
	Parameter	Min.	Typ.	Max.	Units	Conditions
V _{(BR)DSS}	Drain-to-Source Breakdown Voltage	30	—	—	V	V _{GS} = 0V, I _D = 250μA
ΔV _{(BR)DSS/ΔT_J}	Breakdown Voltage Temp. Coefficient	—	0.052	—	V/°C	Reference to 25°C, I _D = 1mA ^⑤
R _{DS(on)}	Static Drain-to-Source On-Resistance	—	—	0.005	Ω	V _{GS} = 10V, I _D = 71A ^④
		—	—	0.009		V _{GS} = 4.5V, I _D = 59A ^④
V _{GS(th)}	Gate Threshold Voltage	1.0	—	—	V	V _{DS} = V _{GS} , I _D = 250μA
g _{fs}	Forward Transconductance	55	—	—	S	V _{DS} = 25V, I _D = 71A ^⑤
I _{DSS}	Drain-to-Source Leakage Current	—	—	25	μA	V _{DS} = 30V, V _{GS} = 0V
		—	—	250		V _{DS} = 24V, V _{GS} = 0V, T _J = 150°C
I _{GSS}	Gate-to-Source Forward Leakage	—	—	100	nA	V _{GS} = 16V
	Gate-to-Source Reverse Leakage	—	—	-100		V _{GS} = -16V
Q _g	Total Gate Charge	—	—	140	nC	I _D = 71A
Q _{gs}	Gate-to-Source Charge	—	—	41		V _{DS} = 24V
Q _{gd}	Gate-to-Drain ("Miller") Charge	—	—	78		V _{GS} = 4.5V, See Fig. 6 and 13 ^{④⑤}
t _{d(on)}	Turn-On Delay Time	—	14	—	nH	V _{DD} = 15V
t _r	Rise Time	—	230	—		I _D = 71A
t _{d(off)}	Turn-Off Delay Time	—	29	—		R _G = 1.3Ω
t _f	Fall Time	—	35	—		R _D = 0.20Ω, See Fig. 10 ^{④⑤}
L _D	Internal Drain Inductance	—	2.0	—	nH	Between lead, 6mm (0.25in.) from package and center of die contact
L _S	Internal Source Inductance	—	5.0	—		
C _{iss}	Input Capacitance	—	5000	—	pF	V _{GS} = 0V
C _{oss}	Output Capacitance	—	1800	—		V _{DS} = 25V
C _{rss}	Reverse Transfer Capacitance	—	880	—		f = 1.0MHz, See Fig. 5 ^⑤

Source-Drain Ratings and Characteristics

	Parameter	Min.	Typ.	Max.	Units	Conditions
I _S	Continuous Source Current (Body Diode)	—	—	179 ^⑥	A	MOSFET symbol showing the integral reverse p-n junction diode.
I _{SM}	Pulsed Source Current (Body Diode) ^①	—	—	720		
V _{SD}	Diode Forward Voltage	—	—	1.3	V	T _J = 25°C, I _S = 71A, V _{GS} = 0V ^④
t _{rr}	Reverse Recovery Time	—	120	180	ns	T _J = 25°C, I _F = 71A
Q _{rr}	Reverse Recovery Charge	—	450	680	nC	di/dt = 100A/μs ^{④⑤}
t _{on}	Forward Turn-On Time	Intrinsic turn-on time is negligible (turn-on is dominated by L _S +L _D)				

Notes:

- ① Repetitive rating; pulse width limited by max. junction temperature. (See fig. 11)
- ② V_{DD} = 15V, starting T_J = 25°C, L = 180μH
R_G = 25Ω, I_{AS} = 71A. (See Figure 12)
- ③ I_{SD} ≤ 71A, di/dt ≤ 130A/μs, V_{DD} ≤ V_{(BR)DSS},
T_J ≤ 175°C

- ④ Pulse width ≤ 300μs; duty cycle ≤ 2%.

- ⑤ Uses IRL3803 data and test conditions.

- ⑥ Calculated continuous current based on maximum allowable junction temperature; for recommended current-handling of the package refer to Design Tip # 93-4

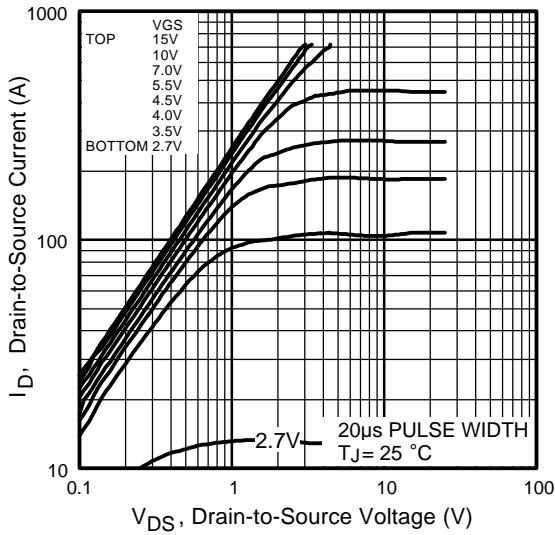

Fig 1. Typical Output Characteristics

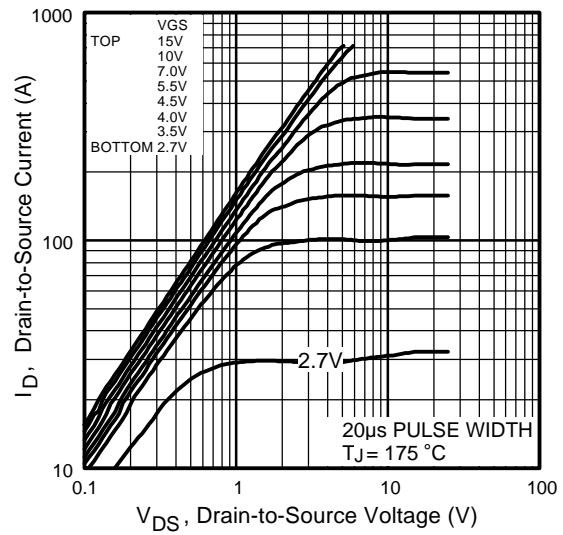

Fig 2. Typical Output Characteristics

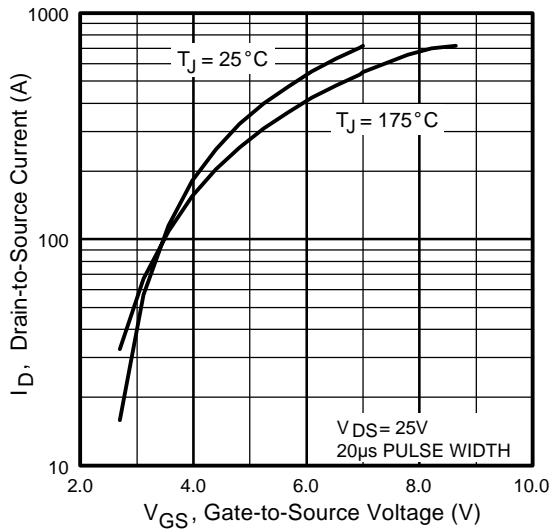

Fig 3. Typical Transfer Characteristics

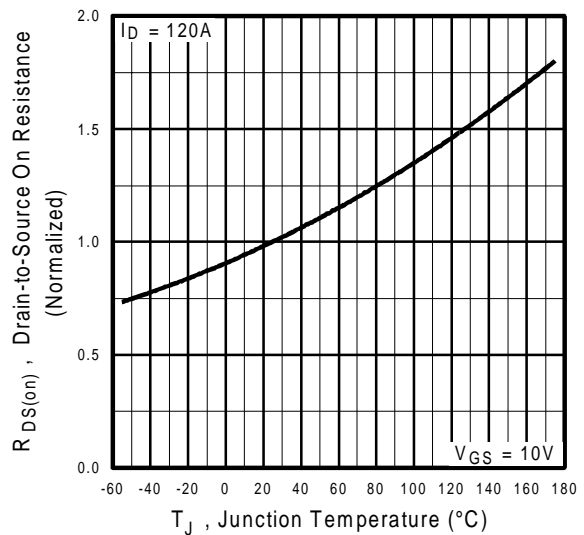

Fig 4. Normalized On-Resistance Vs. Temperature

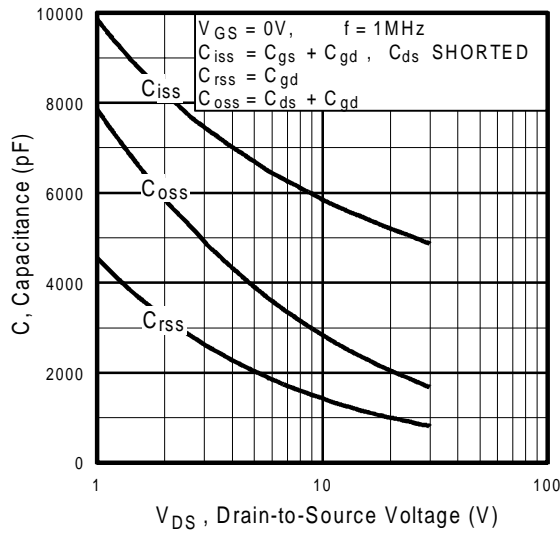

Fig 5. Typical Capacitance Vs. Drain-to-Source Voltage

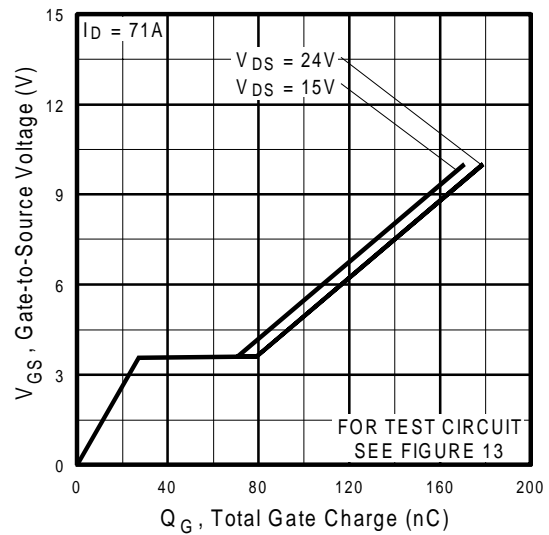

Fig 6. Typical Gate Charge Vs. Gate-to-Source Voltage

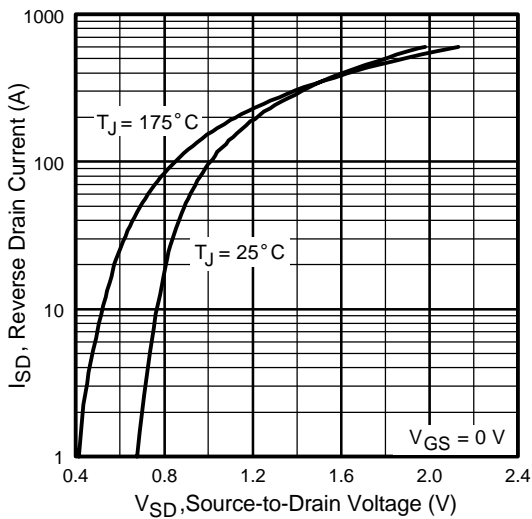

Fig 7. Typical Source-Drain Diode Forward Voltage

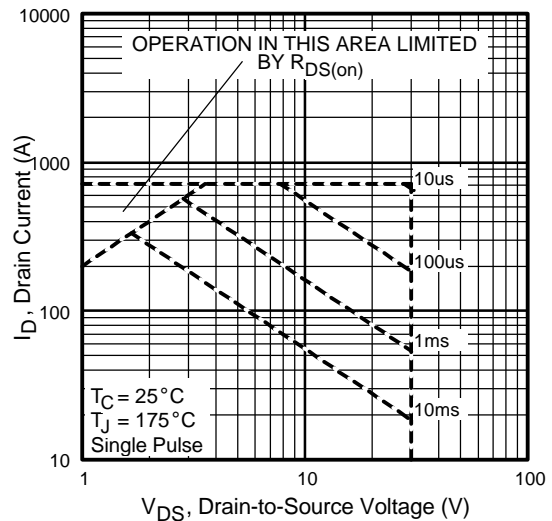

Fig 8. Maximum Safe Operating Area

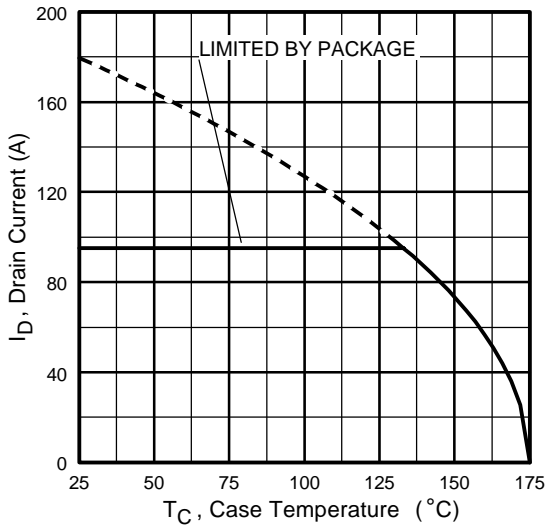

Fig 9. Maximum Drain Current Vs. Case Temperature

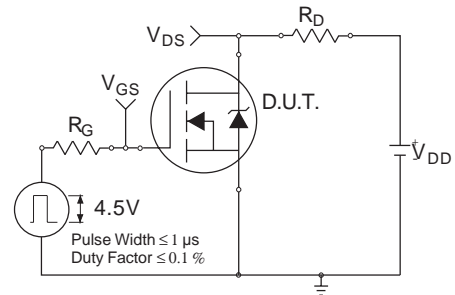

Fig 10a. Switching Time Test Circuit

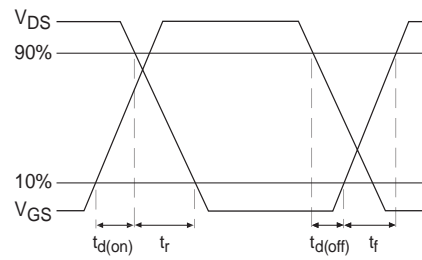

Fig 10b. Switching Time Waveforms

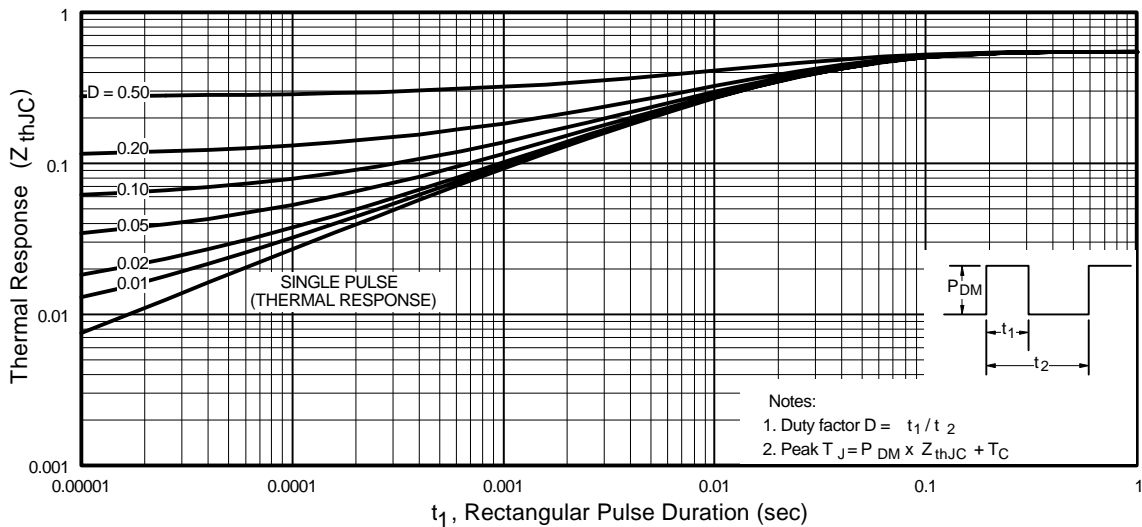

Fig 11. Maximum Effective Transient Thermal Impedance, Junction-to-Case

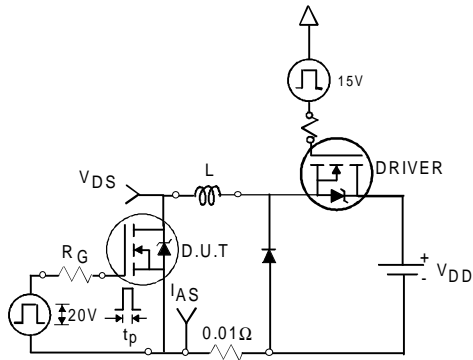

Fig 12a. Unclamped Inductive Test Circuit

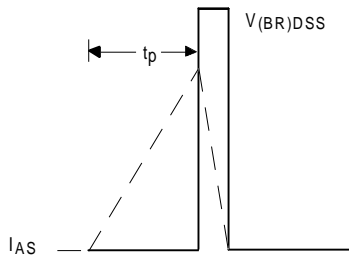

Fig 12b. Unclamped Inductive Waveforms

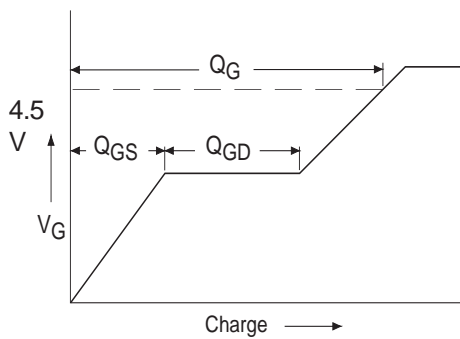

Fig 13a. Basic Gate Charge Waveform

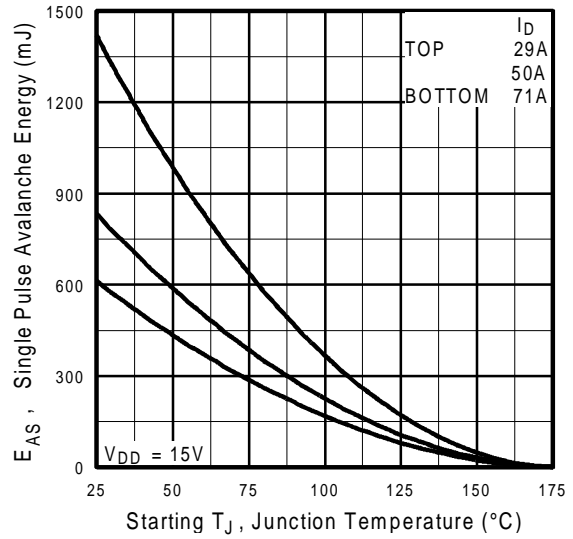

Fig 12c. Maximum Avalanche Energy Vs. Drain Current

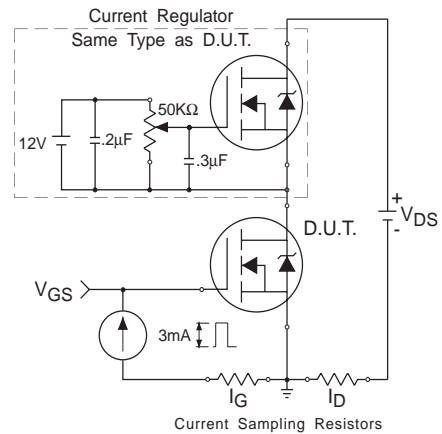
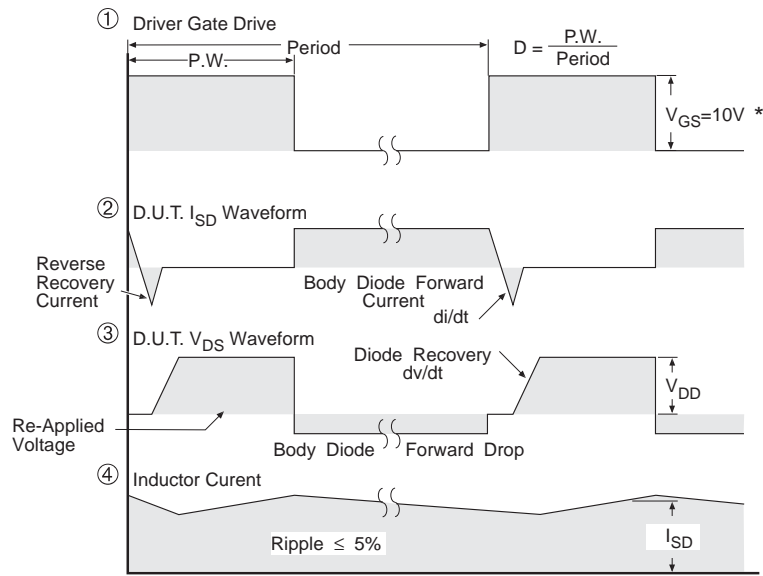
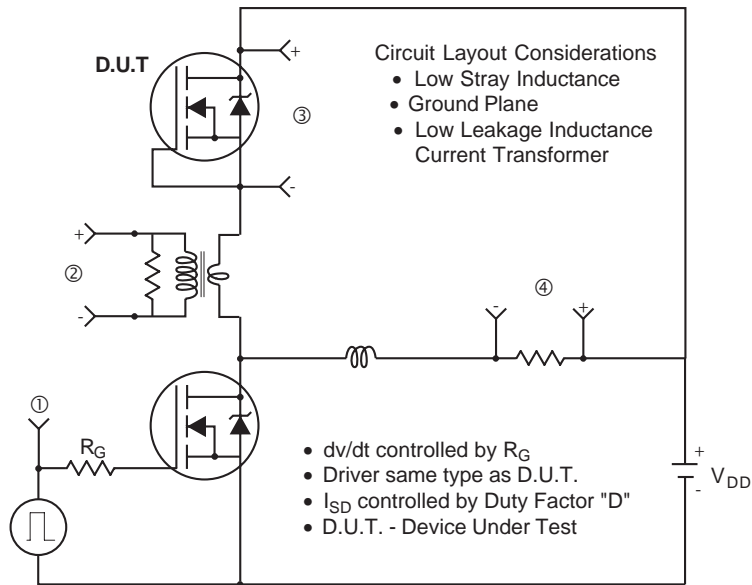

Fig 13b. Gate Charge Test Circuit

Peak Diode Recovery dv/dt Test Circuit



* $V_{GS} = 5V$ for Logic Level Devices

Fig 14. For N-Channel HEXFETS

IRLBA3803

International
IR Rectifier

Super-220 Package Outline

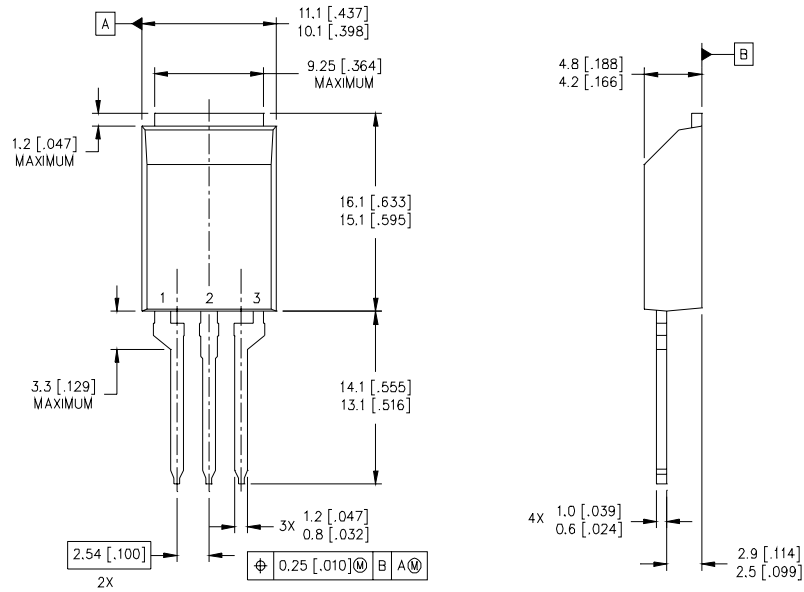

Super-220 package is not recommended for Surface Mount Application.

Data and specifications subject to change without notice.
This product has been designed and qualified for the Consumer market.
Qualification Standards can be found on IR's Web site.

International
IR Rectifier

IR WORLD HEADQUARTERS: 233 Kansas St., El Segundo, California 90245, USA Tel: (310) 252-7105
TAC Fax: (310) 252-7903

Visit us at www.irf.com for sales contact information.05/02

This datasheet has been download from:

www.datasheetcatalog.com

Datasheets for electronics components.