

DIAGRAMA AMPLIFICADOR ORIENTAL SUPER DRIVER 1500W

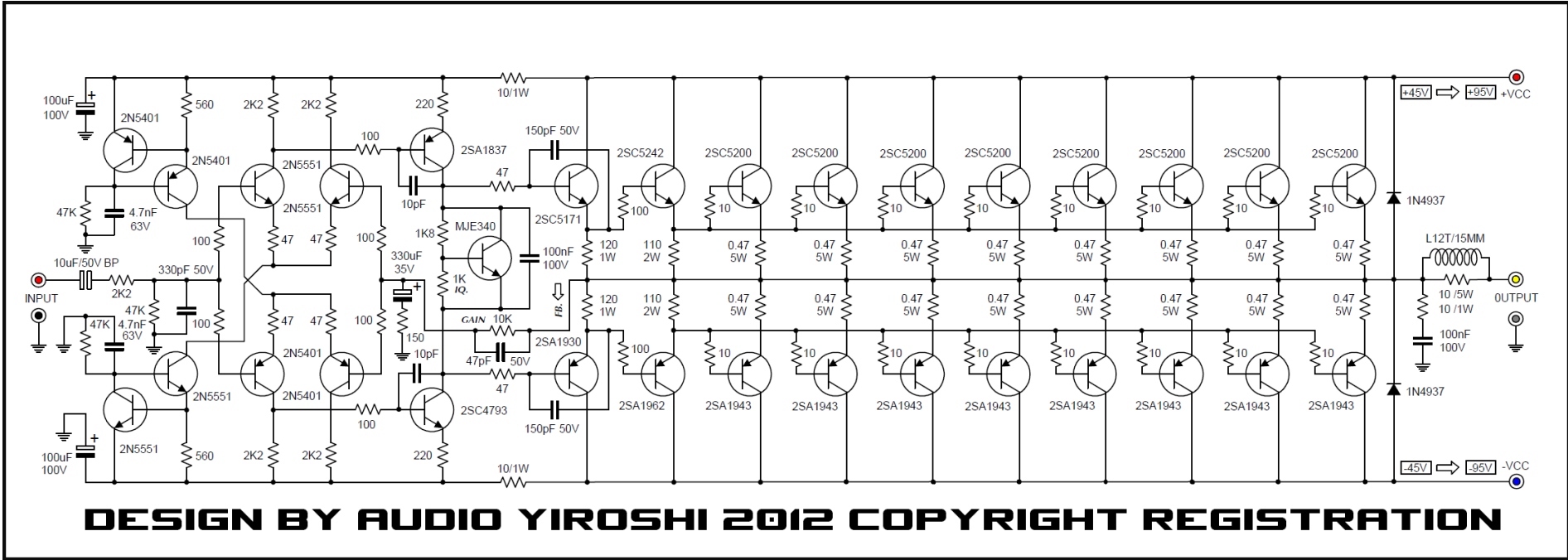

AUDIO YIROSHI

專業音頻功率放大器

PCB SUPER DRIVER 1200W SERIGRAFIA FINAL

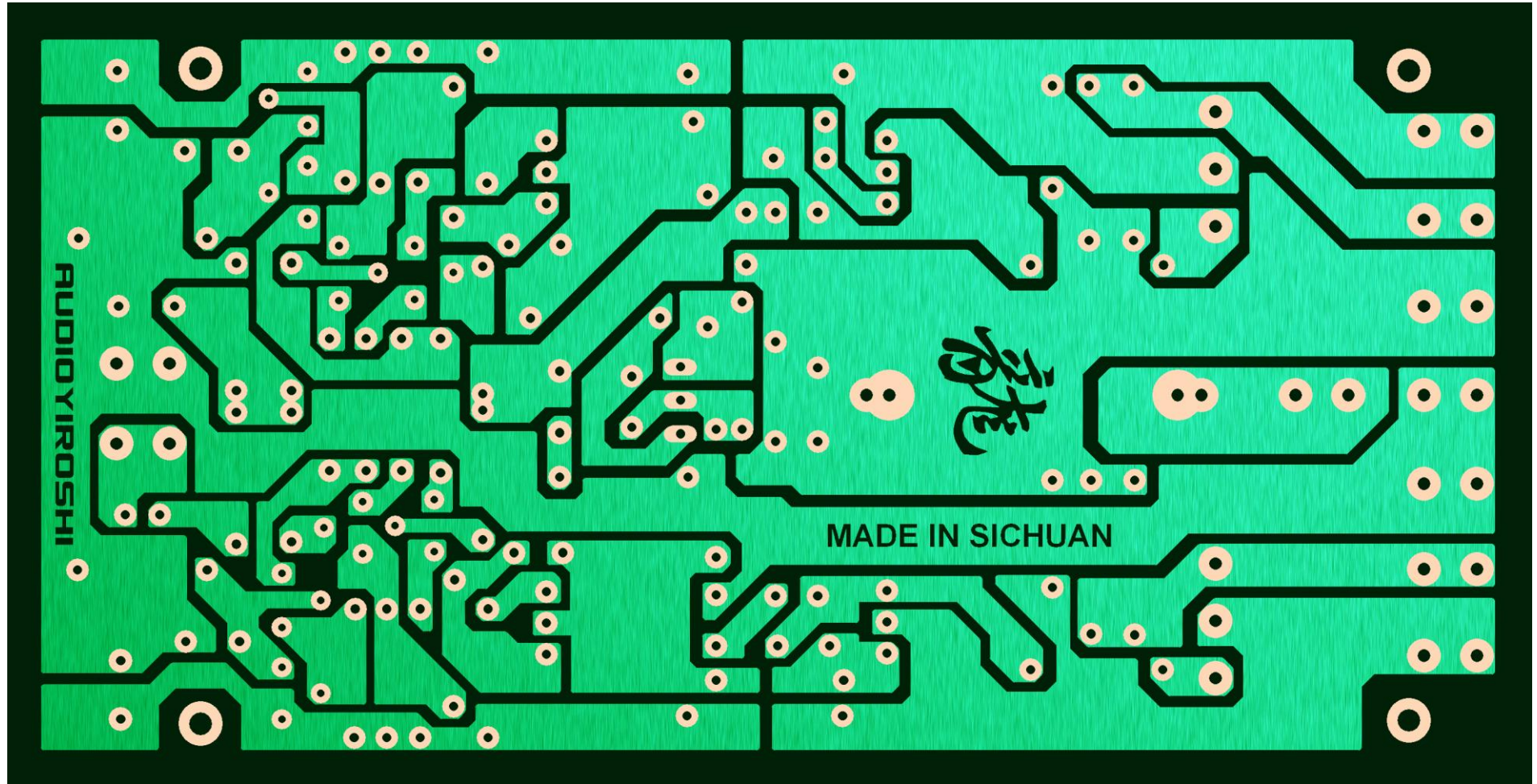

AUDIO YIROSHI
專業音頻功率放大器

SUPER DRIVER MASCARA DE COMPONENTES MODO SERIGRAFIA

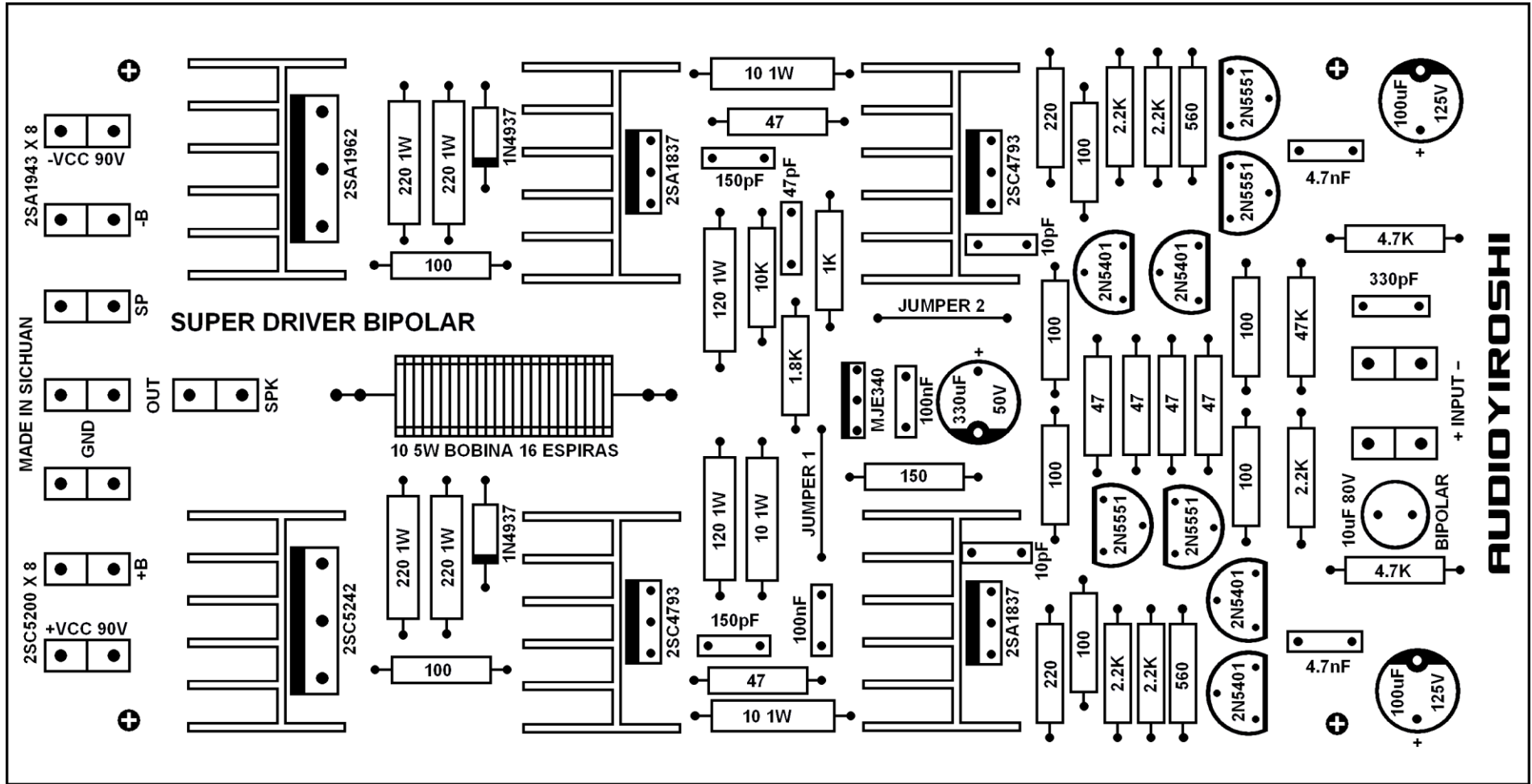

AUDIO YIROSHI

專業音頻功率放大器

SUPER DRIVER MASCARA DE COMPONENTES MODO TERMOTRANSFERENCIA

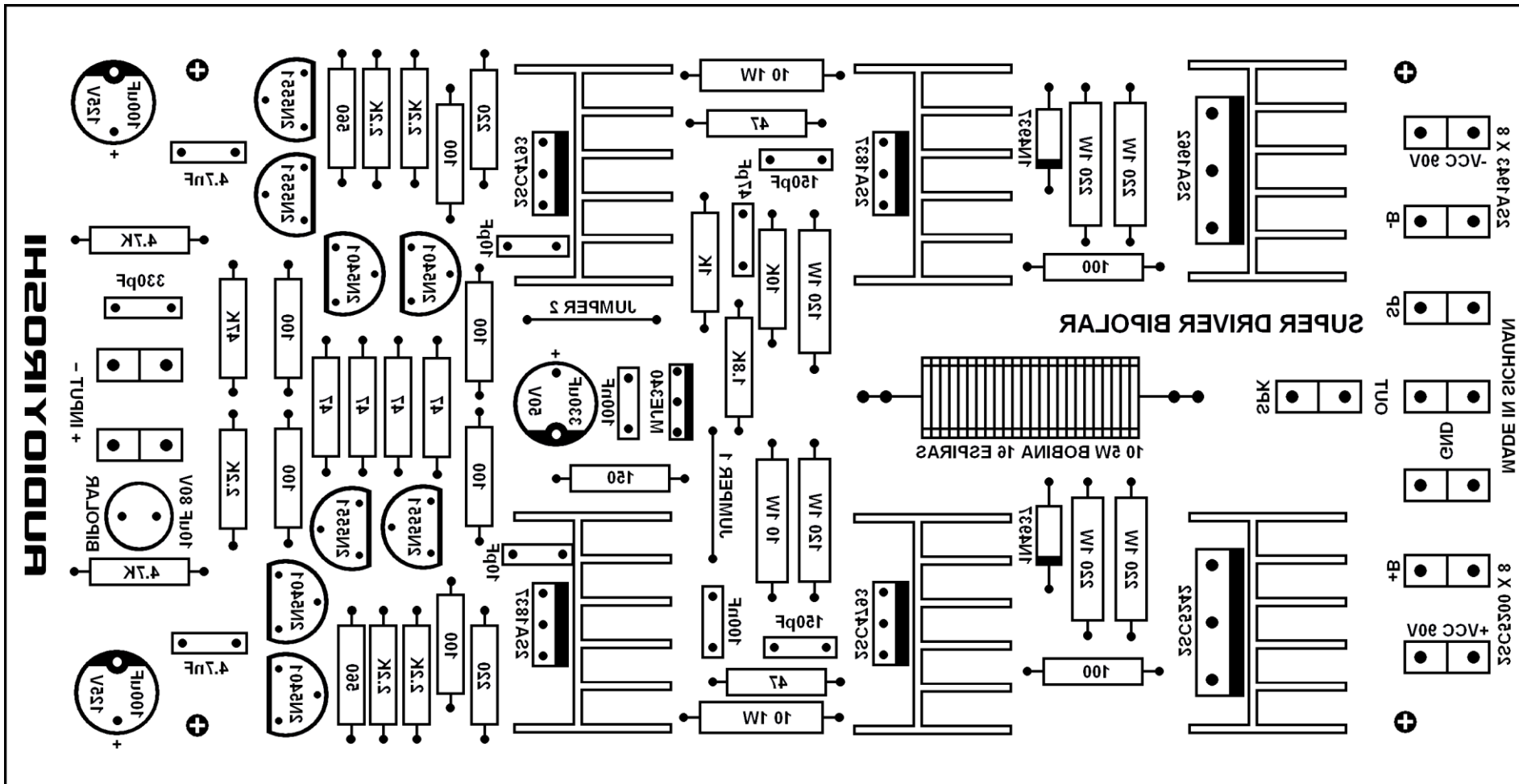

AUDIO YIROSHI

專業音頻功率放大器

PCB SUPER DRIVER BIPOLAR MODO SERIGRAFIA

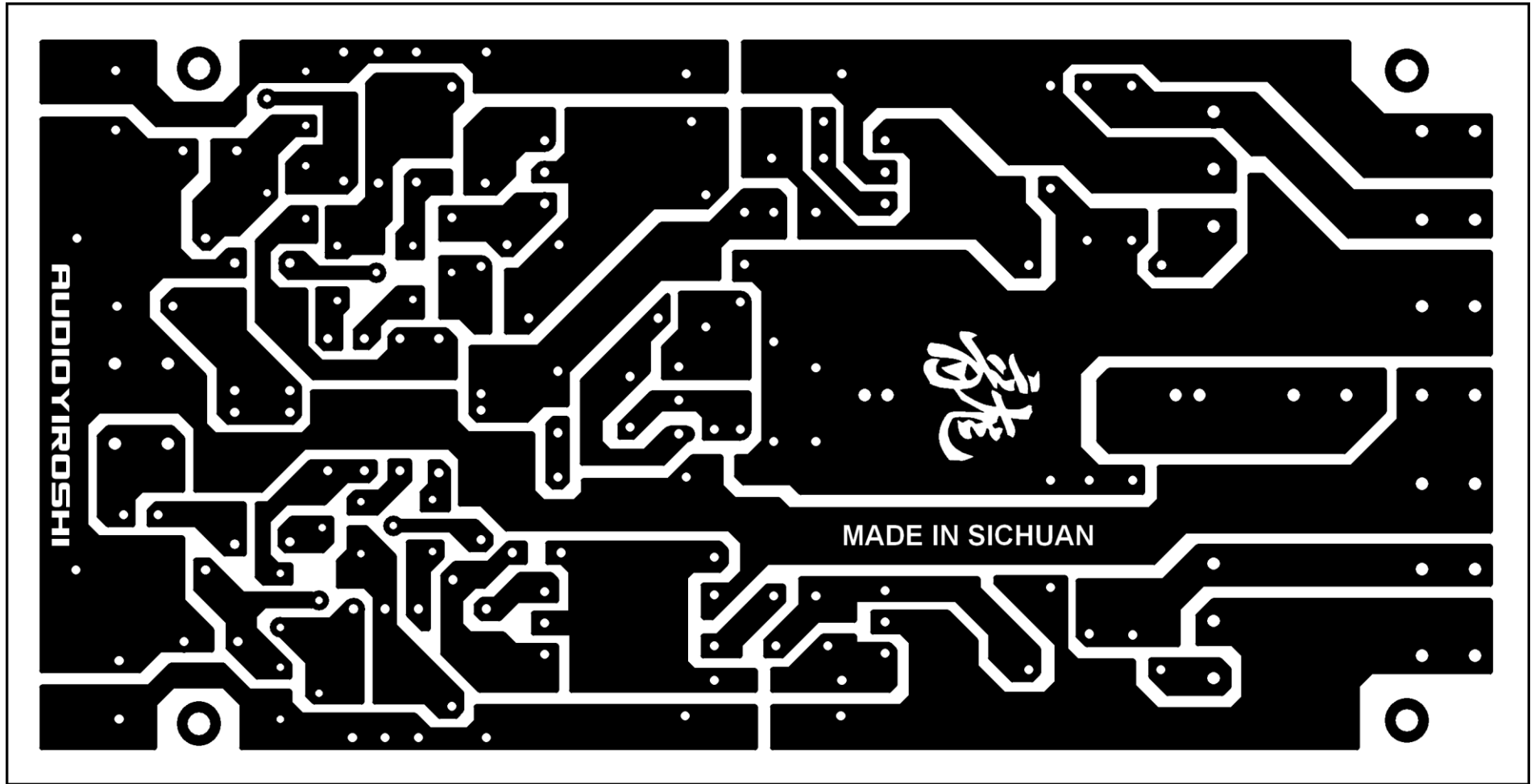

AUDIO YIROSHI
專業音頻功率放大器

PCB SUPER DRIVER MODO TERMOTRANSFERENCIA

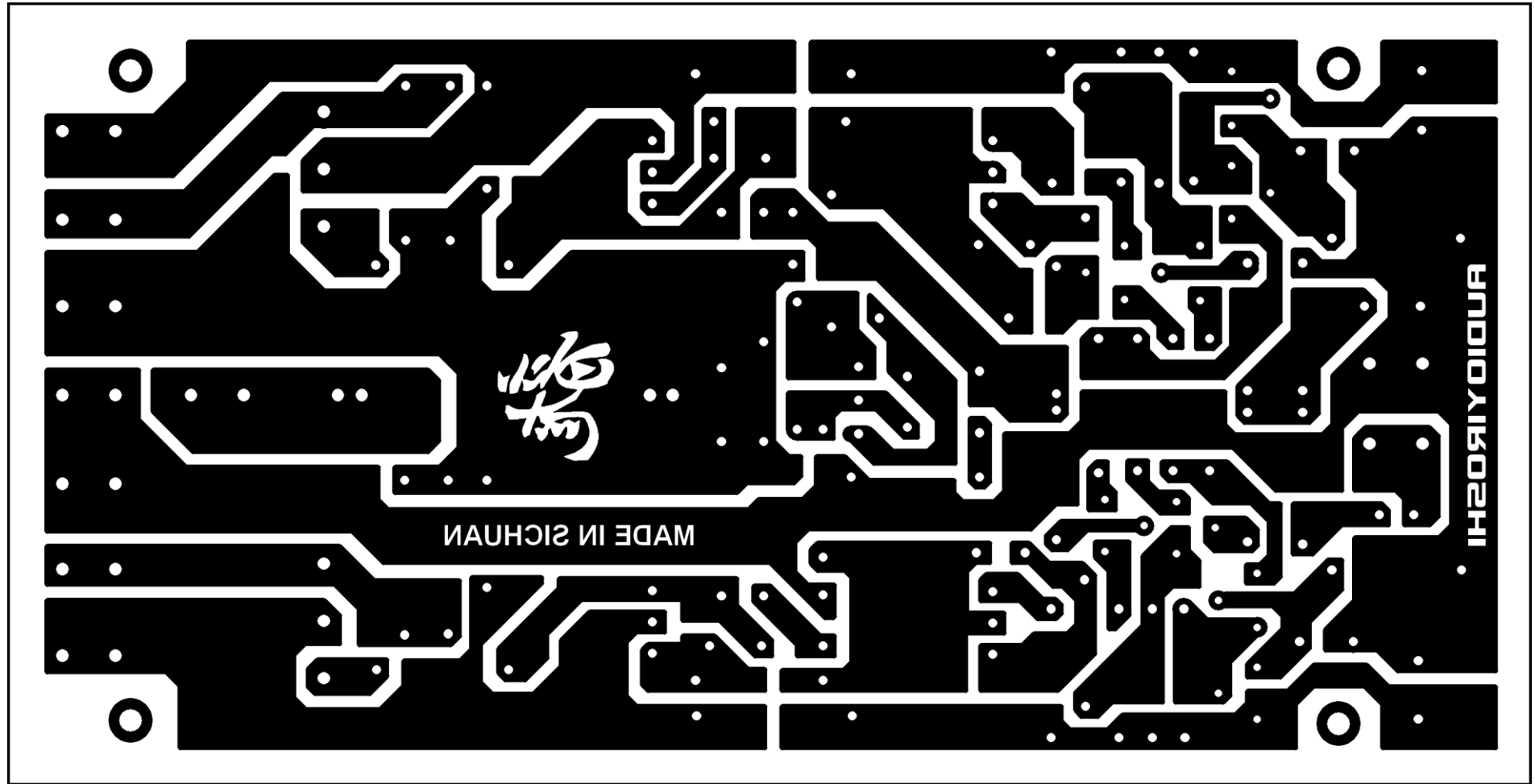

AUDIO YIROSHI
專業音頻功率放大器

PCB ETAPA DE SALIDA DE 600W 1200W SERIGRAFIA FINAL

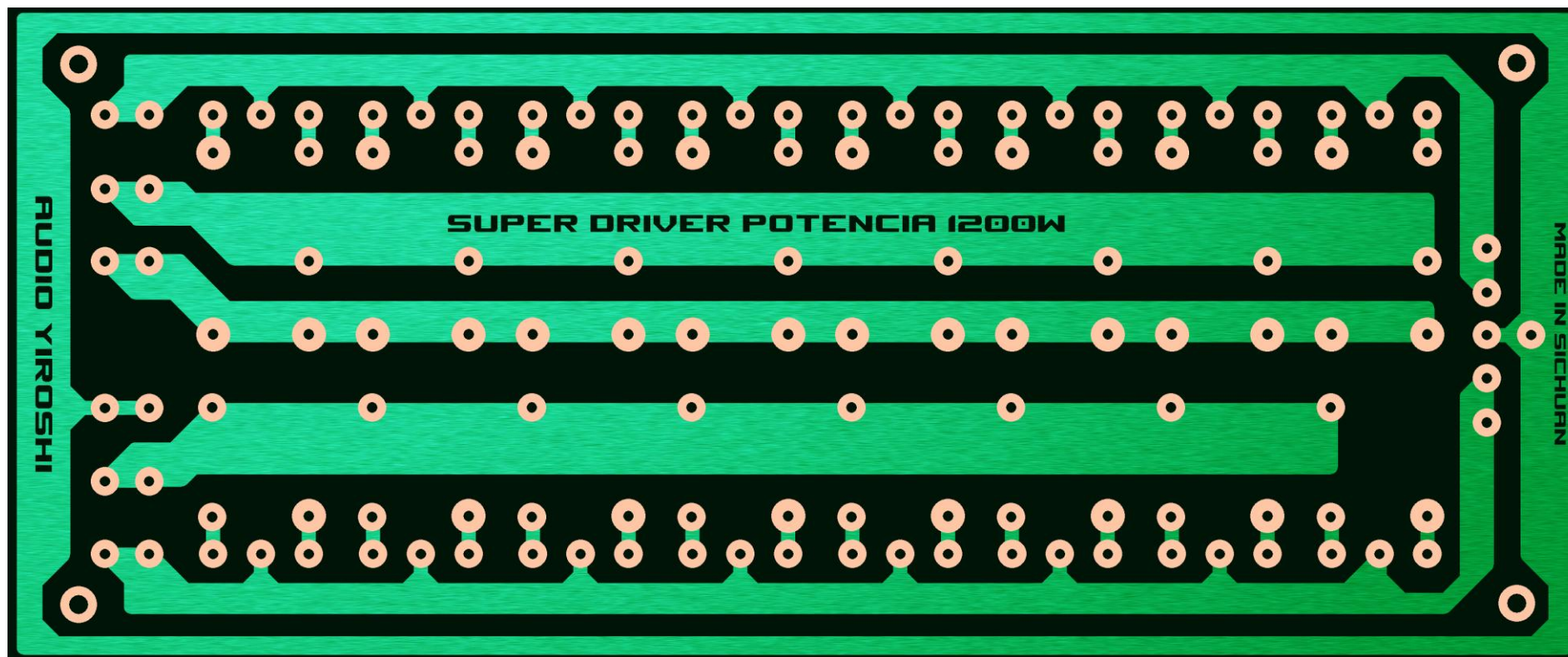

MEDIDAS DE LA PLACA REAL ETAPA DE POTENCIA 6.5cm x 15.5cm

POTENCIAS DE 600W<>1200W CON 16 TRANSISTORES COMPLEMENTARIOS

IMPEDANCIAS DE 8 Ohm<>2 Ohm

SALIDA INTEGRADA DE ALIMENTACION

ETAPA DE POTENCIA PX 1200 GUIA DE COMPONENTES

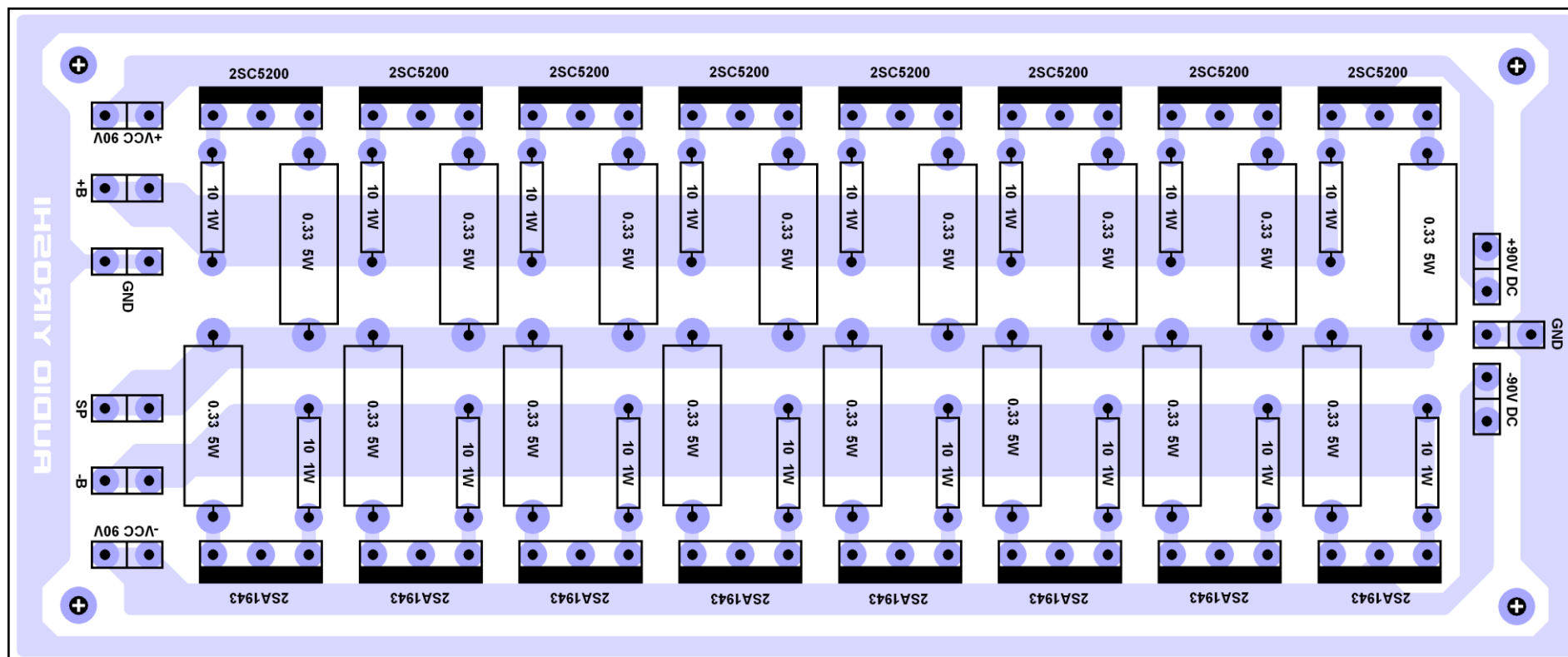

AUDIO YIROSHI
專業音頻功率放大器

MASCARA DE COMPONENTES PX 1200 MODO SERIGRAFIA

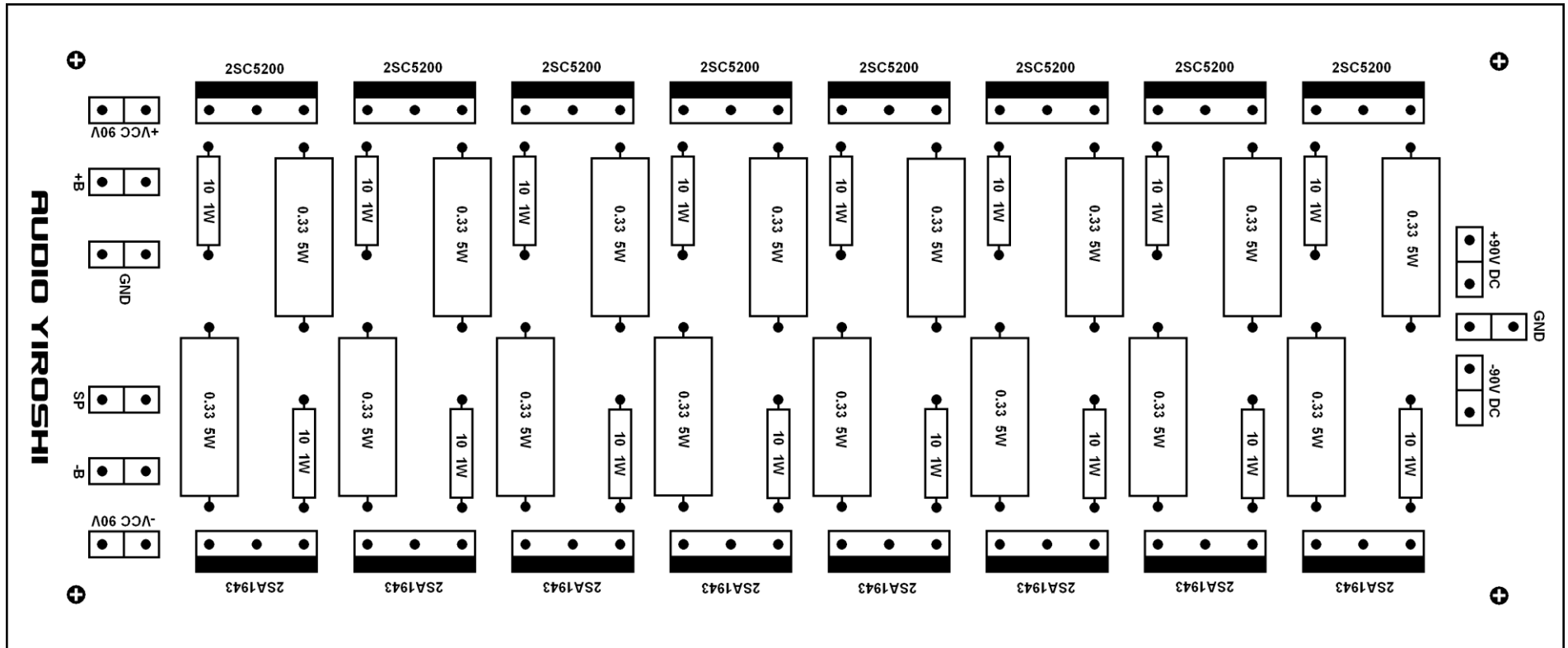

AUDIO YIROSHI

專業音頻功率放大器

MASCARA DE COMPONENTES PX 1200 MODO TERMOTRANSFERENCIA

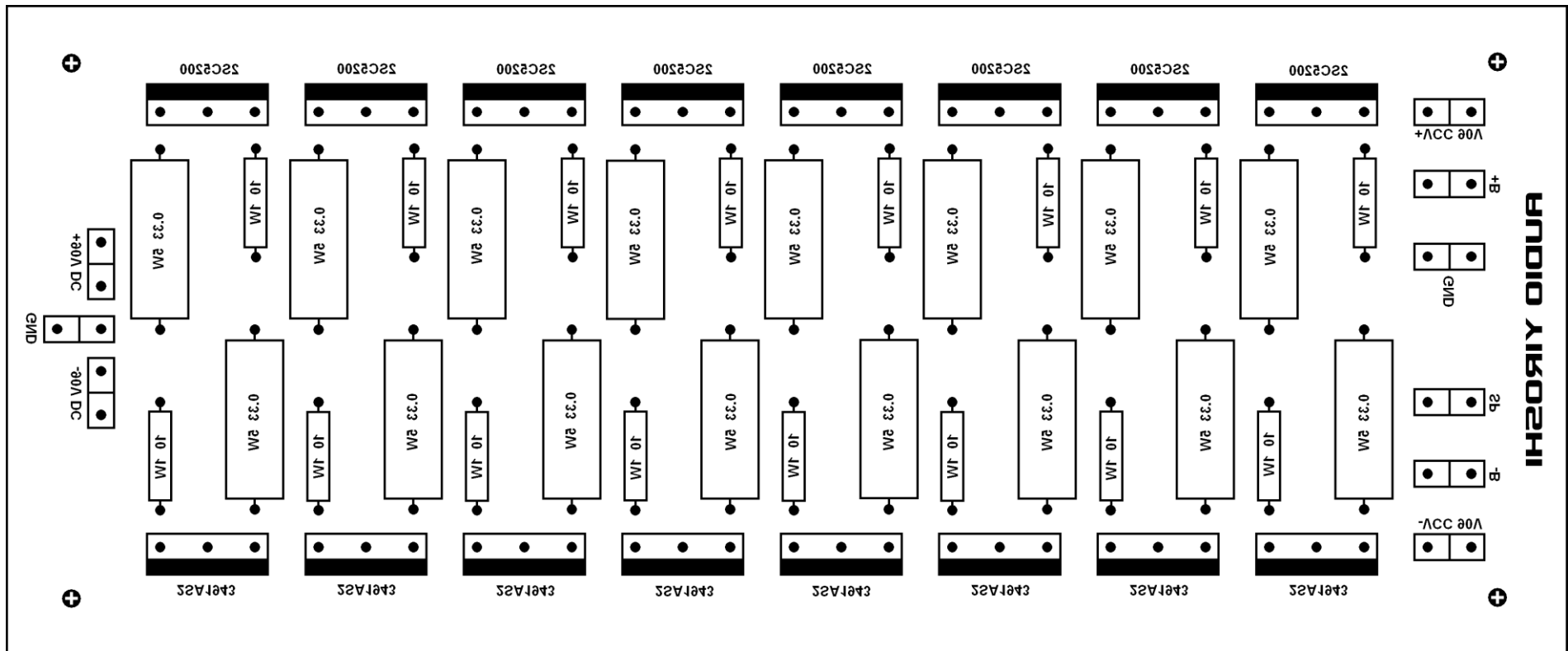

AUDIO YIROSHI

專業音頻功率放大器

PCB PX 1200 MODO SERIGRAFIA

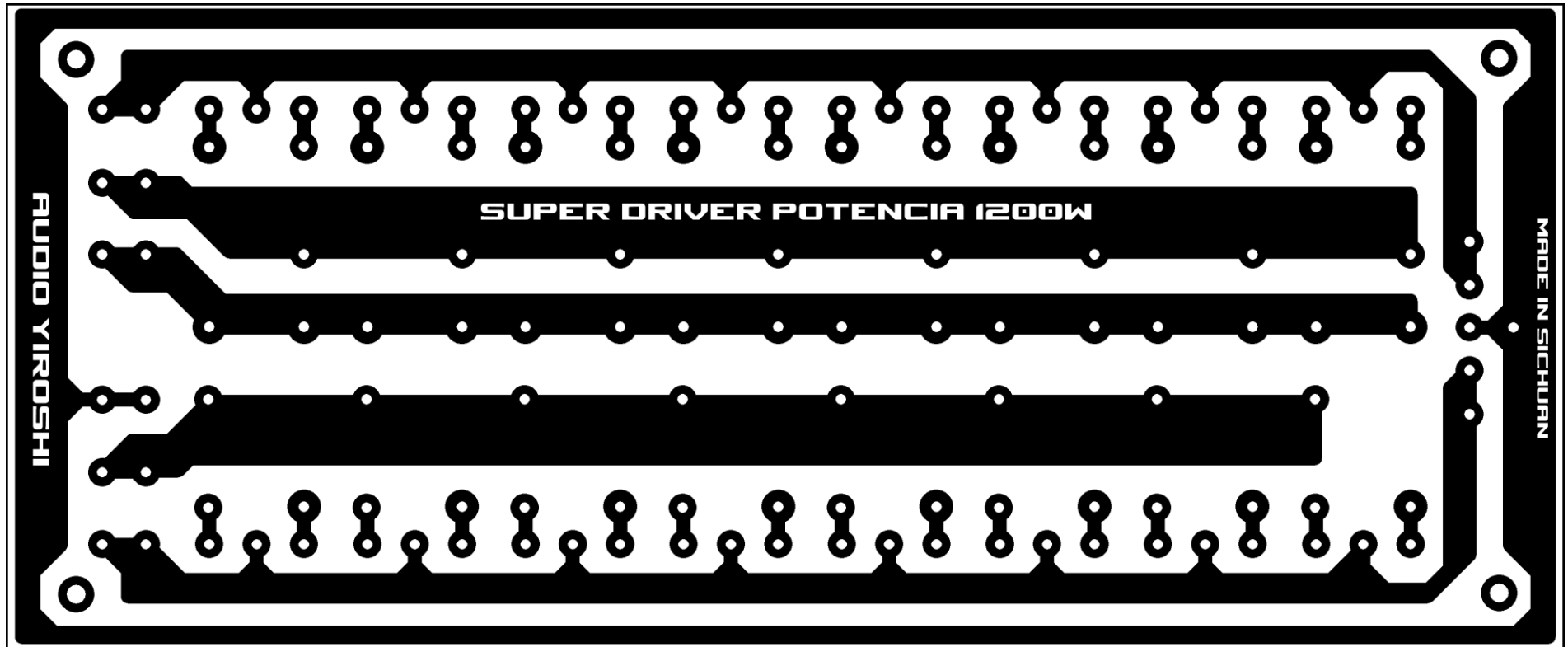

AUDIO YIROSHI
專業音頻功率放大器

PCB PX 1200 MODO TERMOTRANSFERENCIA

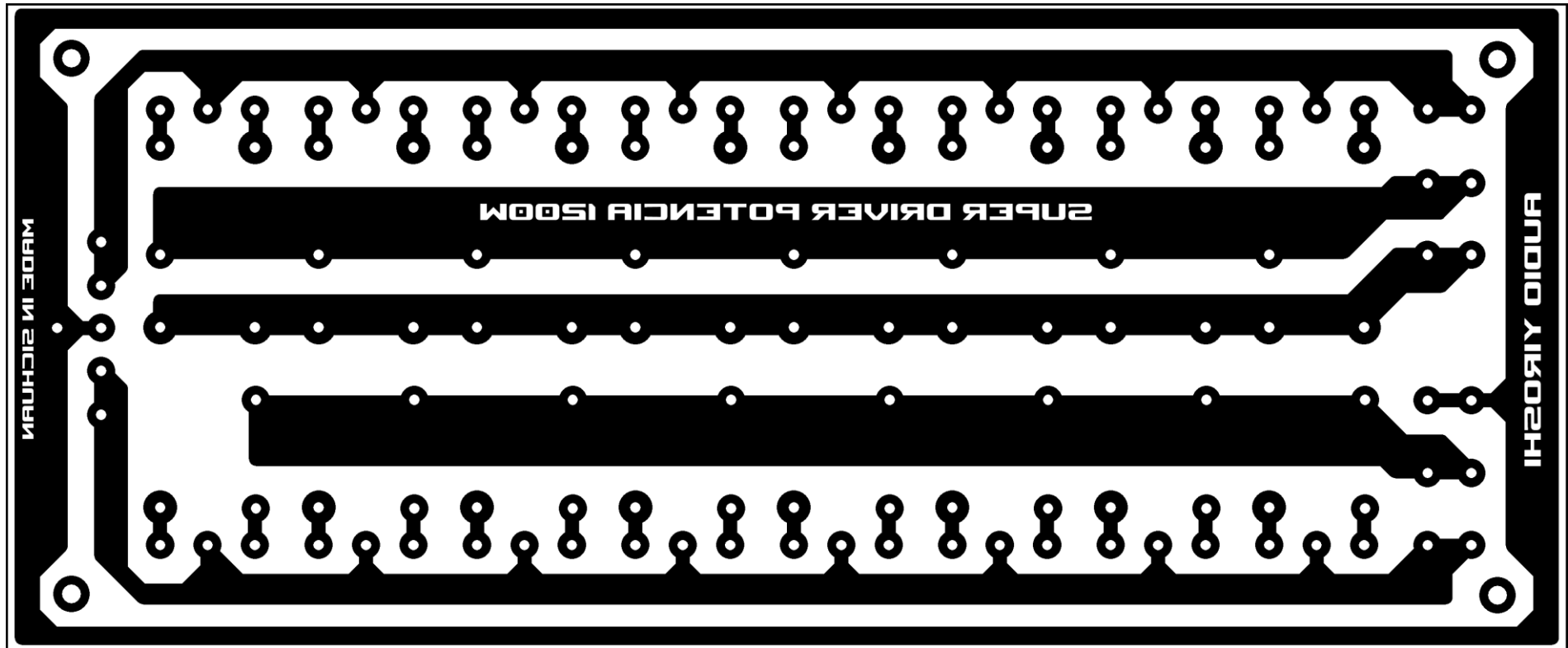

AUDIO YIROSHI
專業音頻功率放大器

PCB POWER SUPPLY PS 3000 SERIGRAFIA FINAL

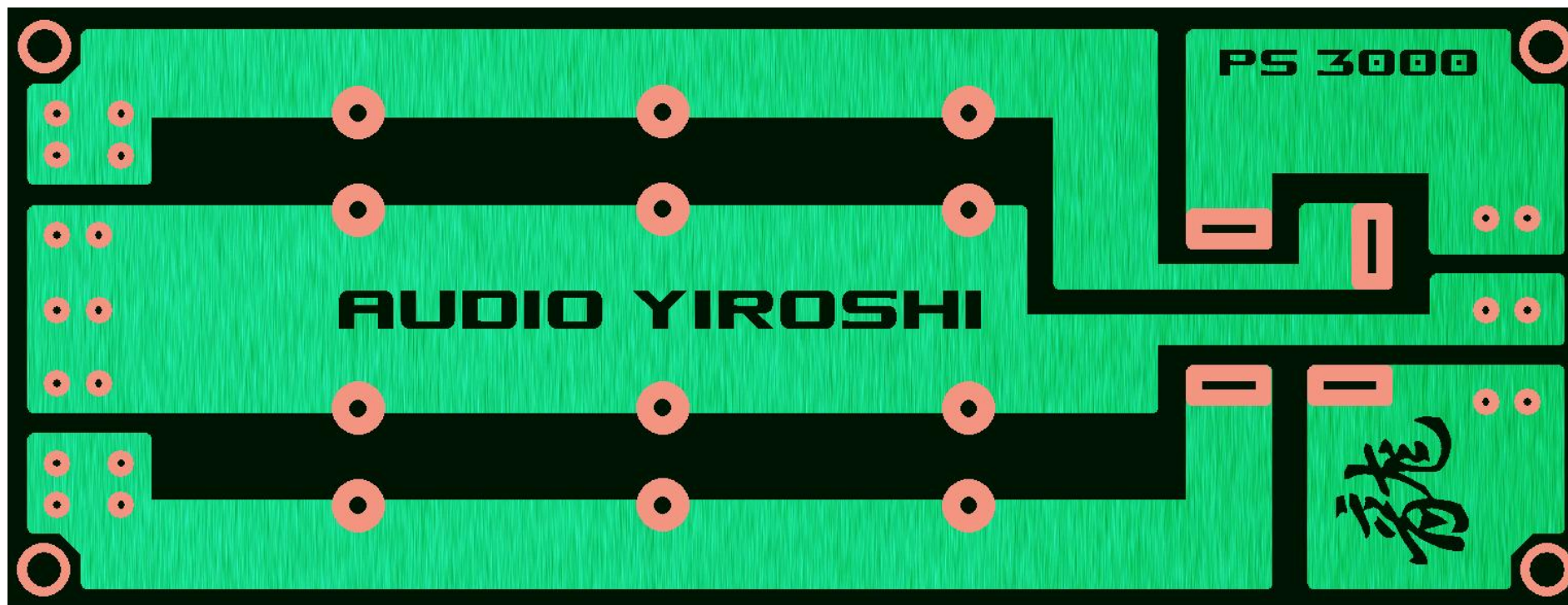

MEDIDAS DE LA PLACA REAL PS 3000 6.5cm x 16.5cm

PUENTE RECTIFICADOR 30AMP 400V

6 CONDENSADORES INTEGRADOS DE 4.700uF<>10.000uF 125V

TOROIDAL DE 40V 0 40V<>80V 0 80V

GUIA DE COMPONENTES FUENTE DE ALIMENTACION PS 3000

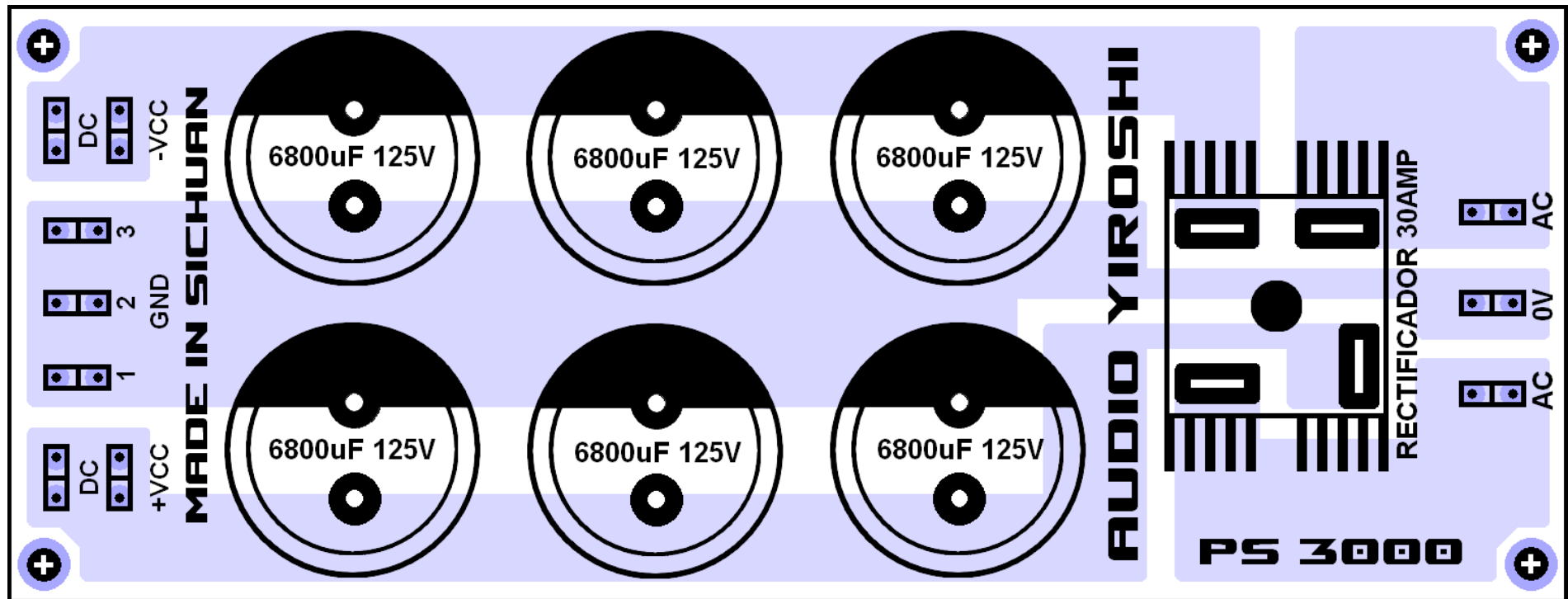

AUDIO YIROSHI

專業音頻功率放大器

MASCARA DE COMPONENTES PS 3000 MODO SERIGRAFIA

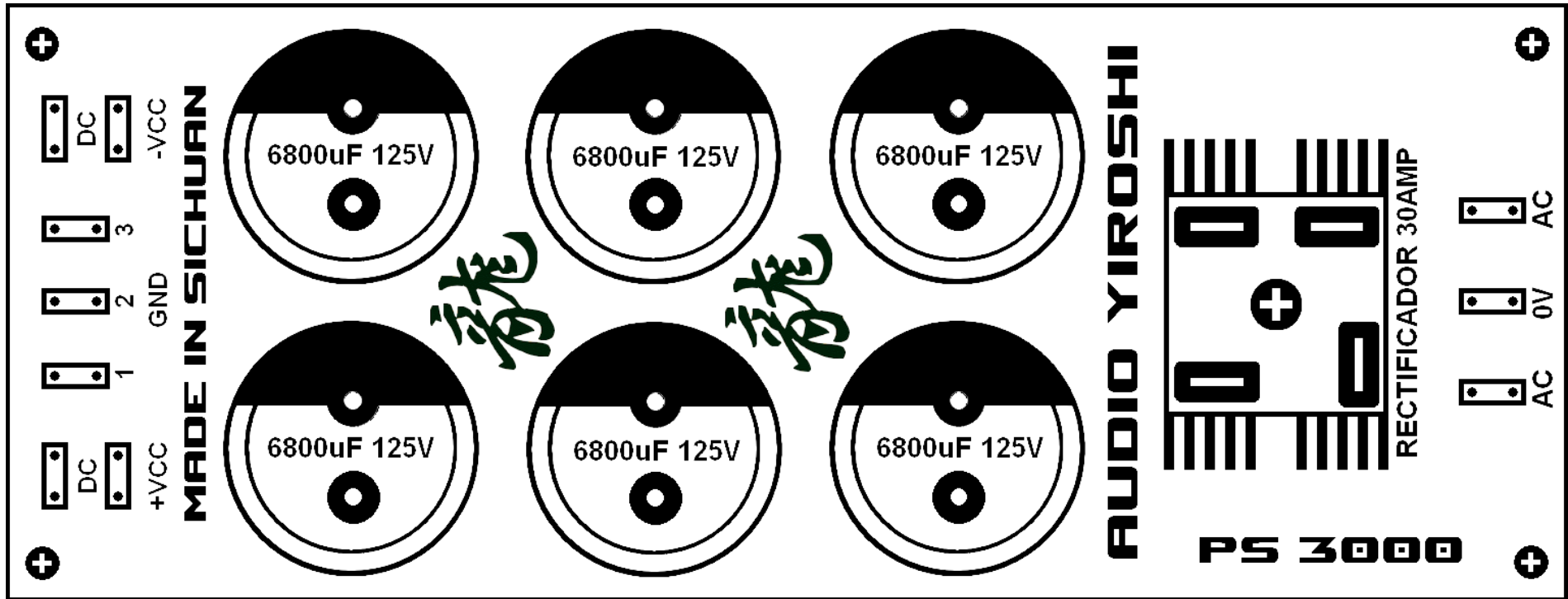

AUDIO YIROSHI
專業音頻功率放大器

MASCARA DE COMPONENTES PS 3000 MODO TERMOTRANSFERENCIA

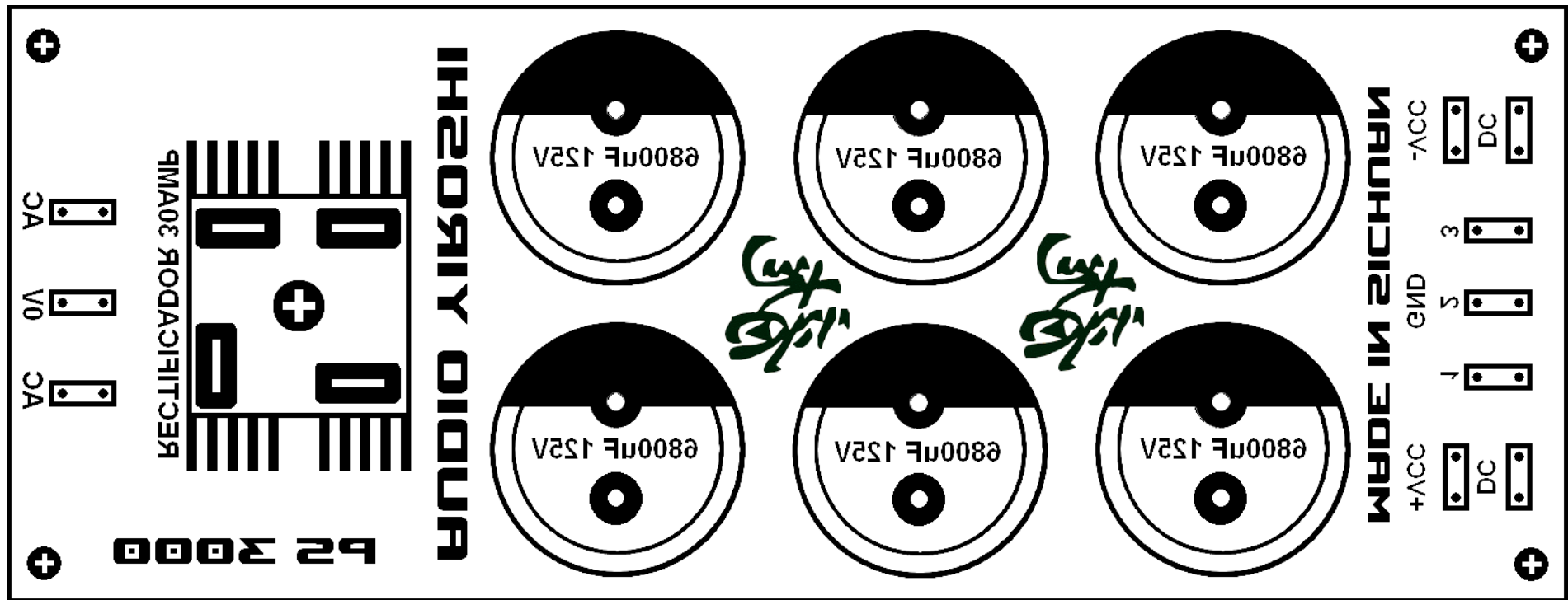

AUDIO YIROSHI

專業音頻功率放大器

PCB PS 3000 MODO SERIGRAFIA

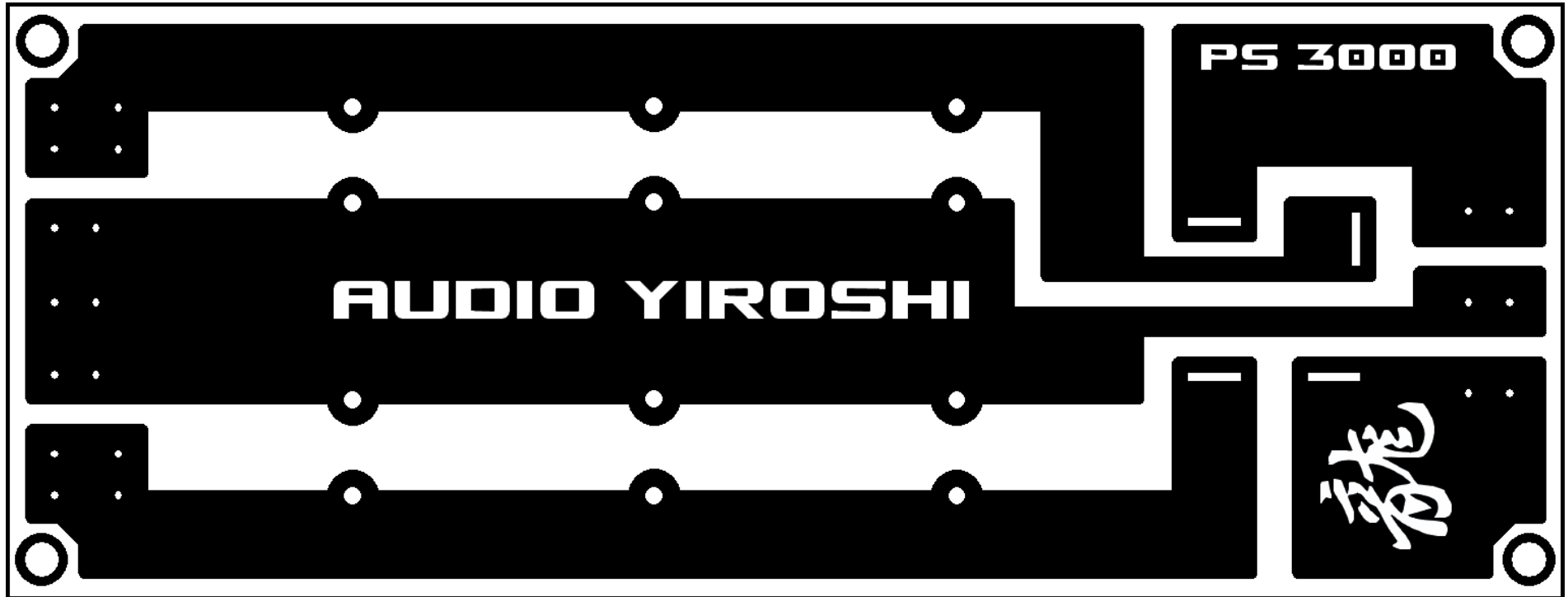

AUDIO YIROSHI
專業音頻功率放大器

PCB PS 3000 MODO TERMOTRANSFERENCIA

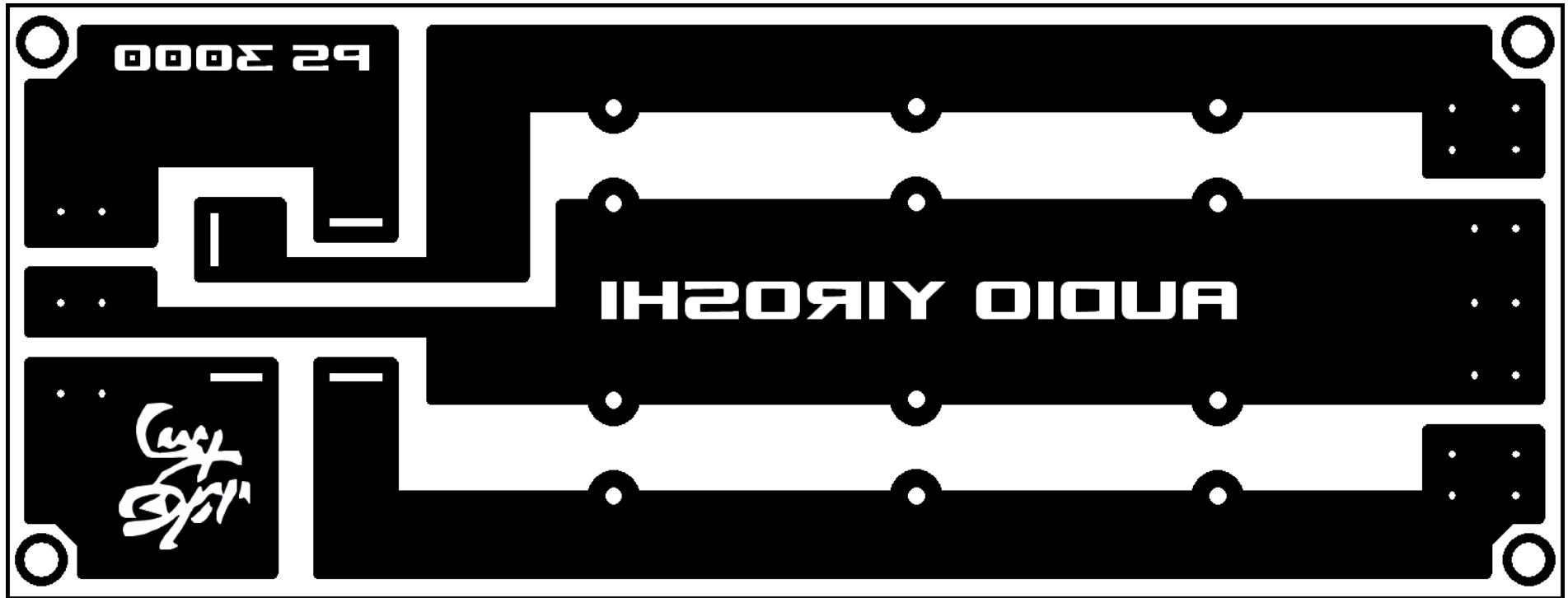

AUDIO YIROSHI
專業音頻功率放大器

GUIA DE CONEXION AMPLIFICADOR ORIENTAL TR 3500 MODO STEREO 3.000W

