

TA-212

*AEP Model
UK Model
E Model*



INTEGRATED STEREO AMPLIFIER

SPECIFICATIONS

GENERAL

Power Requirements:	220 V ac, 50 Hz (AEP model) 240 V ac, 50 Hz (UK model) 110, 120, 220 or 240 V ac adjustable, 50/60 Hz (E model)
Power Consumption:	73 W (AEP model) 83 W (UK model) 86 W (E model)
Dimensions:	Approx. 407 (w) x 150 (h) x 300 (d) mm 16 (w) x 5 7/8 (h) x 11 7/8 (d) inches including projecting parts and controls
Weight:	Approx. 5.1 kg, 11 lb 4 oz (net) 6.1 kg, 13 lb 7 oz (in shipping carton)

AMPLIFIER SECTION

System:	Direct output coupling, complementary Symmetry power amplifier circuit (SEPP OTL)
Continuous RMS Power Output: (Less than 3% THD, both channels driven simultaneously)	At 50 Hz – 16 kHz 12 + 12 W (8 Ω) At 1 kHz 15 + 15 W (8 Ω) According to DIN 45500 11 + 11 W (8 Ω)
Dynamic Power Output: (IHF constant power supply method)	52 W (8 Ω)
Power Bandwidth: (IHF)	40 Hz – 20 kHz (8 Ω)
Damping Factor:	20 at 1 kHz (8 Ω)

– Continued on page 2 –

SAFETY-RELATED COMPONENT WARNING !!

COMPONENTS IDENTIFIED BY SHADING AND MARK  ON THE SCHEMATIC DIAGRAMS, EXPLODED VIEWS AND IN THE PARTS LIST ARE CRITICAL TO SAFE OPERATION. REPLACE THESE COMPONENTS WITH SONY PARTS WHOSE PART NUMBERS APPEAR AS SHOWN IN THIS MANUAL OR IN SUPPLEMENTS PUBLISHED BY SONY.

SONY®

SERVICE MANUAL

Harmonic Distortion: Less than 3 % at rated output
 Less than 0.8 % at 1 W output

IM Distortion: Less than 3 % at rated output
 (60Hz : 7kHz = 4 : 1) Less than 0.8 % at 1 W output

Frequency Response: PHONO: RIAA equalization curve
 ± 1.5 dB
 MIC: 250 Hz – 9 kHz ± 3 dB

Residual Noise: Less than 0.29 μ W (8 Ω)

Inputs:

	Sensitivity	Impedance	Maximum input capability (1 % distortion, at 1 kHz)
PHONO	3 mV	47 k Ω	100 mV
MIC	3.8 mV	600 Ω	23 mV
TUNER TAPE	160 mV	47 k Ω	

Outputs:

REC OUT	voltage 140 mV	impedance 18 k Ω
SPEAKER	Accepts speaker of 8 Ω – 16 Ω	
HEADPHONES	Accepts headphones of 8 Ω or more	



Tone Controls: BASS: ± 7.5 dB at 100 Hz
 TREBLE: ± 7.5 dB at 10 kHz

Loudness: +7 dB at 50 Hz



MODEL IDENTIFICATION

– Specification Label –



AEP model

 	INTEGRATED STEREO AMPLIFIER MODEL NO. TA-212 AC 220V \sim 50Hz 73W MADE IN TAIWAN REPUBLIC OF CHINA
	<div style="border: 1px solid black; padding: 2px; display: inline-block;">SERIAL NO.</div>

UK model

 	INTEGRATED STEREO AMPLIFIER MODEL NO. TA-212 AC 240V \sim 50Hz 83W MADE IN TAIWAN REPUBLIC OF CHINA
	<div style="border: 1px solid black; padding: 2px; display: inline-block;">SERIAL NO.</div>

E model

 	INTEGRATED STEREO AMPLIFIER MODEL NO. TA-212 AC 110, 120, 220, 240V \sim 50/60Hz 86W MADE IN TAIWAN REPUBLIC OF CHINA
	<div style="border: 1px solid black; padding: 2px; display: inline-block;">SERIAL NO.</div>

1-1. BLOCK DIAGRAM

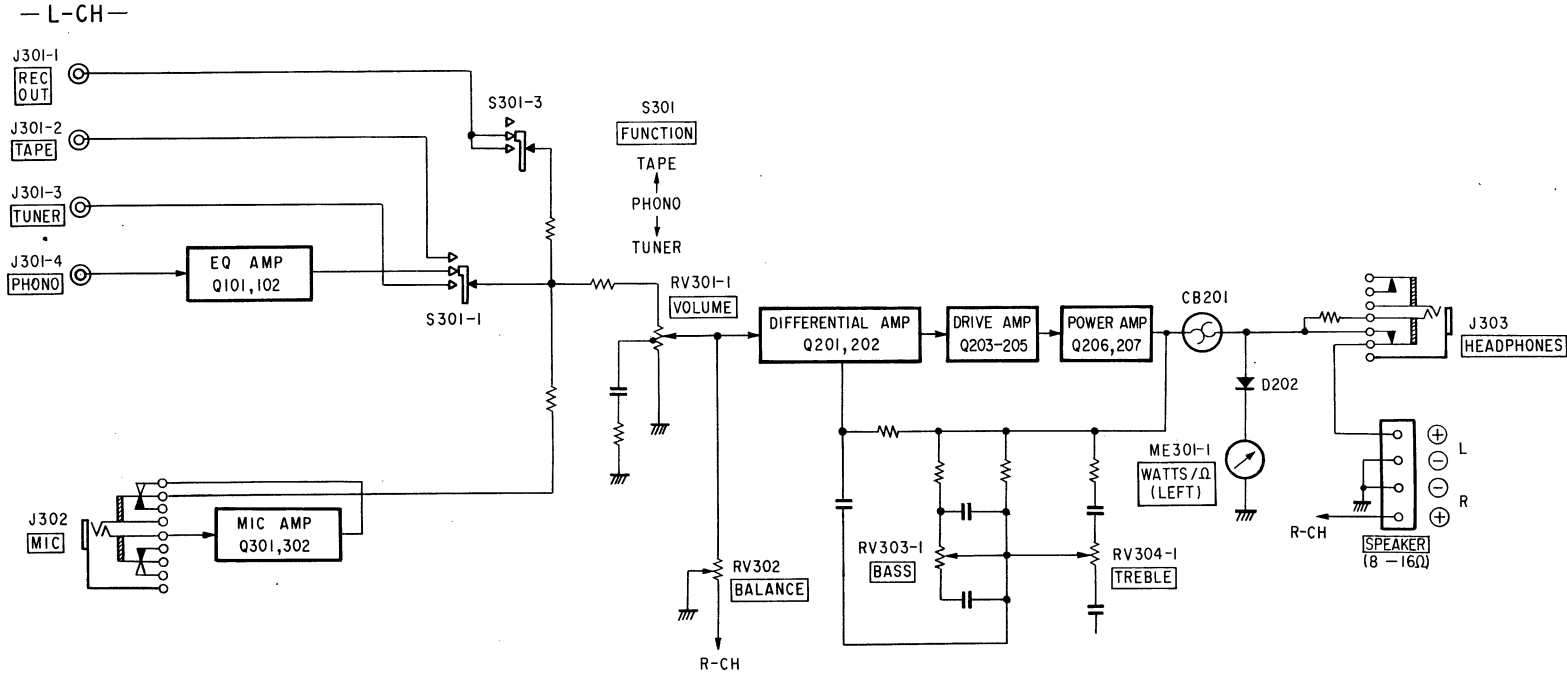

— R-CH —
(SAME AS L-CH)

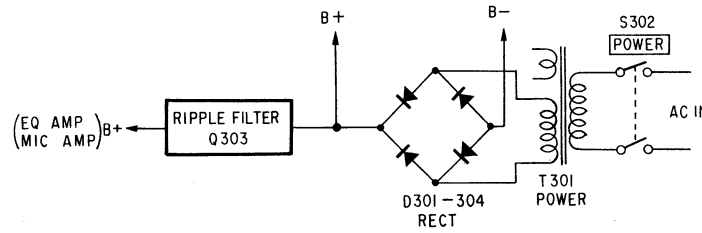

SECTION 1
OUTLINE

SECTION 2 DISASSEMBLY AND REPLACEMENT

- Follow the disassembly procedure in the numerical order given.

Top Cover Removal

- Remove six screws.



• CIRCUIT BOARD CHECK

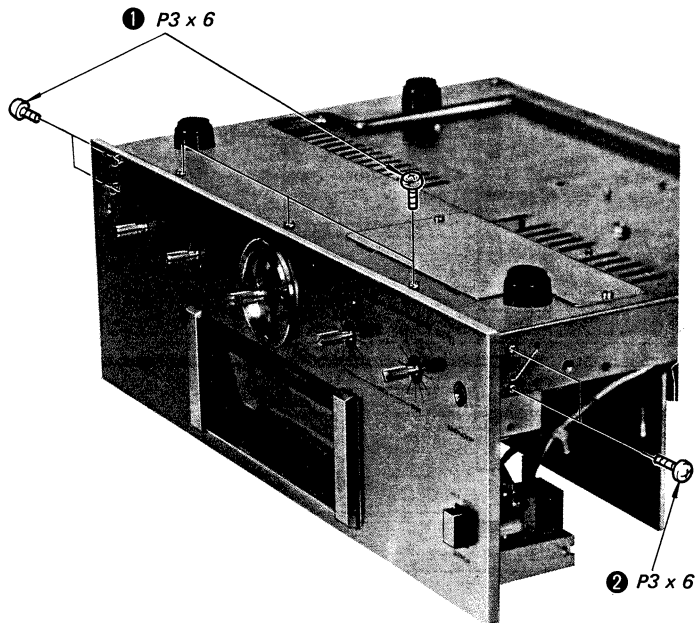

- 4 Turn the power amp and preamp circuit boards over.

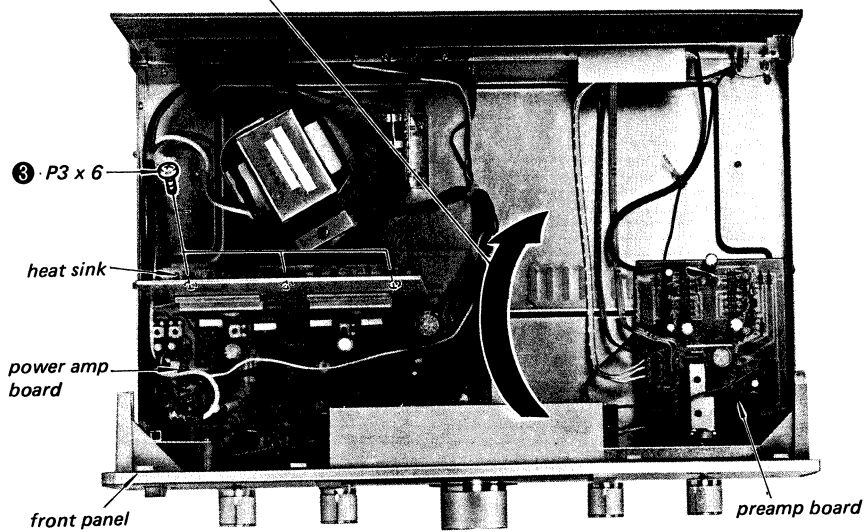

- 5 The power amp and preamp circuit boards can be checked.

SECTION 3 ADJUSTMENT

Power Meter Adjustment

Setting: VOLUME control: fully clockwise
 BASS control: fully clockwise
 TREBLE control: fully clockwise
 FUNCTION switch: TAPE
 BALANCE control: mechanical mid

Procedure:

1.

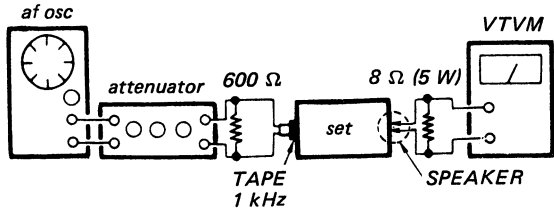

2. Adjust attenuator for 4V (2W) reading on VTVM.
3. Adjust RV202 (L-CH) and RV252 (R-CH) so that power meters indicate 2W.

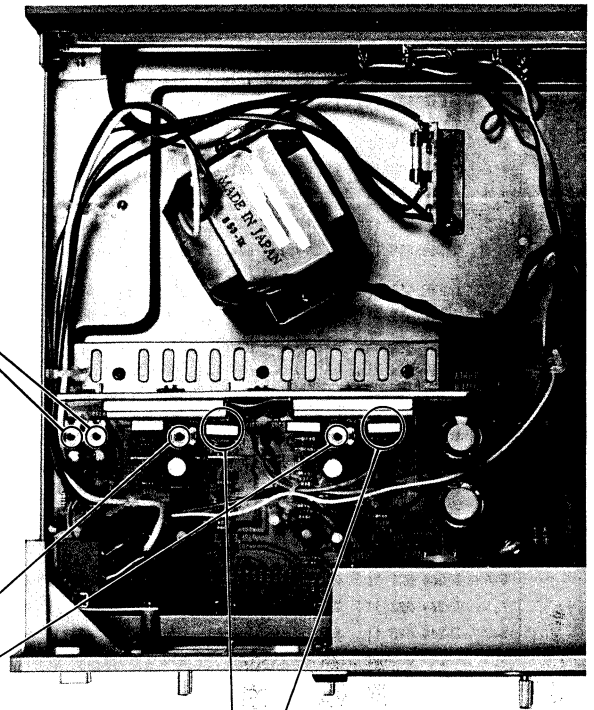

RV201 RV251

DC Bias Adjustment

1. Connect a VTVM.
2. With no input signal, adjust RV201 (L-CH) and RV251 (R-CH) for 10mV dc reading on VTVM.

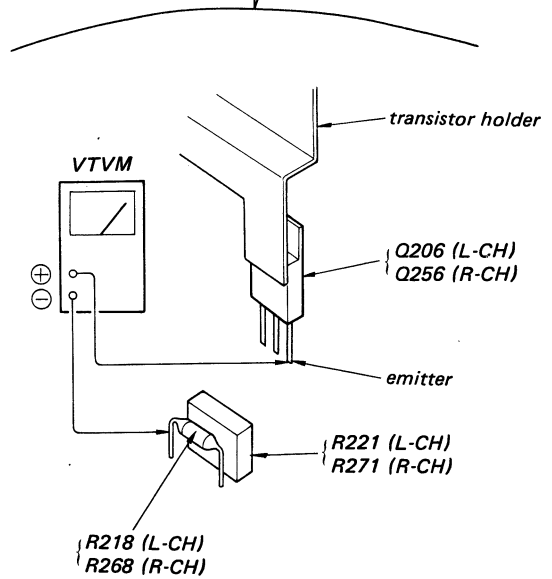

1/4 WATT CARBON RESISTORS (A)

Note: Circled letter (A) is applicable to European models only.

Ω	Part No.	Ω	Part No.	Ω	Part No.	Ω	Part No.	Ω	Part No.	Ω	Part No.	Ω	Part No.
1.0	1-244-601-11	10	1-244-625-11	100	1-244-649-11	1.0k	1-244-673-11	10k	1-244-697-11	100k	1-244-721-11	1.0M	1-244-745-11
1.1	1-244-602-11	11	1-244-626-11	110	1-244-650-11	1.1k	1-244-674-11	11k	1-244-698-11	110k	1-244-722-11	1.1M	1-244-746-11
1.2	1-244-603-11	12	1-244-627-11	120	1-244-651-11	1.2k	1-244-675-11	12k	1-244-699-11	120k	1-244-723-11	1.2M	1-244-747-11
1.3	1-244-604-11	13	1-244-628-11	130	1-244-652-11	1.3k	1-244-676-11	13k	1-244-700-11	130k	1-244-724-11	1.3M	1-244-748-11
1.5	1-244-605-11	15	1-244-629-11	150	1-244-653-11	1.5k	1-244-677-11	15k	1-244-701-11	150k	1-244-725-11	1.5M	1-244-749-11
1.6	1-244-606-11	16	1-244-630-11	160	1-244-654-11	1.6k	1-244-678-11	16k	1-244-702-11	160k	1-244-726-11	1.6M	1-244-750-11
1.8	1-244-607-11	18	1-244-631-11	180	1-244-655-11	1.8k	1-244-679-11	18k	1-244-703-11	180k	1-244-727-11	1.8M	1-244-751-11
2.0	1-244-608-11	20	1-244-632-11	200	1-244-656-11	2.0k	1-244-680-11	20k	1-244-704-11	200k	1-244-728-11	2.0M	1-244-752-11
2.2	1-244-609-11	22	1-244-633-11	220	1-244-657-11	2.2k	1-244-681-11	22k	1-244-705-11	220k	1-244-729-11	2.2M	1-244-753-11
2.4	1-244-610-11	24	1-244-634-11	240	1-244-658-11	2.4k	1-244-682-11	24k	1-244-706-11	240k	1-244-730-11	2.4M	1-244-754-11
2.7	1-244-611-11	27	1-244-635-11	270	1-244-659-11	2.7k	1-244-683-11	27k	1-244-707-11	270k	1-244-731-11	2.7M	1-244-755-11
3.0	1-244-612-11	30	1-244-636-11	300	1-244-660-11	3.0k	1-244-684-11	30k	1-244-708-11	300k	1-244-732-11	3.0M	1-244-756-11
3.3	1-244-613-11	33	1-244-637-11	330	1-244-661-11	3.3k	1-244-685-11	33k	1-244-709-11	330k	1-244-733-11	3.3M	1-244-757-11
3.6	1-244-614-11	36	1-244-638-11	360	1-244-662-11	3.6k	1-244-686-11	36k	1-244-710-11	360k	1-244-734-11	3.6M	1-244-758-11
3.9	1-244-615-11	39	1-244-639-11	390	1-244-663-11	3.9k	1-244-687-11	39k	1-244-711-11	390k	1-244-735-11	3.9M	1-244-759-11
4.3	1-244-616-11	43	1-244-640-11	430	1-244-664-11	4.3k	1-244-688-11	43k	1-244-712-11	430k	1-244-736-11	4.3M	1-244-760-11
4.7	1-244-617-11	47	1-244-641-11	470	1-244-665-11	4.7k	1-244-689-11	47k	1-244-713-11	470k	1-244-737-11	4.7M	1-244-761-11
5.1	1-244-618-11	51	1-244-642-11	510	1-244-666-11	5.1k	1-244-690-11	51k	1-244-714-11	510k	1-244-738-11	5.1M	1-244-762-11
5.6	1-244-619-11	56	1-244-643-11	560	1-244-667-11	5.6k	1-244-691-11	56k	1-244-715-11	560k	1-244-739-11		
6.2	1-244-620-11	62	1-244-644-11	620	1-244-668-11	6.2k	1-244-692-11	62k	1-244-716-11	620k	1-244-740-11		
6.8	1-244-621-11	68	1-244-645-11	680	1-244-669-11	6.8k	1-244-693-11	68k	1-244-717-11	680k	1-244-741-11		
7.5	1-244-622-11	75	1-244-646-11	750	1-244-670-11	7.5k	1-244-694-11	75k	1-244-718-11	750k	1-244-742-11		
8.2	1-244-623-11	82	1-244-647-11	820	1-244-671-11	8.2k	1-244-695-11	82k	1-244-719-11	820k	1-244-743-11		
9.1	1-244-624-11	91	1-244-648-11	910	1-244-672-11	9.1k	1-244-696-11	91k	1-244-720-11	910k	1-244-744-11		

HARDWARE NOMENCLATURE

Screw:

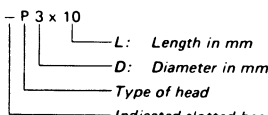

Unless otherwise indicated, it means cross-recessed head (Phillips type).

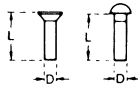

Nut, Washer, Retaining ring:

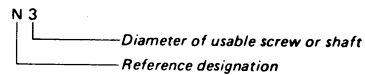

Reference Designation	Shape	Description	Remarks
SCREWS			
P		pan-head screw	binding-head (B) screw for replacement
PWH		pan-head screw with washer face	binding-head (B) screw and flat washer for replacement
PS PSP		pan-head screw with spring washer	binding-head (B) screw and spring washer for replacement
PSW PSPW		pan-head screw with spring and flat washers	binding-head (B) screw and spring and flat washers for replacement
R		round-head screw	binding-head (B) screw for replacement
K		flat-countersunk-head screw	
RK		oval-countersunk-head screw	
B		binding-head screw	
T		truss-head screw	binding-head (B) screw for replacement
F		flat-fillister-head screw	
RF		fillister-head screw	
BV		braizer-head screw	

Reference Designation	Shape	Description	Remarks
SELF-TAPPING SCREWS			
TA		self-tapping screw	ex: TA, P 3 x 10
PTP		pan-head self-tapping screw	binding-head self-tapping (TA, B) screw for replacement
PTPWH		pan-head self-tapping screw with washer face	binding-head self-tapping (TA, B) screw and flat washer for replacement
PTTWH		pan-head thread-rolling screw with washer face	binding-head (B) screw and flat washer for replacement
SET SCREWS			
SC		set screw	
SC		hexagon-socket set screw	ex: SC 2.6 x 4, hexagon socket
NUT			
N		nut	
WASHERS			
W		flat washer	
SW		spring washer	
LW		internal-tooth lock washer	ex: LW3, internal
LW		external-tooth lock washer	ex: LW3, external
RETAINING RINGS			
E		retaining ring	
G		grip-type retaining ring	

SECTION 4
DIAGRAMS

4-1. MOUNTING DIAGRAM — PREAMP and POWER AMP BOARDS —
— Conductor Side —

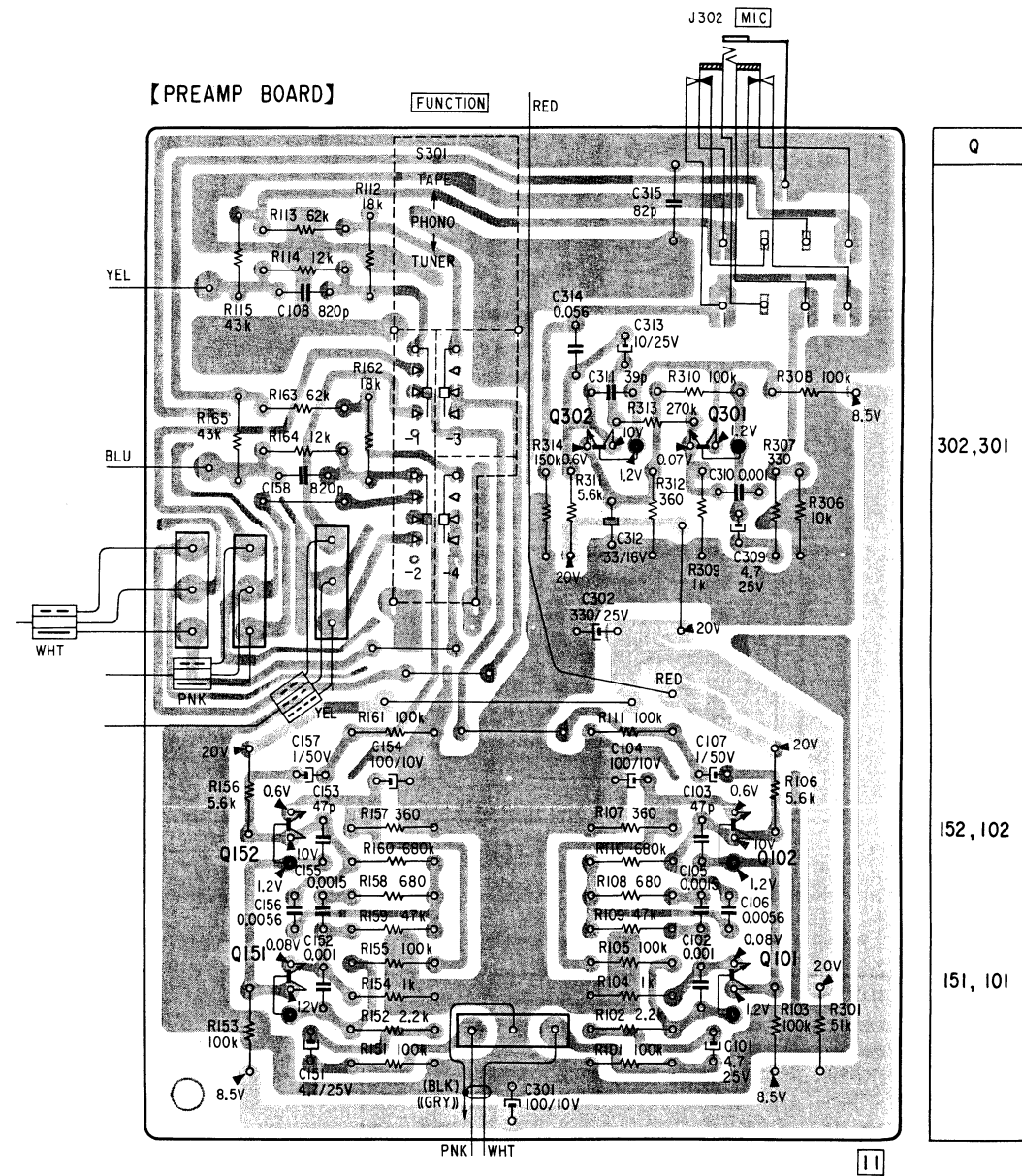

Q	207	205	202, 201, 203 206, 204	255 257	252, 251, 253 254 256
D	252 253	202 203	201	305	251

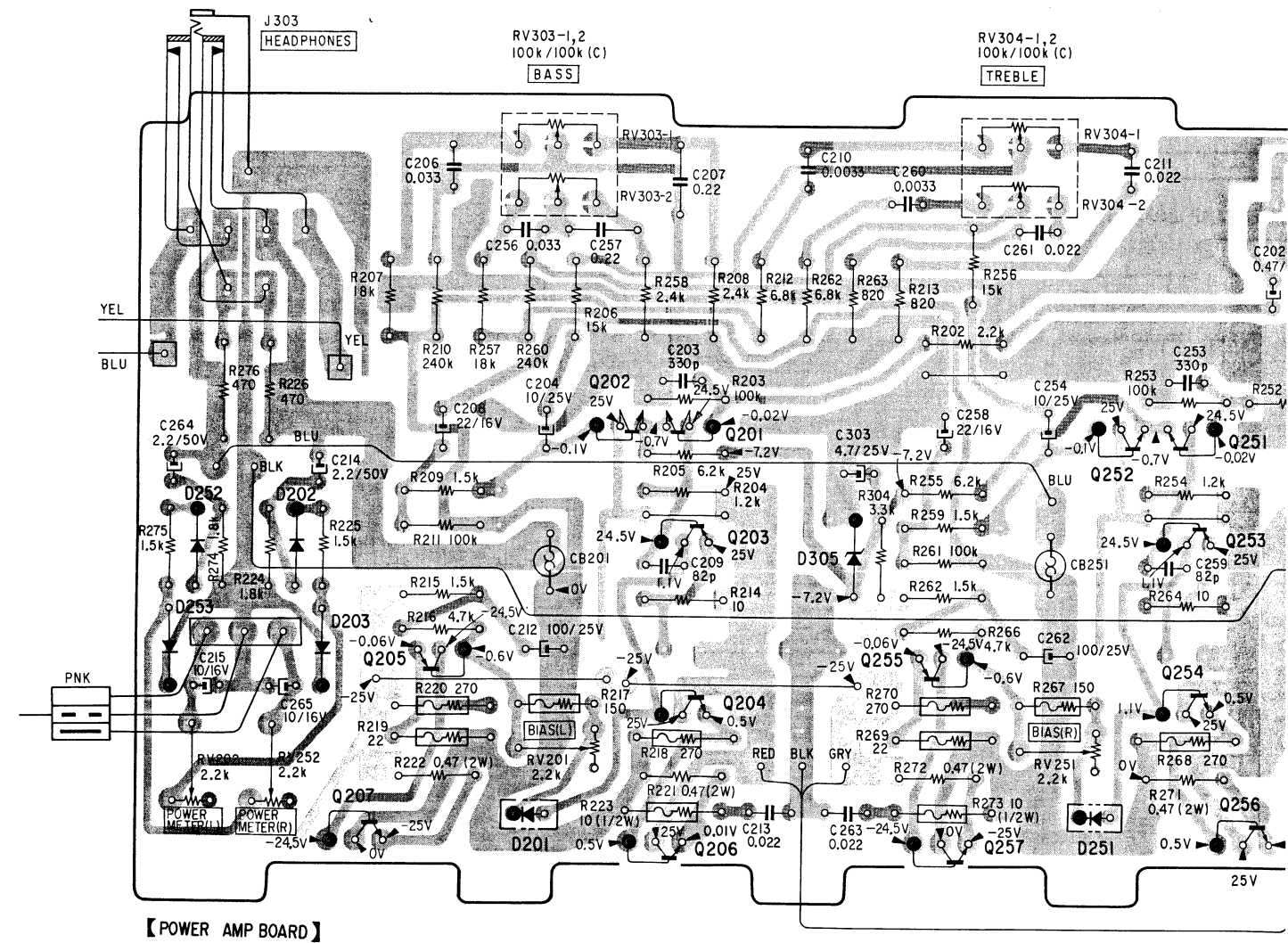

Note:

- Color code of sleeving over the end of the jacket.

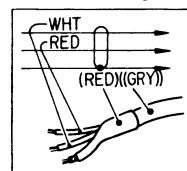

- B+ pattern.
- B- pattern.

Q	207	205	202, 201, 203 206, 204	255	252, 251, 253 254	256	303	Q
D	252 253	202 203	201	305	251	301 303	302 304	D

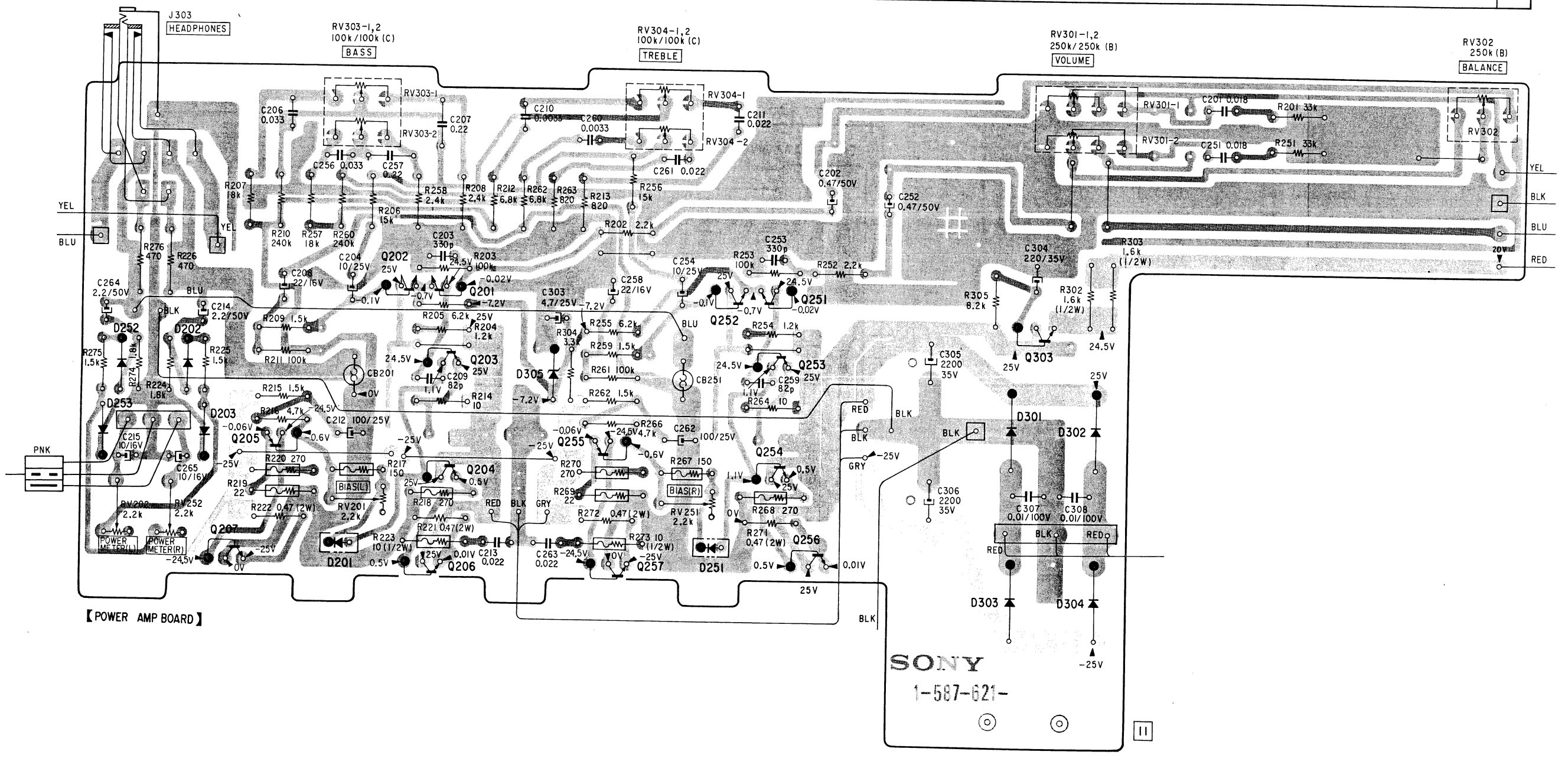

4-2. MOUNTING DIAGRAM

● Replacement Semiconductors

For replacement, use semiconductors except in ().

Q101, 151
Q102, 152
Q301, 302

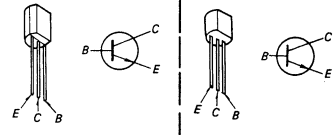

D201, 251: VD1221 (VD1222)

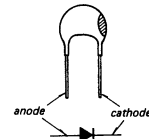

Q201, 251
Q202, 252
Q303

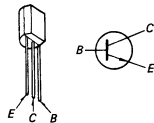

D202, 252
D203, 253
D305: RD6.8E-C (RD7.5EB2)

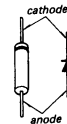

D301-304: 10E2 (1N4003)

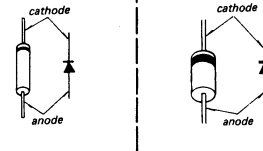

Q203, 253: 2SA684 (2SA953K)
Q205, 255: 2SA684 (2SA953L)

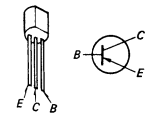

Q204, 254: 2SC1475 (2SC2002L)

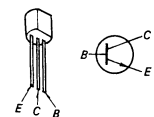

Q206, 256
Q207, 257

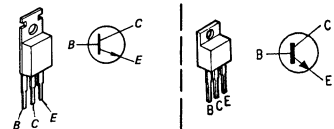

Note:

- Color code of sleeving over the end of the jacket.

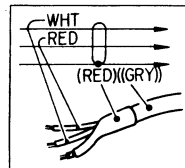

- B+ pattern.
- B- pattern.
- Signal Path
 - : MIC
 - - -: L-CH
 - - -: R-CH
- (F) : fusible resistor.

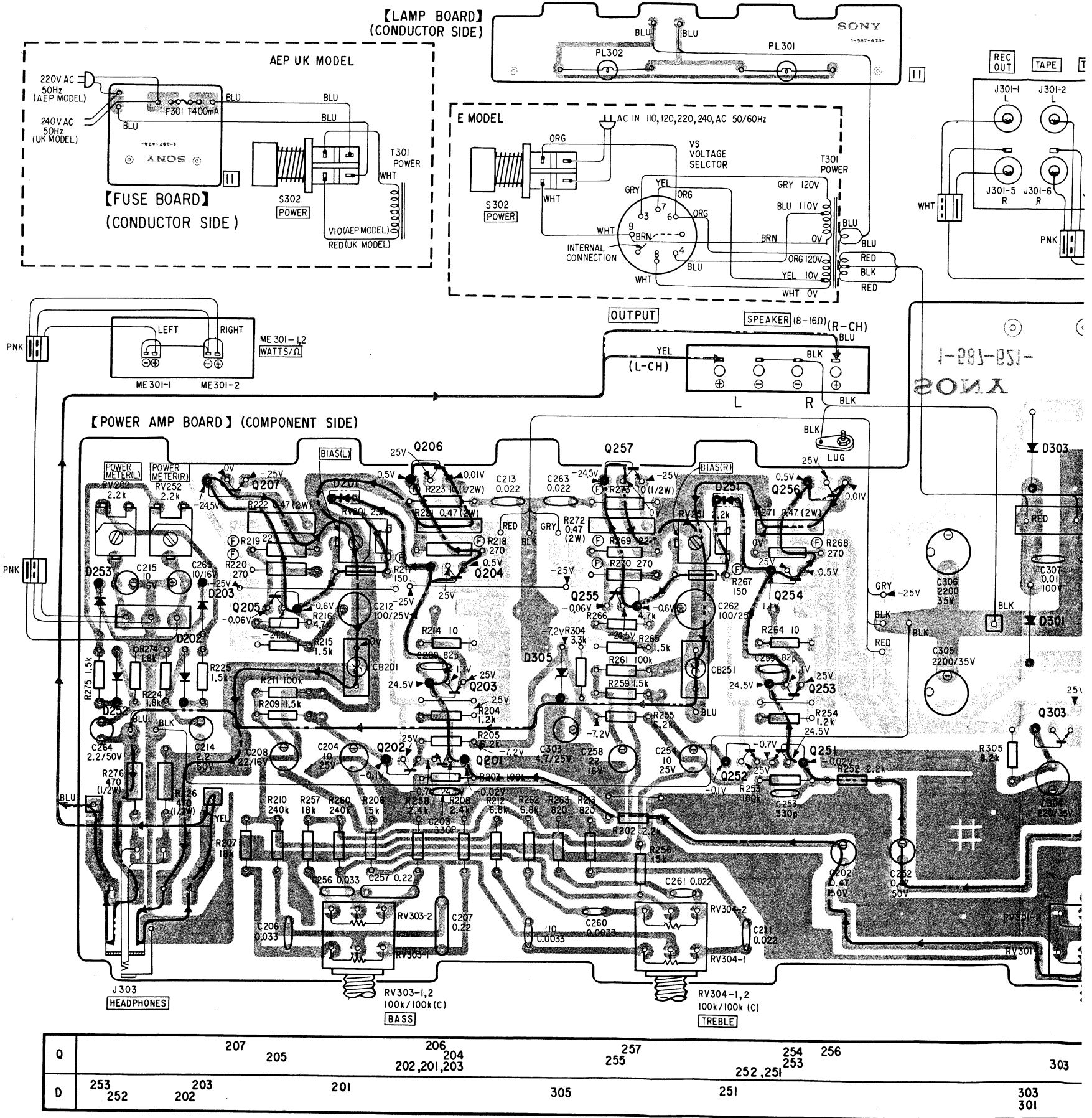

Q		207	205		206	204		257		254	256	
D	253	203	201		202, 201, 203		305		251	252, 251	253	303
	252	202										301

【LAMP BOARD】
(CONDUCTOR SIDE)

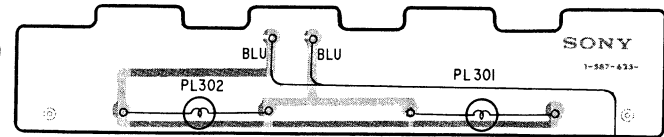

E MODEL

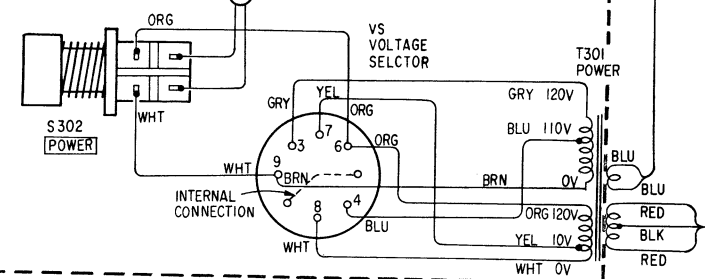

AEP UK MODEL

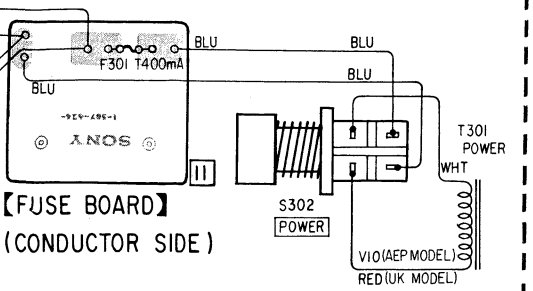

【FUSE BOARD】
(CONDUCTOR SIDE)

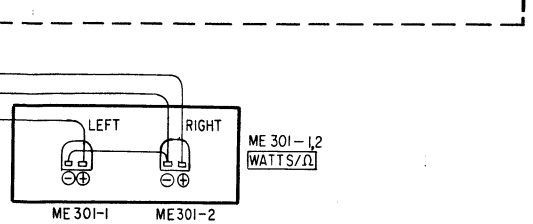

POWER AMP BOARD】 (COMPONENT SIDE)

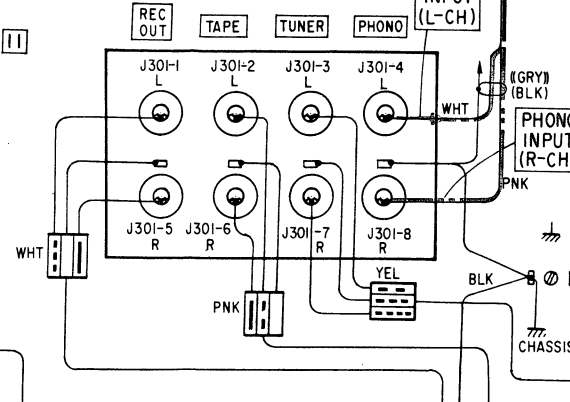
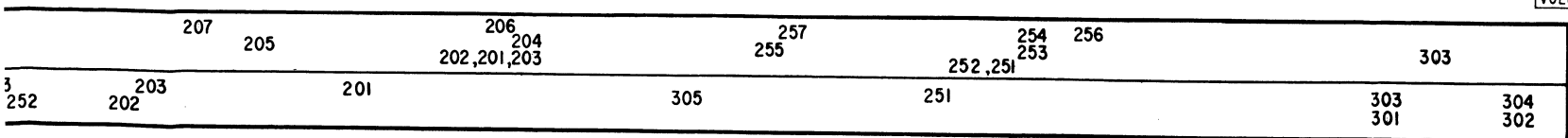
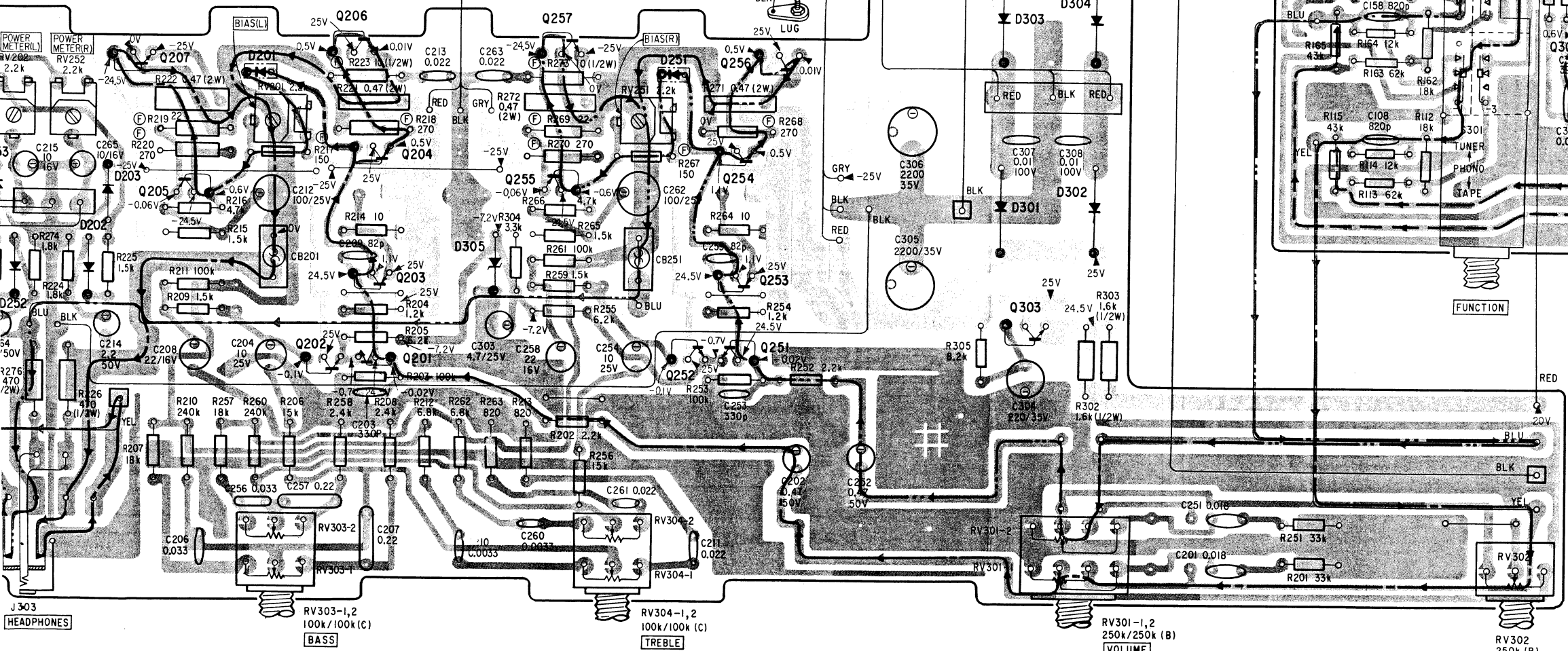

【PREAMP BOARD】 (COMPONENT SIDE)

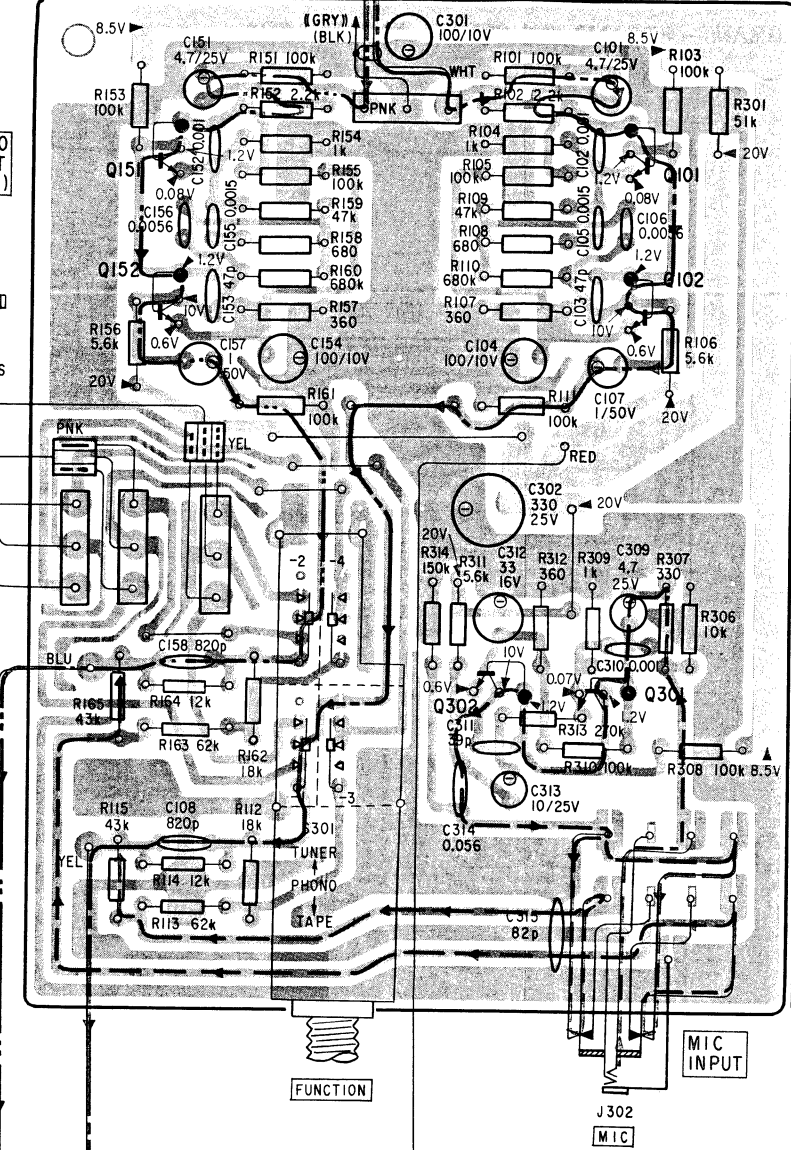

4-3. SCHEMATIC DIAGRAM

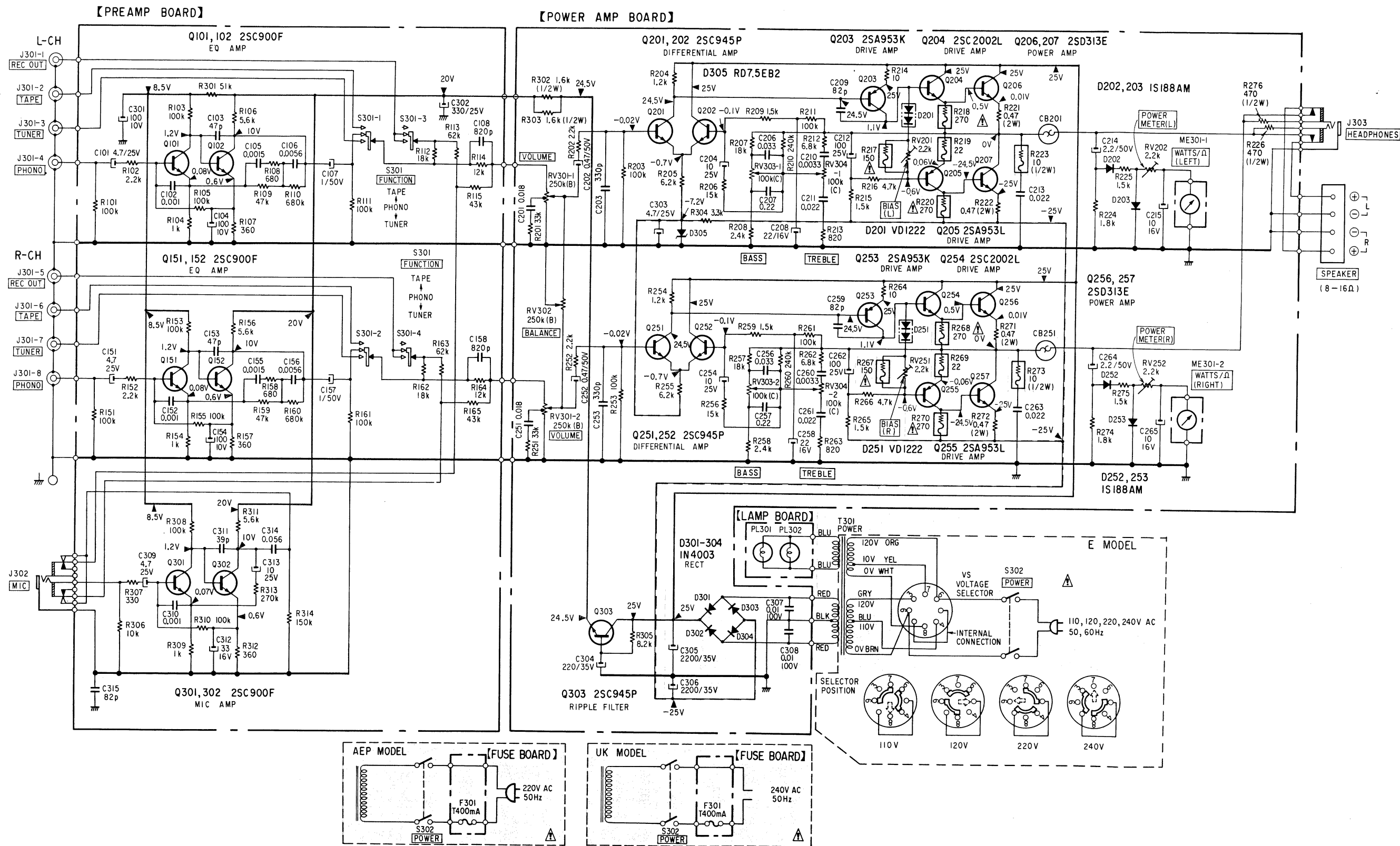

Note:

- All capacitors are in μF unless otherwise noted. $\text{pF} : \mu\text{F}$ 50WV or less are not indicated except for electrolytics.
- All resistors are in ohms, $\frac{1}{4}\text{W}$ unless otherwise noted. $\text{k}\Omega : 1000\Omega$, $\text{M}\Omega : 1000\text{k}\Omega$
- : fusible resistor.

- : B+ bus.
- : B- bus.
- : panel designation.
- : adjustment for repair.

- Voltages are dc with respect to ground unless otherwise noted.
- Readings are taken under no signal conditions with a VOM (20k Ω /V).
- Voltage variations may be noted due to normal production tolerances.

• Switch

Ref. No.	Switch	Position
S301-1 to 301-4	FUNCTION	PHONO
S302	POWER	OFF

Note: The components identified by shading and mark are critical for safety. Replace only with part number specified.

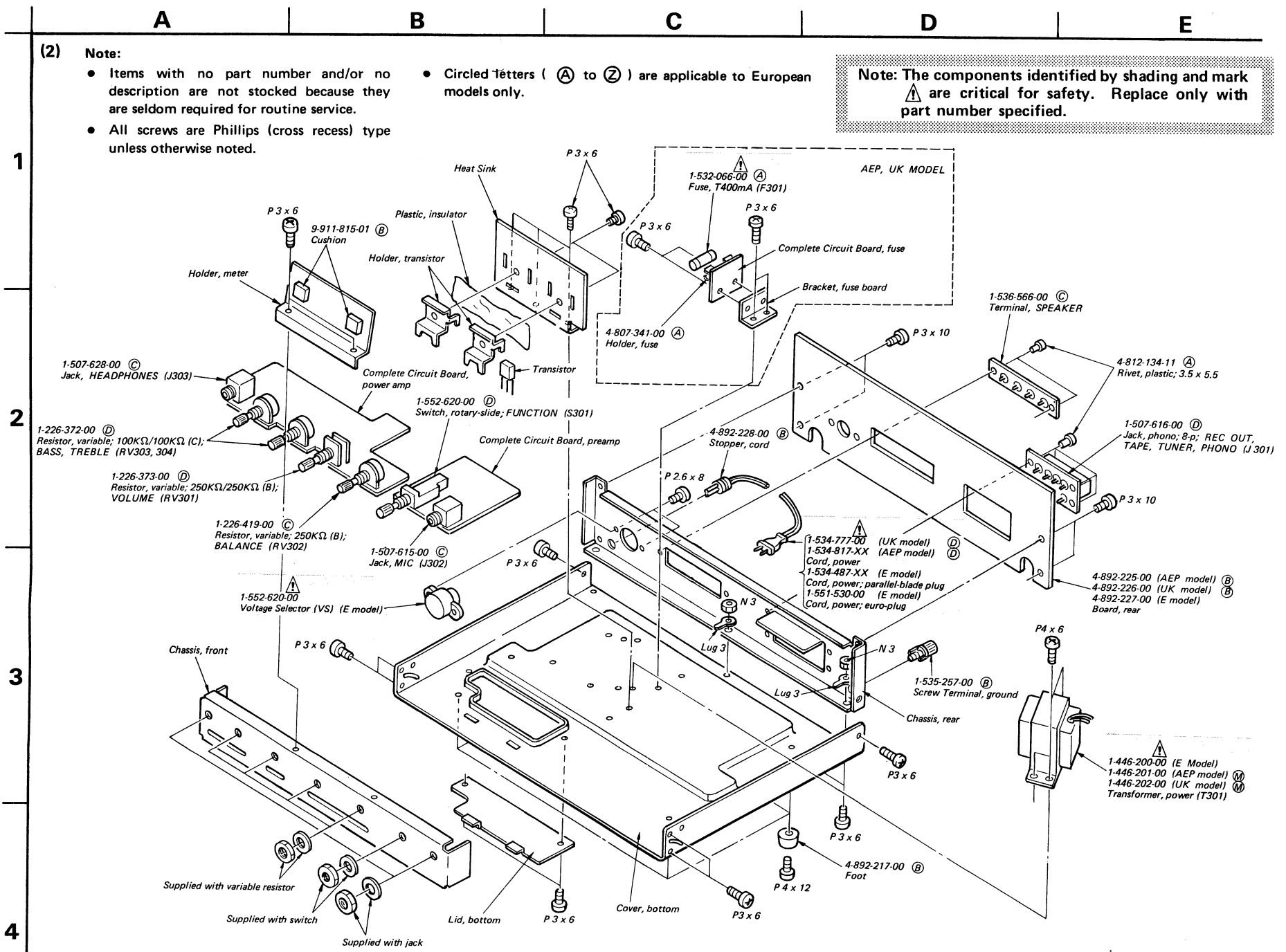
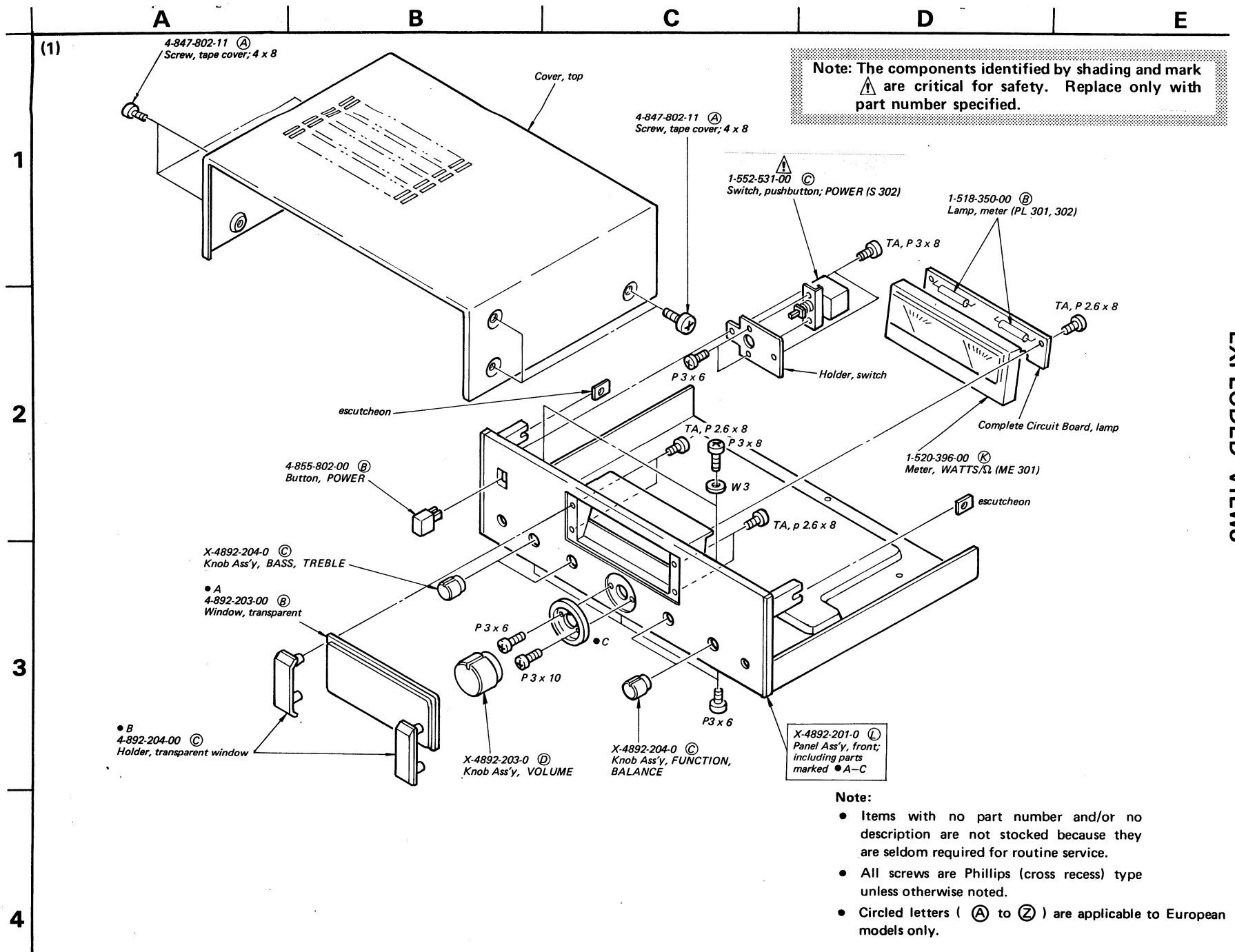

SECTION 6 ELECTRICAL PARTS LIST

● Circled letters (**A** to **Z**) are applicable to European models only.

Ref. No.	Part No.	Description		
SEMICONDUCTORS				
Transistors				
⇒ Q101, 151 ⇒ Q102, 152 ⇒ Q201, 251 ⇒ Q202, 252	8-729-665-47	B 2SC1362		
⇒ Q203, 253			8-729-468-43	C 2SA684
⇒ Q204, 254			8-760-413-10	C 2SC1475
⇒ Q205, 255			8-729-468-43	C 2SA684
⇒ Q206, 265 ⇒ Q207, 257	8-729-316-12	D 2SC1061		
⇒ Q301-303			8-729-665-47	B 2SC1362
Diodes				
⇒ D201, 251	8-719-122-10	B VD1221		
⇒ D202, 252 ⇒ D203, 253	8-719-422-21	B 1T22AM		
⇒ D301-304			8-719-200-02	B 10E2
⇒ D305	8-719-168-77	A RD6.8E-C		
TRANSFORMERS				
T301	A 1-446-200-00	Power (E model)		
T301	A 1-446-201-00	M Power (AEP model)		
T301	A 1-446-202-00	M Power (UK model)		
CAPACITORS				
All capacitors are in μ F and ceramic unless otherwise noted. 50WV or less are not indicated except for electrolytics. p : μ F, elect : electrolytic				
C101, 151	1-121-395-00	A 4.7 25V elect		
C102, 152	1-102-074-00	A 0.001		
C103, 153	1-101-888-00	A 47p		
C104, 154	1-121-414-00	A 100 10V elect		
C105, 155	1-108-367-00	A 0.0015 mylar		
C106, 156	1-108-623-00	A 0.0056 mylar		
C107, 157	1-121-391-00	A 1 50V elect		
C108, 158	1-102-117-00	A 820p		
C201, 251	1-108-380-00	A 0.018 mylar		

● ⇒: Due to standardization, interchangeable replacements may be substituted for parts specified in the diagrams.

Ref. No.	Part No.	Description
C202, 252	1-121-726-00	A 0.47 50V elect
C203, 253	1-102-112-00	A 330p
C204, 254	1-123-187-00	A 10 25V elect
C206, 256	1-108-383-00	A 0.033 mylar
C207, 257	1-108-611-00	B 0.22 mylar
C208, 258	1-121-479-00	A 22 16V elect
C209, 259	1-102-971-00	A 82p
C210, 260	1-108-620-00	A 0.0033 mylar
C211, 261	1-108-381-00	B 0.022 mylar
C212, 262	1-121-417-00	B 100 25V elect
C213, 263	1-108-381-00	B 0.022 mylar
C214, 264	1-121-450-00	A 2.2 50V elect
C215, 265	1-121-651-00	A 10 16V elect
C301	1-121-414-00	A 100 10V elect
C302	1-121-654-00	B 330 25V elect
C303	1-121-395-00	A 4.7 25V elect
C304	1-121-261-00	B 220 35V elect
C305, 306	A 1-121-984-00	D 2200 35V elect
C307, 308	A 1-108-377-00	A 0.01 100V mylar
C309	1-121-395-00	A 4.7 25V elect
C310	1-102-074-00	A 0.001
C311	1-101-965-00	A 39p
C312	1-121-403-00	A 33 16V elect
C313	1-123-187-00	A 10 25V elect
C314	1-108-417-00	A 0.056 mylar
C315	1-102-971-00	A 82p

RESISTORS

All resistors are in ohms. Common $\frac{1}{4}$ W carbon resistors are omitted. Refer to the list page 6 for their part numbers.

R217, 267	A 1-212-885-00	A 150 $\frac{1}{4}$ W fusible
R218, 268	A 1-212-891-00	B 270 $\frac{1}{4}$ W fusible
R219, 269	A 1-212-865-00	A 22 $\frac{1}{4}$ W fusible
R220, 270	A 1-212-891-00	B 270 $\frac{1}{4}$ W fusible
R221, 271	A 1-217-153-00	A 0.47 2W metal plate
R222, 272		
R223, 273	A 1-212-958-00	A 10 $\frac{1}{2}$ W fusible
R226, 276	1-242-465-00	A 470 $\frac{1}{2}$ W carbon
R302, 303	1-246-478-00	A 1.6k $\frac{1}{2}$ W carbon

Note: The components identified by shading and mark **A** are critical for safety. Replace only with part number specified.

- Circled letters (A to Z) are applicable to European models only.

<u>Ref. No.</u>	<u>Part No.</u>	<u>Description</u>
RV201,251 RV202,252	1-226-234-00	(A) 2.2k (B), adjustable
RV301	1-226-373-00	(D) 250k/250k (B), variable; VOLUME
RV302	1-226-419-00	(C) 250k (B), variable; BALANCE
RV303,304	1-226-372-00	(D) 100k/100k (C), variable; BASS, TREBLE

SWITCHES

S301	1-552-620-00	(D) Rotary-slide, FUNCTION
S302	(A) 1-552-531-00	(C) Pushbutton, POWER

JACKS

J301	1-507-616-00	(D) Phono, 8-p; REC OUT, TAPE, TUNER, PHONO
J302	1-507-615-00	(C) MIC
J303	1-507-628-00	(C) HEADPHONES
VS	(A) 1-552-620-00	Voltage Selector (E model)

MISCELLANEOUS

CB201,251	(A) 1-532-549-00	(C) Circuit Breaker
F301	(A) 1-532-066-00	(A) Fuse, T400mA (AEP, UK model)
ME301	1-520-396-00	(K) Meter, WATTS/ Ω
PL301,302	1-518-350-00	(B) Lamp, meter
(A) 1-534-487-XX		Cord, power; parallel-blade plug (E model)
(A) 1-534-777-00		(D) Cord, power (UK model)
(A) 1-534-817-XX		(D) Cord, power (AEP model)
1-535-257-00		(B) Screw Terminal, ground
1-536-566-00		(C) Terminal, SPEAKER
(A) 1-551-530-00		Cord, power; euro-plug (E model)

Note: The components identified by shading and mark (A) are critical for safety. Replace only with part number specified.

ACCESSORIES & PACKING MATERIALS

<u>Part No.</u>	<u>Description</u>
3-701-630-00	(A) Bag, plastic; instruction manual
4-891-037-00	(B) Bag, plastic; set
4-892-219-00	(C) Cushion
4-892-220-00	(D) Carton
4-892-229-00	(B) Sheet, protection
4-892-290-00	(B) Manual, instruction (AEP, UK model)
4-892-299-11	(C) Manual, instruction (E model)
4-892-299-11	Manual, instruction (E model)

Sony Corporation

9-958-546-01

© 1978

78I0479-1
Printed in Japan