

Request For Quotation

Order the parts you need from our real-time inventory database. Simply complete a request for quotation form with your part information and a sales representative will respond to you with price and availability.

[Request For Quotation](#)

Your free datasheet starts on the next page.

More datasheets and data books are available from our homepage: <http://www.datasheetarchive.com>

**LB1650****Dual Bidirectional Motor Driver****Overview**

The LB1650 is a dual bidirectional motor driver that is designed to accept standard TTL input logic levels and drive motors. It provides the functions of bidirectional motor drive, brake that are determined by two inputs and the inhibit function that brings the output to a high impedance state.

Applications

- Multi DC motor driver.
- Bidirectional motor driver.
- Bipolar stepping motor driver.

Features

- High output current (1A/ch).
- Wide operating voltage range (4.5 to 36V).
- Inhibit facility.
- Input connectable to TTL, CMOS IC.
- High noise margin.

Package Dimensions

unit:mm

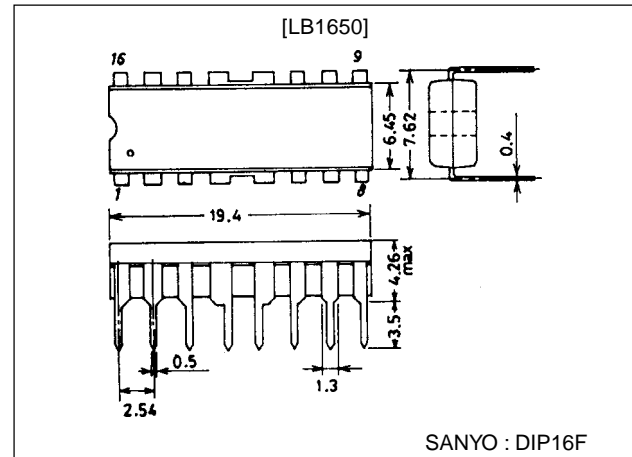
3054A-DIP16F**Specifications****Absolute Maximum Ratings at Ta = 25°C**

Parameter	Symbol	Conditions	Ratings	Unit
Maximum supply voltage	V _{CC} 1		36	V
Logic supply voltage	V _{CC} 2		36	V
Input voltage	V _{IN}		7	V
Inhibit voltage	V _{inh}		7	V
Peak output current	I _{OUT}	1ms non-repetitive	2	A
Allowable power dissipation	Pd max	IC only	1.9	W
Operating temperature	Topr		-20 to +80	°C
Storage temperature	Tstg		-40 to +150	°C

Allowable Operating Conditions at Ta = 25°C

Parameter	Symbol	Conditions	Ratings	Unit
Supply voltage	V _{CC} 1		4.5 to 36	V
Logic supply voltage	V _{CC} 2		4.5 to 36	V

■ Any and all SANYO products described or contained herein do not have specifications that can handle applications that require extremely high levels of reliability, such as life-support systems, aircraft's control systems, or other applications whose failure can be reasonably expected to result in serious physical and/or material damage. Consult with your SANYO representative nearest you before using any SANYO products described or contained herein in such applications.

■ SANYO assumes no responsibility for equipment failures that result from using products at values that exceed, even momentarily, rated values (such as maximum ratings, operating condition ranges, or other parameters) listed in products specifications of any and all SANYO products described or contained herein.

SANYO Electric Co., Ltd. Semiconductor Business Headquarters

TOKYO OFFICE Tokyo Bldg., 1-10, 1 Chome, Ueno, Taito-ku, TOKYO, 110-8534 JAPAN

LB1650

Electrical Characteristics at $T_a = 25^\circ\text{C}$, $V_{CC1}=24\text{V}$, $V_{CC2}=5\text{V}$

Parameter	Symbol	Conditions	Ratings			Unit
			min	typ	max	
Supply current (per CH)	I_{CC1}	$V_{IN}=L, I_O=0, V_{inh}=H$			1.5	mA
		$V_{IN}=H, I_O=0, V_{inh}=H$			6	mA
		$V_{inh}=L$			1	mA
Logic supply current	I_{CC2}	$V_{IN}=L, I_O=0, V_{inh}=H$		44	60	mA
		$V_{IN}=H, I_O=0, V_{inh}=H$			22	mA
		$V_{inh}=L$			24	mA
Low-level input voltage	V_{IL}		-0.3		1.5	V
High-level input voltage	V_{IH}	$V_{CC2} \leq 7\text{V}$	2.3		V_{CC2}	V
		$V_{CC2} \leq 7\text{V}$	2.3		7	V
Low-level input current	I_{IL}	$V_{IN}=L$			± 10	μA
High-level input current	I_{IH}	$V_{IN}=H-0.3\text{V}$		30	100	μA
Low-level inhibit voltage	V_{inhL}		-0.3		1.5	V
High-level inhibit voltage	V_{inhH}	$V_{CC2} \leq 7\text{V}$	2.3		V_{CC2}	V
		$V_{CC2} \leq 7\text{V}$	2.3		7	V
Low-level inhibit current	I_{inhL}		-100	-30		μA
High-level inhibit current	I_{inhH}				± 10	μA
Saturation voltage	$V_{CE(sat)H}$	$I_O=-1\text{A}$		1.4	1.8	V
	$V_{CE(sat)L}$	$I_O=1\text{A}$		1.2	1.8	V

Truth Table

V_{IN} (per CH)	V_{inh}	V_O
H	H	H
L	H	L
H	L	Open*
L	L	Open*

* : High impedance

Pin Assignment

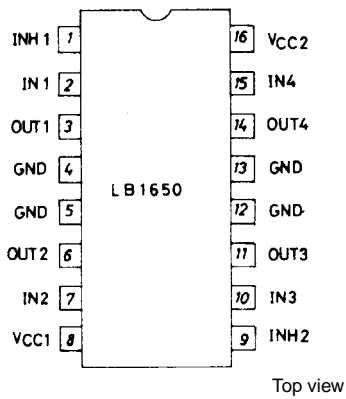

Equivalent Circuit Block Diagram and Peripheral Circuit

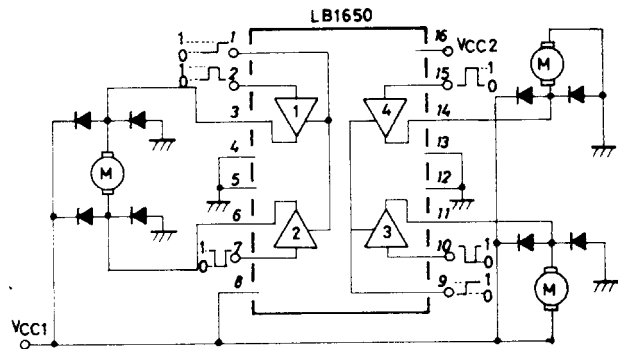

Sample Application Circuits

(1) DC motor control

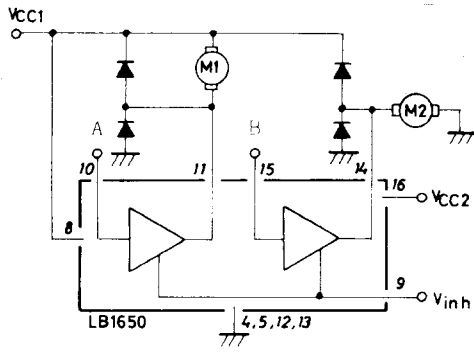

V _{inh}	A	M1	B	M2
H	H	Brake	H	Forward
H	L	Forward	L	Brake
L	X	Open*	X	Open*

X : don't care

(2) DC motor control (Forward, reverse)

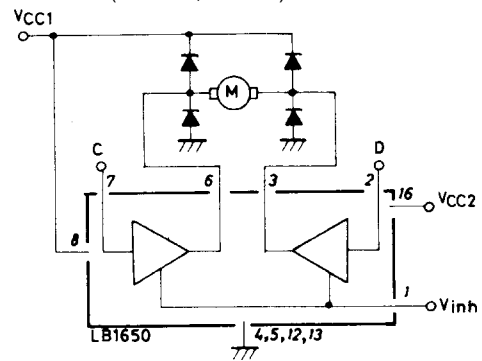

Input		Function
V _{inh}	C=H D=L	Forward (right)
	C=L D=H	Reverse (left)
	C=D	Brake
V _{inh} =L	C=X D=X	Open*

* : High impedance

(3) Stepping motor control (Bipolar drive)

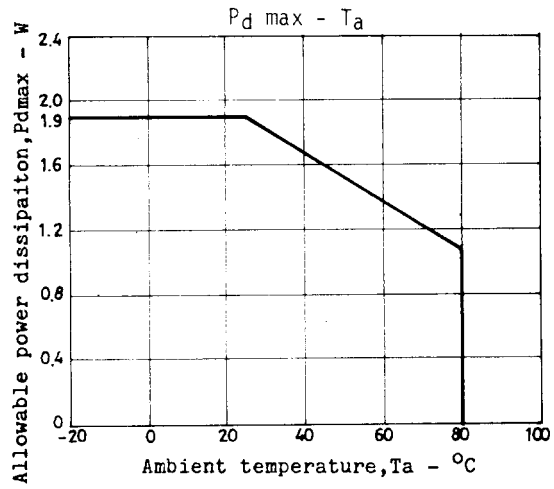
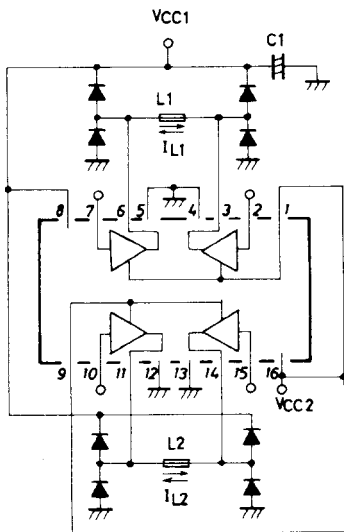

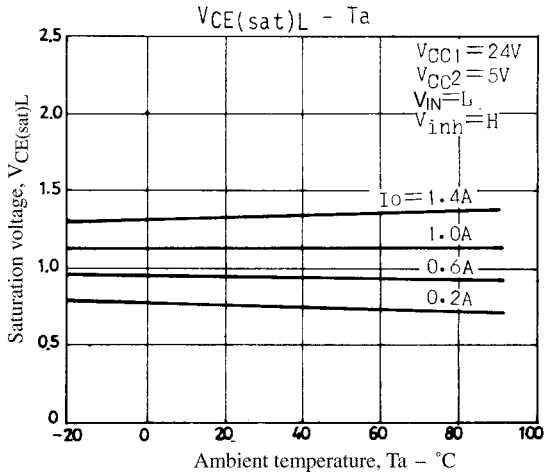
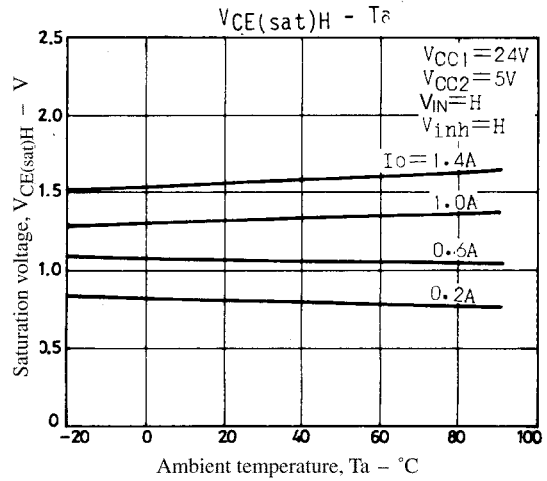
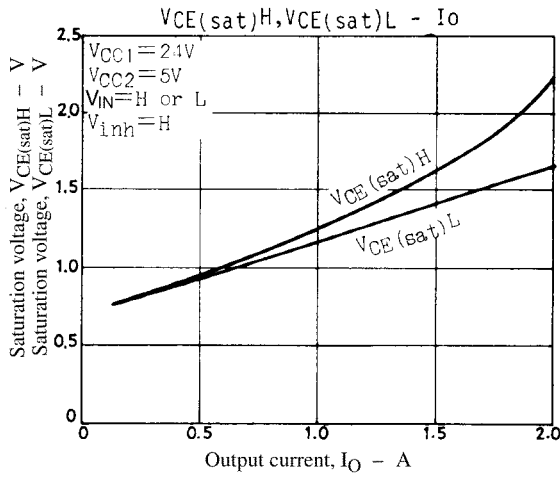
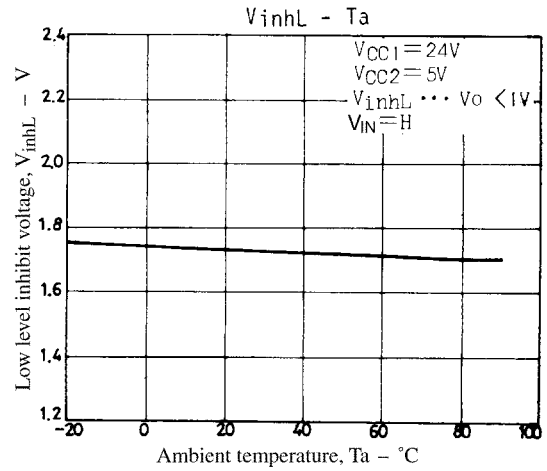
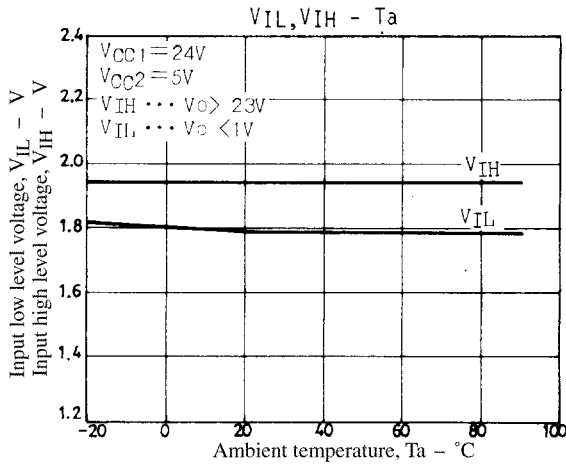
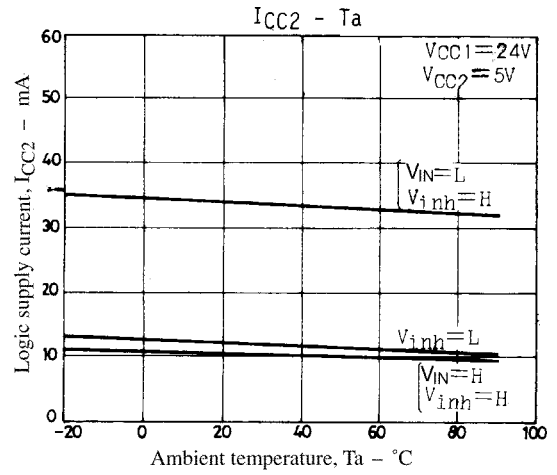
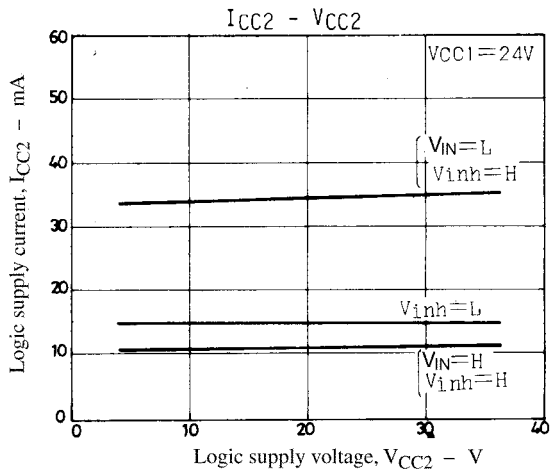

- Specifications of any and all SANYO products described or contained herein stipulate the performance, characteristics, and functions of the described products in the independent state, and are not guarantees of the performance, characteristics, and functions of the described products as mounted in the customer's products or equipment. To verify symptoms and states that cannot be evaluated in an independent device, the customer should always evaluate and test devices mounted in the customer's products or equipment.
- SANYO Electric Co., Ltd. strives to supply high-quality high-reliability products. However, any and all semiconductor products fail with some probability. It is possible that these probabilistic failures could give rise to accidents or events that could endanger human lives, that could give rise to smoke or fire, or that could cause damage to other property. When designing equipment, adopt safety measures so that these kinds of accidents or events cannot occur. Such measures include but are not limited to protective circuits and error prevention circuits for safe design, redundant design, and structural design.
- In the event that any and all SANYO products described or contained herein fall under strategic products (including services) controlled under the Foreign Exchange and Foreign Trade Control Law of Japan, such products must not be exported without obtaining export license from the Ministry of International Trade and Industry in accordance with the above law.
- No part of this publication may be reproduced or transmitted in any form or by any means, electronic or mechanical, including photocopying and recording, or any information storage or retrieval system, or otherwise, without the prior written permission of SANYO Electric Co., Ltd.
- Any and all information described or contained herein are subject to change without notice due to product/technology improvement, etc. When designing equipment, refer to the "Delivery Specification" for the SANYO product that you intend to use.
- Information (including circuit diagrams and circuit parameters) herein is for example only ; it is not guaranteed for volume production. SANYO believes information herein is accurate and reliable, but no guarantees are made or implied regarding its use or any infringements of intellectual property rights or other rights of third parties.

This catalog provides information as of August, 1998. Specifications and information herein are subject to change without notice.