

# Service Manual

E l e c t r o n i c s

## 8200CDQ V12E

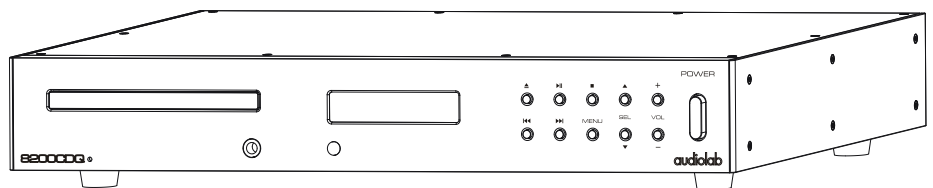

**VERSION HISTORY**

Rev	Date	Update Content
V01	Nov. 15, 2011	First Release

1. Introduction .....	1
2. Specification .....	2
3. Assembly Sketch .....	3
4. Schematic Diagram .....	4-5
5. Wiring Diagram .....	6
6. Silkscreen of Top/Bottom .....	7-14
7. Maintenance Alignment Procedure .....	15
8. Assembly Parts List .....	16-17
9. Electronic Parts List .....	18-28
10. Country Bom Deviation .....	29

No part of this document may be reproduced or transmitted in any form or by any means, electronic or mechanical, for any purpose, without the express written permission of International Audio Group Limited (IAG)

This manual is for the exclusive use of IAG, its approved distributors and approved UK service agents.

No part of this manual shall be transferred to any other party without the express written permission of IAG.

It is the responsibility of the user to ensure that all the information contained in this manual is current. Notification for new issues of this manual and minor updates will be given via the IAG web-site or on request.

This manual has been prepared with the greatest care, it is intended for information only and no liability shall be accepted for errors or changes to specification.

For further service information, parts lists and updates, please contact our web-site at [www.international audio group.com](http://www.internationalaudio.com) .

© 2011 International Audio Group Limited. All rights reserved.

## 8200CDQ V12E-Specification And Features -P1/1

<b>Output Level @ 1KHz (Standard Setting)</b>	<b>RCA:2.05Vrms±0.1</b>
	<b>XLR:4.1Vrms±0.1</b>
<b>Frequency Respones,Ref.1KHz,20Hz to 20KHz</b>	<b>RCA:±0.2dB</b>
	<b>XLR:±0.2dB</b>
<b>THD 1KHz,0dB,20Hz to 20KHz BW</b>	<b>RCA:&lt; 0.0025%</b>
	<b>XLR:&lt; 0.0008%</b>
<b>Crosstalk 1KHz</b>	<b>RCA:&gt; 120dB</b>
	<b>XLR:&gt; 130dB</b>
<b>Dynamic Range Awtd</b>	<b>RCA:&gt; 98dB</b>
	<b>XLR:&gt; 110dB</b>

### Product Features

- 32Bit 84.672MHz Oversampled/Upsampled 512 Element MultiBit Array DAC
- x1920 times Oversampled with CD/USB 44.1KHz Source
- Asynchronous USB supporting 24 Bit /96KHz with Driverless Remote Control of PC/MAC Media Player(Via HID Support)
- x2 96KHz 24Bits Coax SPDIF Digital Inputs
- x2 96KHz Optical Digital Inputs
- x3 Analogue Line level inputs (CDQ)
- Low Jitter Optical and Coax SPDIF Output (CD Digital Output only)
- Selectable Analogue or Digital Pre-Amplifier Mode (CDQ)
- High Current Single Ended & Balanced Discrete Class A Output stages
- High Performance Direct coupled Discrete Class A Headphone Amplifier (CDQ)
- Custom CD Servo Design-with Ultra Low Noise PSU for OPU
- Full Remote control & External Remote I/O loop
- 34 Regulated supply rails
- 14 Ultra Low Noise Discrete Regulators
- User Selectable Digital Filters-Software upgradeable Via USB Port
- Master Clock Jitter less then 3pS Short Term.Measured directly at DAC "XOut"
- Organic Ultra Low ESR cappacitors,High Tolerance Polypropylene film/Foil capacitors,Ultra Stable Very Low VCR 0.1% MELF SMD resistors,4 Layer PCB.

ASSEMBLY SKETCH

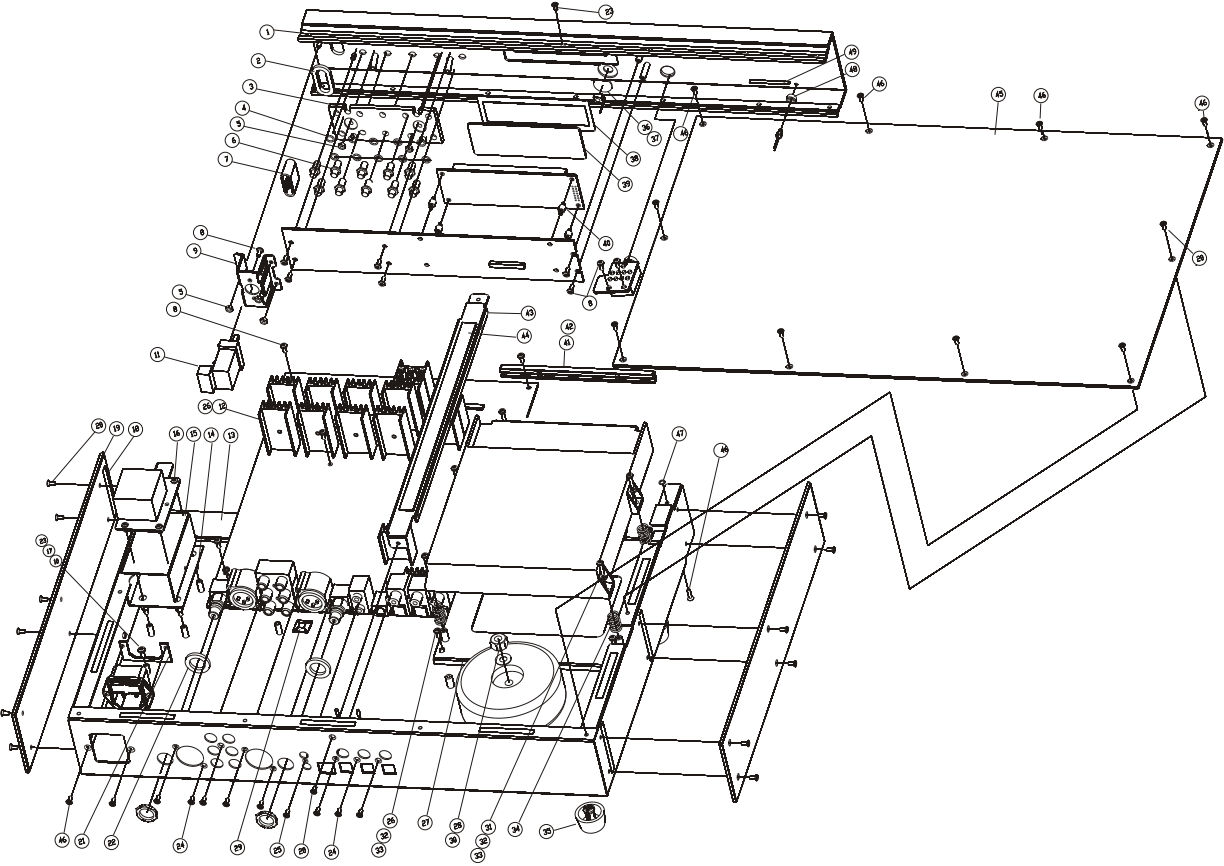

# SCHEMATIC DIAGRAM

8200CDQ V12E-Mainboard-P1/1

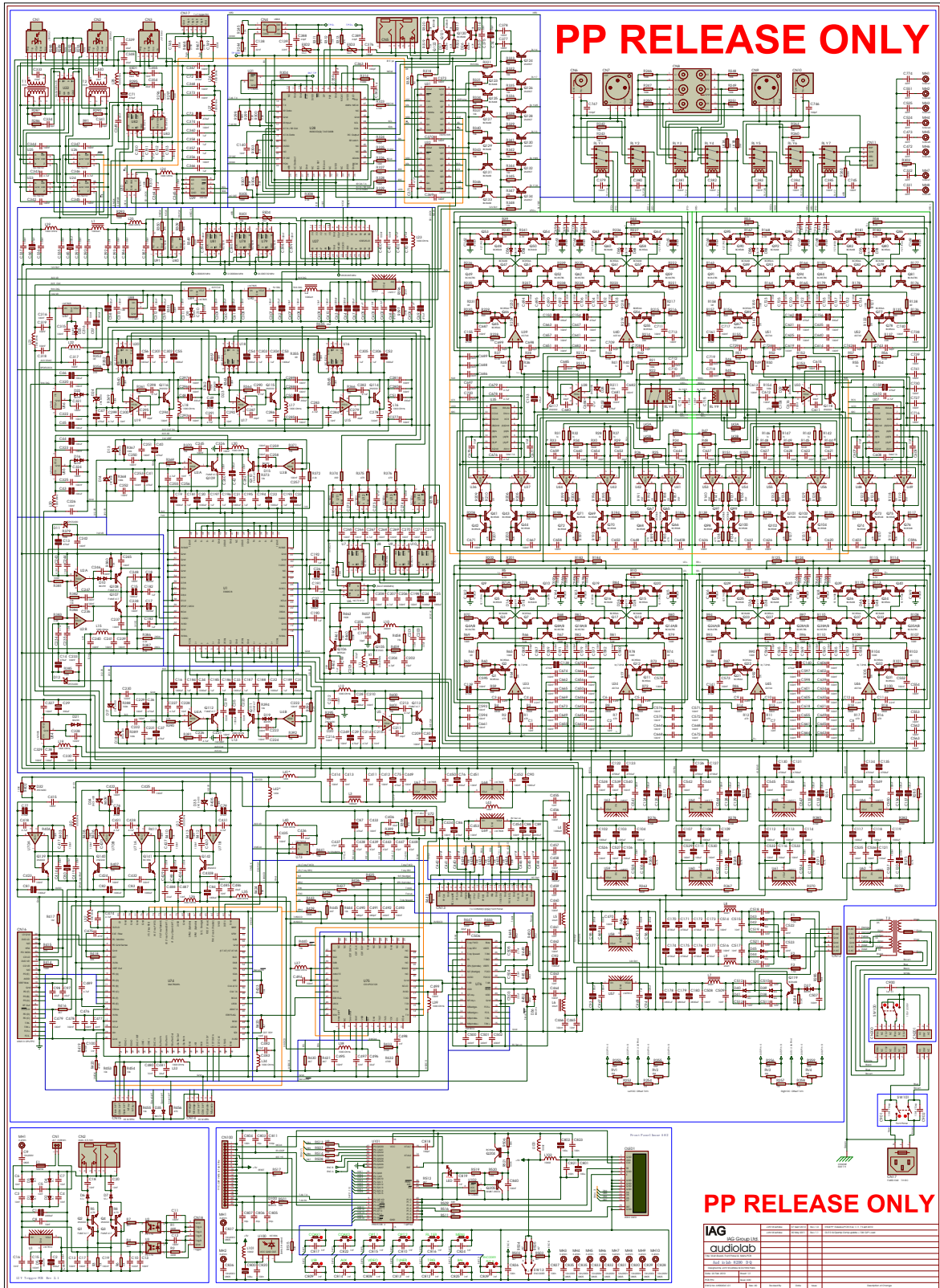

# SCHEMATIC DIAGRAM

## 8200CDQ V12E-Front Board-P1/1

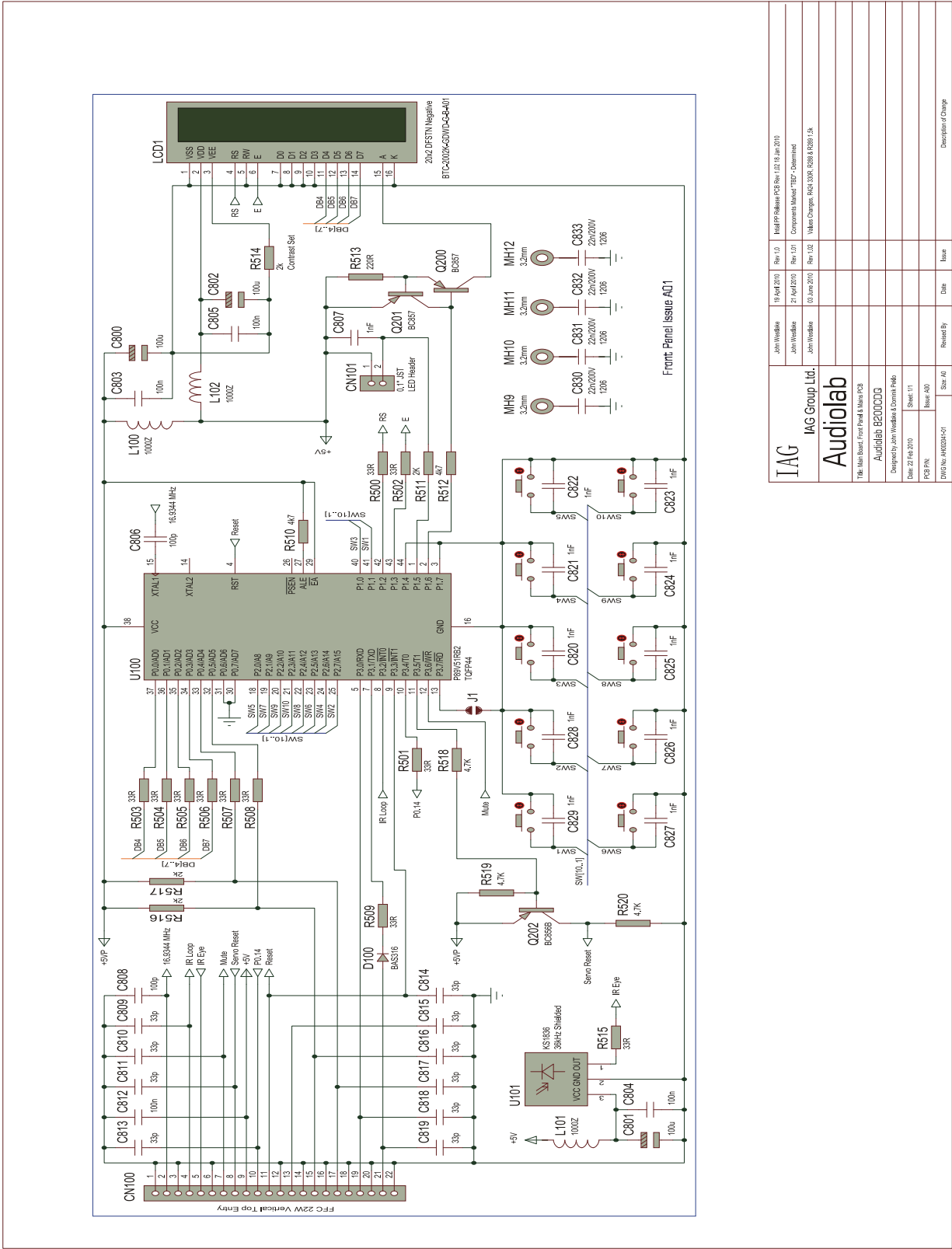

<b>IAG</b> IAG Group Ltd. <b>Audiolab</b>	19 April 2010	Rev 1.0	Initial Release PCB Rev 1.02 18 Jan 2010
	21 April 2010	Rev 1.01	Component Market "TSP" Discontinued
	10 June 2010	Rev 1.02	Values Changes: R512 33R, R520 & R514 15A
This Main Board: Front Panel & Main PCB <b>Audiolab 8200CDQ</b> Designed by John Woodhead & Graham Pinks Date: 27 Feb 2010 PCB Ref: Issue AD1 DWG No: 4102041-01		Drawn By: Checked By: Date: Issue:	Description of Change



# WIRING DIAGRAM

8200CDQ V12E-Wiring Diagram-P1/1

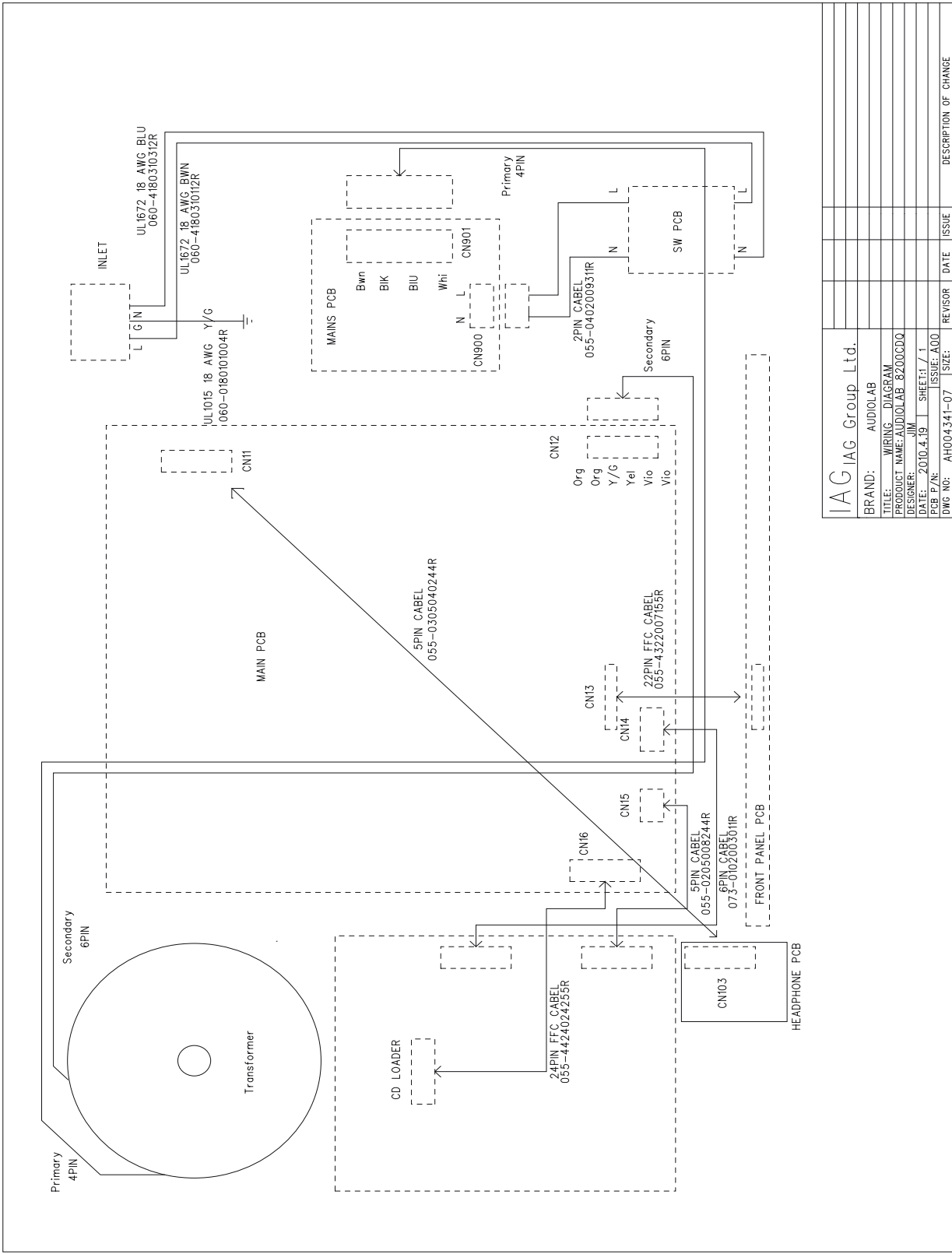

IAG IAG Group Ltd.			
BRAND:	AUDIOLAB	REVISOR	DATE
TITLE:	WIRING DIAGRAM	ISSUE:	A00
PRODUCT NAME:	AUDIOLAB 8200CDQ	SIZE:	
DESIGNER:	JIM		
DATE:	2010.4.19		
PCB D/R:	SHEET 1 / 1		
DRG NO.:	AH004341-07		

8200CDQ V12E-MainBoard-Top- Silkscreen-P1/1

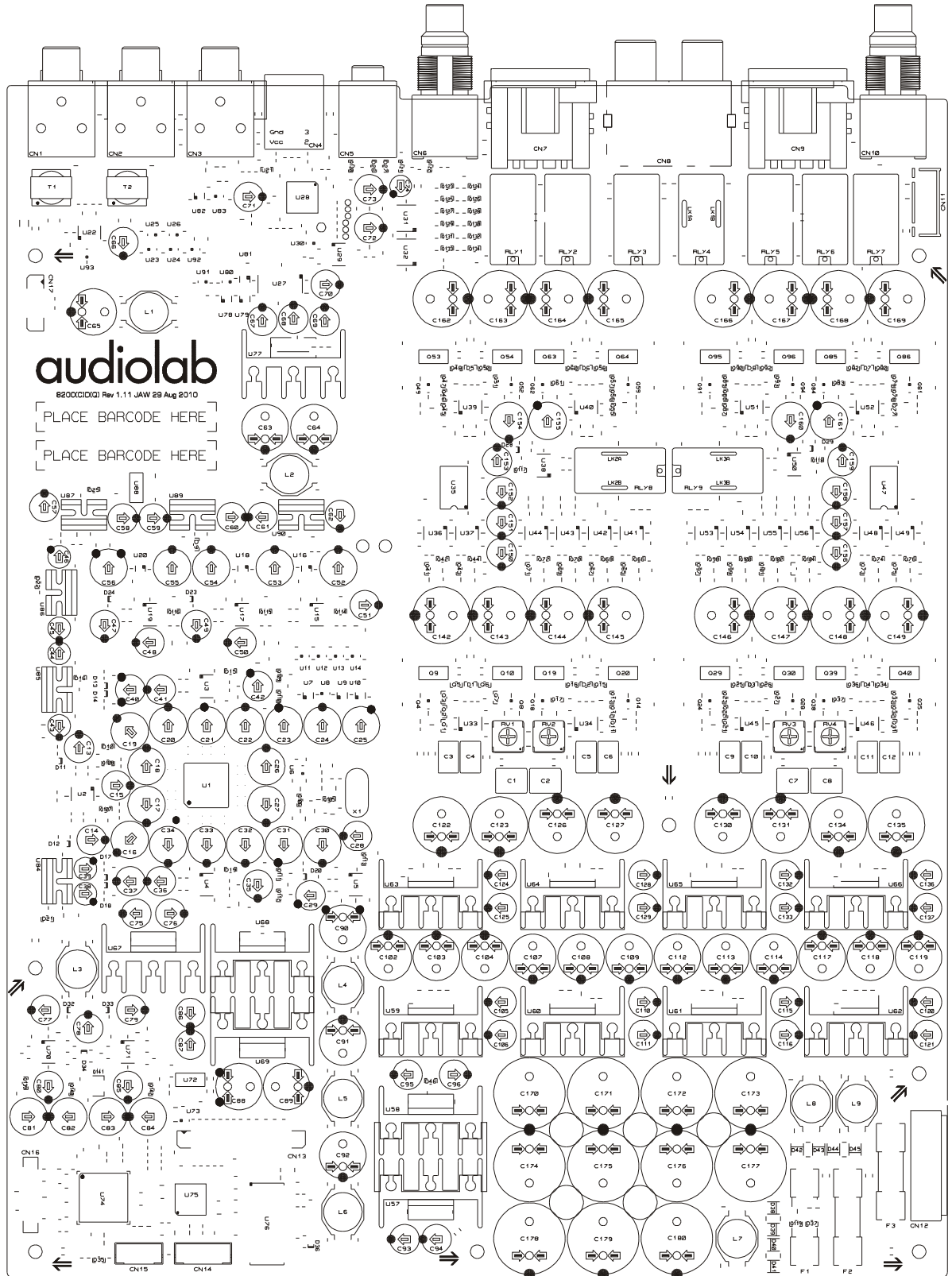

# SILKSCREEN OF TOP / BOTTOM

8200CDQ V12E-MainBoard-SMD- Silkscreen-P1/1

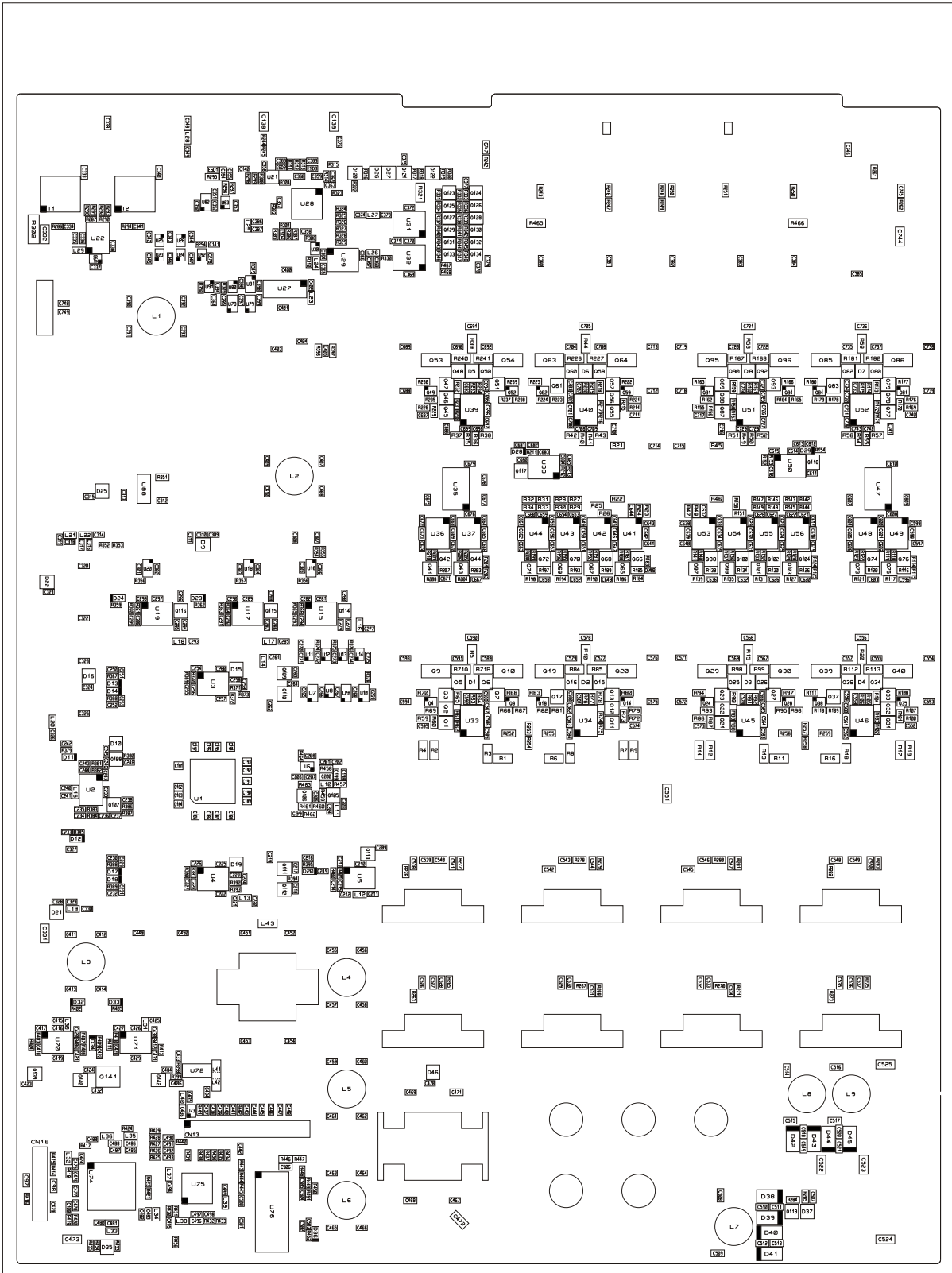

# SILKSCREEN OF TOP / BOTTOM

## 8200CDQ V12E-Front Board-Top - Silkscreen-P1/1

LAYER STACKUP	
Top Layer	FR 4/11.6
Top Silkscreen	COPPER WEIGHT 1 OZ
	LAYERS 2
	RESIST BLUE
	SILKSCREEN WHITE
	MINIMUM WIDTH 0.3mm
	MINIMUM GAP 0.3mm
	PLATING 100U

REV	DATE	ISSUE	DESCRIPTION OF CHANGE
001	2013-03-26	A02	1st issue
002	2013-04-05	A01	Update

Wave Soldering direction

Wave Soldering direction

Wave Soldering direction

Wave Soldering direction

Wave Soldering direction

Wave Soldering direction

Wave Soldering direction

Wave Soldering direction

Wave Soldering direction

V-CUT

V-CUT

V-CUT

**IAG** IAG Group Ltd.

BRAND: AUDIOLAB

TITLE: FRONT PANEL

PRODUCT NAME: 8200CDQ

DESIGNER: Daniel

DATE: 26-AUG-2012

ISSUE: A01

PCB P/N: 051-00472P04B

REV: 001

DATE: 26-AUG-2012

ISSUE: A01

DESCRIPTION: 1st issue

PCB P/N: 051-00472P04B

REV: 001

DATE: 26-AUG-2012

ISSUE: A01

DESCRIPTION: 1st issue

PCB P/N: 051-00472P04B

REV: 001

DATE: 26-AUG-2012

ISSUE: A01

DESCRIPTION: 1st issue

PCB P/N: 051-00472P04B

REV: 001

DATE: 26-AUG-2012

ISSUE: A01

DESCRIPTION: 1st issue

PCB P/N: 051-00472P04B

REV: 001

DATE: 26-AUG-2012

ISSUE: A01

DESCRIPTION: 1st issue





# SILKSCREEN OF TOP / BOTTOM

8200CDQ V12E-Trigger-Top - Silkscreen-P1/1

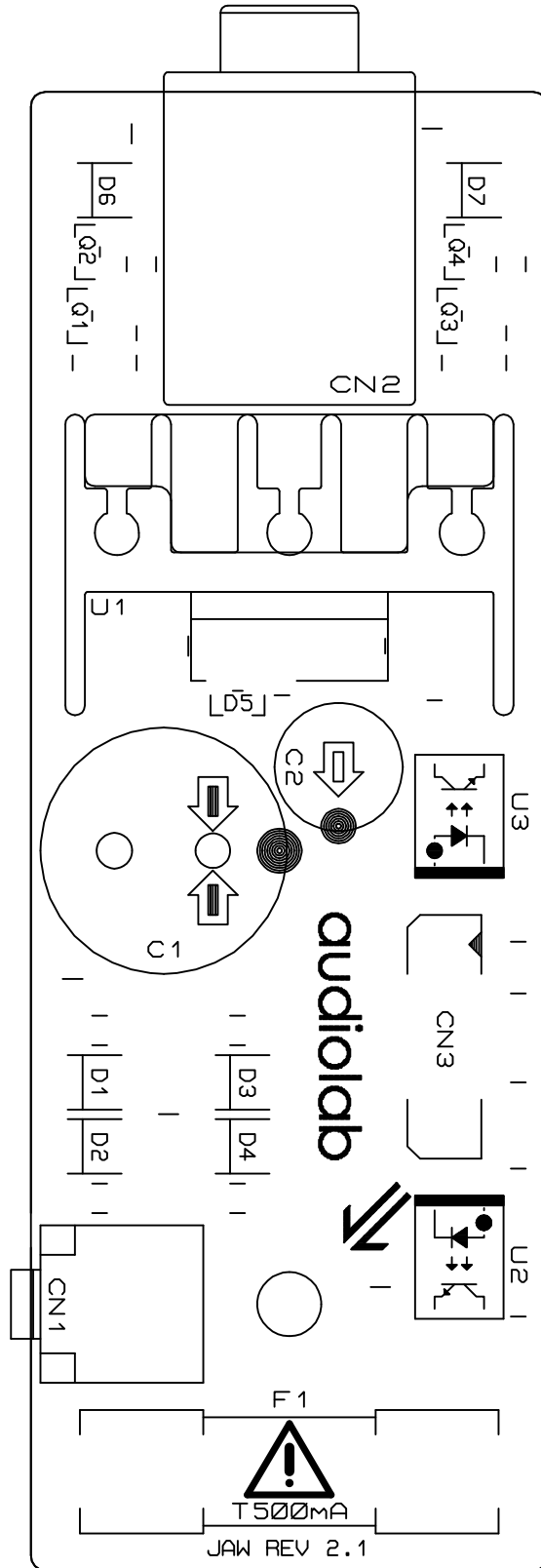

# SILKSCREEN OF TOP / BOTTOM

8200CDQ V12E-Trigger-SMD - Silkscreen-P1/1

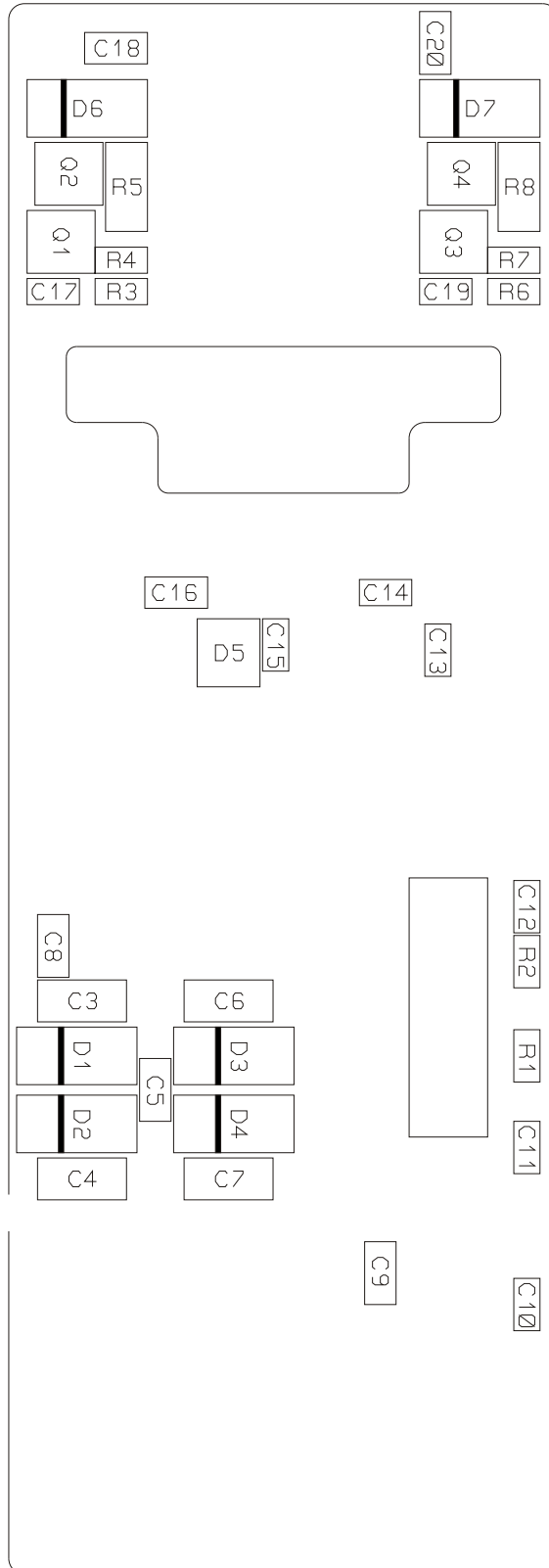



# SILKSCREEN OF TOP / BOTTOM

8200CDQ V12E-OLED-SMD - Silkscreen-P1/1

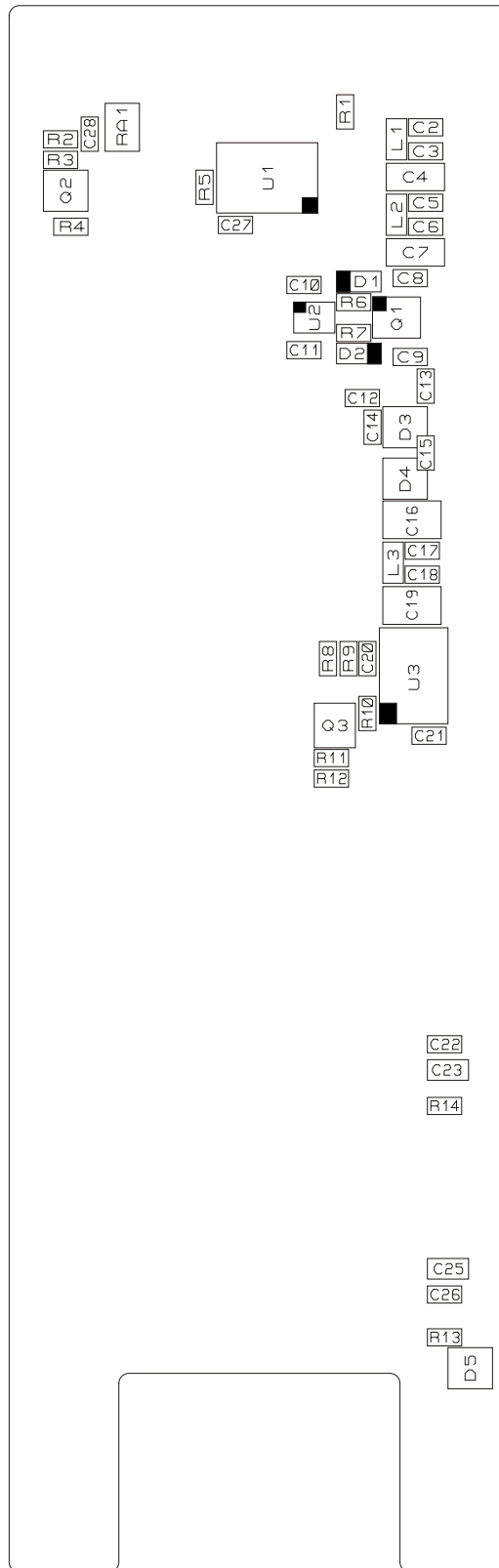

# MAINTENANCE ALIGNMENT PROCEDURE

8200CDQ V12E-Ageing test step-P1/1

Ageing test step	Equipment and Tools
<p>1: Ageing test</p> <p>1):Set the step transformer of AC mains to the rated voltege, the tolerance is 5%.</p> <p>2):After voltage is set correctly, press "EJECT" to put in the disc, and play it repeatedly without stop for 8 hours.</p> <p>2: Take out the disc, switch off the unit after above test is finished, and put "PASSED" mark on the unit.</p>	CD disc
	Step tranformer for AC mains
	Multimeter
<p><b>Notes:</b></p> <p>1.During the ageing, check the voltage every 4 hours to ensure it meets above requiriment.</p>	
<p>2.During the ageing, ensure there is no components smoke、 no electrolytic capacitors bulging or leaking、 no resistors opening、 and no output etc. If there is any above issues happen, switch off the unit immediately. Record the problems and report them to leaders. Fix the trouble and recover aging test.</p>	

## ASSEMBLY PARTS LIST

8200CDQ V12E-Assembly Bom-P1/2

ITEM	P/N	PART NAME	DESCRIPTION	QTY
1	300-1043410000R	Front Panel	finish and anodized	1
2	215-1027410001R	Button Cap	painted	1
3	305-1043410001R	Button Bracket	64*36*4mm,ABS	1
4	231-3007005102R	Rubber Washer	Φ5*Φ7*1mm	6
5	500-3050240300AR	Nut	M3 NI	5
6	340-1020410000R	Function Button	painted	6
7	215-1027410000R	Power Button	painted	1
8	588-3000066037R	Screw	M3*6	16
9	305-1027410002R	Mains Switch Bracket	painted	1
10	421-1140000003R	Ground Sticker	Φ12	1
11	263-0020100102R	EVA	20*10*10 (deep) mm, EVA, with single 3M tape	1
12	604-1043410000R	Heatsink	anodized	8
13	309-1043410001R	Main Chassis	painted and silkscreen	1
14	223-0630120601R	Plastic Post	TP-6	4
15	231-1152070054R	PC Pad	70*152*0.5 (thickness)	1
16	534-3002060021R	Plastic Screw	M3*6	4
17	521-4009050300AR	Washer(lock type)	4*9*0.5mm NI	1
18	262-0500005010R	Dustproof Pad	5*50*0.25mm	16
19	319-1027410001R	Side Panel	sand blasting,anodized	2
20	534-3002061006R	Screw	M3*6	24
21	308-1024000000R	Metal Plate for Main Bracket	SECC 44*23.5*1.5mm	1
22	262-0200013011R	Washer	Φ20*Φ13*2.6MM	2
23	536-4001060301AR	Screw	MB(+)*4*6 NI D	1
24	524-2923090616R	Screw	ST2.9*9.5	7
25	524-2025050601R	Screw	ST2*5	1
26	537-3001060806R	Screw	M3*6	4
27	308-1020410000R	CD Bracket	black painted	1
28	513-6412150780R	Washer	Φ6.4XΦ12X1.5 NI	1
29	071-1313320000R	Cable Tie Mount	13*13*3.2mm	2
30	500-6000000300R	Nut	M6	1
31	537-3001121006R	Screw	M3*12	4
32	517-3000000800AR	Spring Washer	M3	4
33	513-3005050800AR	Washer	Φ3.2*Φ7*0.5 BZn	4
34	711-0081508231R	Spring Washer	Φ1.5*MD8*L15*5N	4
35	226-0230191321R	Feet	Φ23*Φ19*13	4
36	422-0150080102R	Double-sided Tape II	D15*D8.5*0.12mm 3M tape	1
37	206-2024000001R	Transparent Lens	D12*2.5mm	1

## ASSEMBLY PARTS LIST

8200CDQ V12E-Assembly Bom-P2/2

ITEM	P/N	PART NAME	DESCRIPTION	QTY
38	111-0100183000R	Double-sided Tape	34*93*0.12	1
39	206-1020410000R	Lens	34*93*1.5mm,transparent and colorless	1
40	271-0060000000R	Spacer Support	LCI-5,nylon 66	4
41	300-1020410001R	CD Door	finish and anodized	1
42	553-0030040000R	Screw	M3*4 NI	2
43	305-1020410000R	Mains Bracket	painted	1
44	251-2015000200R	EVA	15*1.0mm	0.36
45	302-1043410001R	Top Cover	sand blasting,anodized silver/black	1
46	534-3002100606R	Screw	M3*10	11
47	231-2013005012R	PVC Washer	Φ12.5*Φ4.5*0.1mm	3
48	223-0700220311R	Insulation Post	φ7.5*3.1, nylon66 (UL)	1

Remark:Colour Difference Table

ITEM	P/N	PART NAME	DESCRIPTION	QTY
1	300-1043410000R	Front Panel	screened, light grey(silver anodized)	1
	300-1043420000R		screened, light grey(black anodized)	1
2	215-1027410001R	Button Cap	silver painted,ABS757#	1
	215-1027420001R		black painted,ABS757#	1
6	340-1020410000R	Function Button	silver painted	10
	340-1020410001R		black painted	10
7	215-1027410000R	Power Button	silver painted,ABS757#	1
	215-1027420000R		black painted,ABS757#	1
13	309-1043410001R	Main Chassis	silver painted	1
	309-1043420001R		black painted	1
19	319-1027410001R	Side Panel	sand blasting,anodized silver	2
	319-1027420001R		sand blasting,anodized black	2
20	534-3002061006R	Screw	M3*6NI	21
	534-3002060906R		M3*6Black	21
24	524-2923090616R	Screw	ST2.9*9.5NI	8
	524-2923091016R		ST2.9*9.5Black	8
25	524-2025050601R	Screw	M2*5NI	1
	524-2023061001R		M2*6.5Black	1
41	300-1020410001R	CD door	finish and silver anodized	1
	300-1020420001R		finish and black anodized	1
45	302-1043410001R	Top Cover	sand blasting,anodized silver	1
	302-1043420000R		sand blasting,anodized black	1
46	534-3002100606R	Screw	M3*10NI	13
	534-3002100906R		M3*10Black	12

# ELECTRONIC PARTS LIST

8200CDQ V12E-Electronic Bom-P1/11

ITEM	P/N	PART NAME	DESCRIPTION	QTY	LOCATION
1	062-1318066110R	Mains Cable	PHP-301&PHS-301&SJTAWG	1	
2	742-3500000000R	Heat Shrinkable Tube	φ35MM	0.1	
3	041-1376000000QR	Switch	SWITCH MAINS 2 P SDDSA 3289A	1	
4	060-4180310312R	Wire	UL1672 18 AWG BLUE L=310MM	1	
5	060-4180310112R	Wire	UL1672 18AWG BROWN L=310MM	1	
6	073-0102003011R	CD Work	ASA 8829C+SONY KM-313AAM	1	
7	055-4322007155R	FFC	22PIN, PH=1MM, L=70MM, black	1	
8	055-4424024255R	FFC	24PIN, PH=0.5MM, L=240MM, black	1	
9	022-2000042383-1R	Power Transformer	AUDIOLAB 8200CDQ IN=115V/ 230V OUT1=11.7V OUT2=13.5V*2,14V	1	
10	053-1020410152R	Power Switch PCB	AUDIOLAB8200CDQ PCB 1 layer FR4 1.6 mm	1	
11	008-1003025005R	Capacitor	MKT 10NF/250V 10%	2	
12	055-0402009311R	Cables	2P L=90MM UL1672 18# 3.96mm	1	
13	031-2200504121HR	FUSE	T1A/250V 213 5*20MM LITTELFUSE	1	
14	044-3070000000R	Power Cables	RF-2004-C-4.8 COA 250AC	1	
15	088-1043420000R	PCBA	AUDIOLAB8200CDQ MAIN PCBA	1	
16	604-1043410000R	Radiator	8200CDQ	8	U59 .U60 .U61.U62 .U63 .U64 .U65
17	537-3001060806R	Screw	M3*6	14	
18	277-0010000000R	Transistor Pad	TW-1	14	
19	324-0180130100R	Mica	TO-220 18*13MM	10	U59.U60.U61.U62.U63.U64.U65.U66.U77.U58
20	050-0400000000R	Transistor Fastness	10*6MM BLACK TR-1	6	U84 .U85 .U86 .U87 .U89 .U90
21	323-1117000331R	Crystal Base Insulator	QW-1 4.4*10.8*1.0	1	X1a
22	020-2062117117R	Potentiometer	2M 7*7MM W13323NOXOX-PA1-024	4	RV1.RV2.RV3.RV4
23	006-1014061143-2R	Electrolytic Capacitor	100uF,25V,105DegC,6.3mm Dia,11mmH,5mmPitch,Lelon ,20%	5	C106.C111.C116.C121.C93
24	006-1024080803R	Electrolytic Capacitor	1000uF 4V OCRZ 8*8 20% 105 Lelon	25	C16.C17.C18.C19.C20.C21.C22.C23.C24.C25 .C26.C27.C30.C31.C32.C33.C34.C52.C53.C54.C55.C56.C82.C83.C84
25	006-2214061133R	Electrolytic Capacitor	220uF,16V,105DegC,6.3mm Dia,11mmH,5mmPitch,Lelon ,20%	6	C105.C110.C115.C120.C94.C96
26	006-4714061113R	Electrolytic Capacitor	470uF,6.3V,105DegC,6.3mm Dia,11mmH,5mmPitch,Lelon,20%	28	C13.C14.C152.C153.C158.C159.C29.C36.C37 .C40.C41.C47.C49.C59.C62.C66.C68.C69.C70.C71.C72.C73.C75.C77.
27	016-1031130001R	Foil capacitor	10NF/100V 2.5% EVOX RIFA (PFR5103J100J13L4)	4	C1.C2.C7.C8
28	016-2220802201R	Foil capacitor	Foil 2.2nF 100V 5%	8	C10.C11.C12.C3.C4.C5.C6.C9
29	017-1380000000R	IC	LM317T(1.5A) TO-220 (ST)	5	U60.U61.U64.U65.U77

# ELECTRONIC PARTS LIST

8200CDQ V12E-Electronic Bom-P2/11

ITEM	P/N	PART NAME	DESCRIPTION	QTY	LOCATION
30	017-1390000000R	IC	LM337T(1.5A) TO-220 Fairchild	4	U59.U62.U63.U66
31	017-5440000022R	IC	L7805CV (TO220) ST	7	U67.U84.U85.U86.U87.U89.U90
32	017-5730000000R	IC	17812T 1.5A TO-220 ST	1	U57
33	017-7510000000R	IC	L7808 +8v TO220 ST	3	U58.U68.U69
34	024-1120101011R	Relay	HJR1-2C-12VDC	9	RLY1.RLY2.RLY3.RLY4.RLY5.RLY6.RLY7.RLY8.RLY9
35	031-2200527121HR	FUSE	T1.6A/250V 5*20MM LITTELFUSE	3	F1.F2.F3(A&B)
36	044-5520000000R	USB	UBSRA-004 Gold Plated	1	CN4
37	044-4850000000R	Stereo Jack	Dual 3.5mm RoHS	1	CN5
38	044-4860000000R	RCA + Toslink Combo	JSR1583 16Mbps Optical receiver	2	CN1.CN2
39	044-5500000000R	RCA Jack	1P AEC RJ-255BKPL(PBT)G-TEF-BK	1	CN6
40	044-5510000000R	RCA Jack	1P AEC RJ-255BKPL(PBT)G-TEF-RD	1	CN10
41	044-5550000000R	XLR Jack	PCB Mount 90Deg XLR Jack LX-1601H-3,	2	CN7.CN9
42	044-5690000000R	RCA + Toslink Combo	16Mbps ,JST1583 Optical Transmitter	1	CN3
43	050-0100070211R	Fuse Holder	FUC-2	3	F1(A&B).F2(A&B).F3(A&B)
44	051-7500000000R	RCA Jack	6P(2*3) RED/WHITE Gold Plated	1	CN8
45	056-2105001190R	Type Box Header	5PIN, PH2.0MM, WHITE	1	CN15
46	056-2106001190R	Type Box Header	6PIN, PH2.0MM, WHITE	1	CN14
47	056-0106003300R	Latching Header	6PIN 3.96PH WHITE	1	CN12
48	059-8467202330R	Crystal	Crystal 84.6720MHz AT 5th OT	1	X1
49	056-4105221100R	Latching Header	DJ2802-05	1	CN11
50	006-2224102023R	Electrolytic Capacitor	2200uF,10V,105DegC,10mmDia,20mmH,5mmPitch,Lelon,20%	5	C63.C64.C65.C88.C89
51	006-1024081213R	Electrolytic Capacitor	1000uF,6.3V,105DegC,8mmDia,12mmH,3.5mmPitch,Lelon,20%	5	C81、C15、C28、C35、C42
52	006-3314061123R	Electrolytic Capacitor	330uF,10V,105DegC,6.3mmDia,11mmH,5mmPitch,Lelon,20%	20	C124.C125.C128.C129.C132.C133.C136.C137.C48.C50.C51.C57.C58.C60.C61.C67.C76.C80.C85.C95
53	006-3914081223R	Electrolytic Capacitor	390uF 10V 8mm Dia 12mm H 3.5mm Pitch Lelon OCRZ	8	C138.C139.C140.C141.C154.C155.C160.C161
54	006-1014051123AR	Electrolytic Capacitor	100uF,10V,105DegC,5mmDia,11mmH,2.5mmPitch,Lelon,20%	7	C38.C39.C43.C44.C45.C46.C74
55	006-1014060833R	Electrolytic Capacitor	100uF16V OCRZ 6.3*8 20% 105 Lelon	4	C150.C151.C156.C157
56	006-1024101633AR	Electrolytic Capacitor	1000U/16V ±20% φ 10*16MM Lelon RGA 105℃	3	C90.C91.C92
57	006-4724164043R	Electrolytic Capacitor	4700u/25V 20% Lelon RXY 16*40mm 105°	8	C170 C171 C172 C173 C174 C175 C176 C177
58	006-6824164033R	Electrolytic Capacitor	6800U/16V ±20% φ 16*40MM Lelon RXY 105℃	3	C178 C179 C180
59	006-4724123533R	Electrolytic Capacitor	4700u/16V 20% Lelon RZY 12.5*35mm 105	24	C122 C123 C126 C127 C130 C131 C134 C135 C142 C143 C144 C145 C146 C147 C148 C149 C162 C163 C164 C165 C166 C167 C168 C169
60	006-1224102533R	Electrolytic Capacitor	1200u/16V 20% Lelon RZD 10*25mm 105°	12	C102 C103 C104 C107 C108 C109 C112 C113 C114 C117 C118 C119

# ELECTRONIC PARTS LIST

8200CDQ V12E-Electronic Bom-P3/11

ITEM	P/N	PART NAME	DESCRIPTION	QTY	LOCATION
61	002-3900021010R	SMD Resistor	39R, 1%, 0603, 1/10W	1	R350
62	002-1500021010R	SMD Resistor	15R, 1%, 0603, 1/10W	3	R441.R464.R378
63	002-0000011050R	SMD Resistor	0R 0603 5% 50V	35	R105.R114.R119.R123.R124.R129.R133.R137 .R141.R161.R174.R183.R188.R192.R196.R20 0.R201.R206.R210.R219. R234.R353.R355.R64.R77.R92.R61.R74.R89. R103.R158.R172.R217.R231.R377
64	002-1000011010R	SMD Resistor	10K 1% 0603 50V	42	R153.R213.R316.R317.R318.R319.R335.R336 .R338.R339.R341.R342.R344.R345.R347.R34 8.R361.R364.R366.R370. R371.R373.R380.R382.R384.R391.R392.R394 .R401.R403.R406.R410.R412.R423.R440.R44 2.R444.R453.R454.R332. R333.R455
65	002-1001021010R	SMD Resistor	RES 100 OHM 1/10W 1% 0603	32	R152.R212.R293.R297.R298.R305.R310.R324 .R325.R326.R327.R328.R329.R349.R357.R35 8.R360.R363.R365.R381. R400.R404.R408.R411.R413.R414.R434.R435 .R436.R437.R438.R439
66	002-1001032010R	SMD Resistor	100Ω 1/8W 1% 0805	32	R107.R108.R110.R111.R162.R163.R165.R166 .R176.R177.R179.R180.R221.R222.R224.R22 5.R235.R236.R238.R239. R67.R68.R69.R70.R79.R80.R82.R83.R93.R94 .R96.R97
67	002-1001033010R	SMD Resistor	100R 1% SMD	1	R321
68	002-1001039010R	SMD Resistor	100R MELF CYLINDRICAL 0102 1% 1/8W VISHAY	8	R104.R159.R173.R218.R232.R65.R78.R90
69	002-1002031110R	SMD Resistor	1K MELF CYLINDRICAL 0102 1% 200V 1/8W VISHAY	22	R142.R143.R146.R147.R150.R151.R23.R25.R 26.R27.R28.R31.R32.R35.R36.R40.R41.R47. R49.R50.R54.R55
70	002-1004021010R	SMD Resistor	RES 100K OHM 1/10W 1% 0603	15	R154.R211.R359.R362.R367.R368.R379.R385 .R388.R389.R395.R402.R405.R409.R301
71	002-1004031110R	SMD Resistor	100k MELF CYLINDRICAL 0102 1% 200V 1/8W VISHAY	10	R21.R22.R246.R247.R250.R251.R45.R46.R24 8.R249.
72	002-1005021010R	SMD Resistor	RES 1M OHM 1/10W 1% 0603	2	R330.R417
73	002-1101032010QR	SMD Resistor	SMD 110R 1/8W 1% 0805	1	R295
74	002-1803071010R	SMD Resistor	18K 0603 1% 1/16W	4	R426.R427.R428.R443
75	002-2202021010R	SMD Resistor	RES 2.2K OHM 1/10W 1% 0603	14	R300.R303.R304.R306.R307.R308.R320.R372 .R383.R386.R387.R393.R452.R299
76	002-2203031010R	SMD Resistor	0603 22K 1/8W 1%	2	R418.R425
77	002-2700061010R	SMD Resistor	27R, 1%, 0603, 1/10W	5	R311.R313.R356.R369.R390
78	002-2702032010R	SMD Resistor	2.7KΩ 1/8W 1% 0805	4	R277.R279.R281.R283
79	002-3092061010R	SMD Resistor	3.09K, 1%, 0603, 1/10W	1	R314
80	002-3300011010QR	SMD Resistor	33R 1/16W 1%	1	R374
81	002-3301032010R	SMD Resistor	330Ω 1/8W 1% 0805	1	R459
82	002-3301061010R	SMD Resistor	330R, 1%, 0603, 1/10W	2	R433.R424
83	002-3302061010R	SMD Resistor	3.3K, 1%, 0603, 1/10W	1	R451
84	002-3304061010R	SMD Resistor	330K, 1%, 0603, 1/10W	1	R429
85	002-3901032010R	SMD Resistor	390Ω 1/8W 1% 0805	1	R397
86	002-3902031010R	SMD Resistor	0603 3.9K 1/8W1%	1	R449
87	002-4700021010R	SMD Resistor	47R 0603 1/10W 1%	3	R415.R375.R376
88	002-4700032010R	SMD Resistor	47Ω 1/8W 1% 0805	10	R126.R130.R134.R138.R185.R189.R193.R197 .R203.R207
89	002-4701021010R	SMD Resistor	470R 0603 1/10W 1%	7	R323.R419.R421.R422.R432.R262.R456
90	002-4701032010R	SMD Resistor	470Ω 1/8W 1% 0805	4	R276.R278.R280.R282
91	002-4702021010R	SMD Resistor	RES 4.7K OHM 1/10W 1% 0603	13	R315.R322.R334.R337.R340.R343.R346.R416 .R420.R430.R431.R445.R331

# ELECTRONIC PARTS LIST

8200CDQ V12E-Electronic Bom-P4/11

ITEM	P/N	PART NAME	DESCRIPTION	QTY	LOCATION
91	002-4702021010R	SMD Resistor	RES 4.7K OHM 1/10W 1% 0603	13	R315.R322.R334.R337.R340.R343.R346.R416.R420.R430.R431.R445.R331
92	002-4702032010R	SMD Resistor	4.7K 1/8W 1% 0805	4	R265.R268.R271.R275
93	002-4709049010R	SMD Resistor	4R7 MELF CYLINDRICAL 0204 1% 250V 1/4W	24	R10.R112.R113.R15.R167.R168.R181.R182.R20.R226.R227.R240.R241.R39.R44.R5.R53.R58.R71A.R71B.R84.R85.R98.R99
94	002-5600032010QR	SMD Resistor	56R 1/8W 1% 0603	2	R116.R120
95	002-5601032010R	SMD Resistor	560Ω 1/8W 1% 0805	4	R263.R267.R270.R273
96	002-6801059001R	SMD Resistor	680R 0.1%, 1/4W 0204 MELF	8	R13.R14.R18.R19.R3.R4.R8.R9
97	002-7500021010R	SMD Resistor	75R 1/10W 0603 1%	4	R286.R287.R290.R291
98	002-8202061010R	SMD Resistor	8.2K, 1%, 0603, 1/10W	2	R448.R450
99	002-8200032010R	SMD Resistor	SMD0805 82R 1%	8	R60.R73.R87.R101.R156.R170.R215.R229
100	002-1003039010R	SMD Resistor	10K MELF CYLINDRICAL 0102 1% 200V 1/8W	6	R24.R48.R242.R243.R260.R261
101	002-1804021010R	SMD Resistor	180k 1/10W 0603 1%	4	R288.R289.R292.R293
102	002-1001064010R	SMD Resistor	100Ω MELF 1210 1% 1W	1	R302
103	007-1000001060R	SMD Capacitor	10PF/50V NPO 0603K	3	C334.C341.C199
104	007-1000061060R	SMD Capacitor	10NF 50V X7R 0603 1/16W 10%	32	C201.C215.C228.C235.C244.C256.C284.C292.C300.C302.C304.C306.C355.C390.C392.C403.C407.C409.C411.C413.C455.C457.C459.C461.C463.C465.C467.C480.C482.C485.C487.C497
105	007-1000072060R	SMD Capacitor	10nF, 200V, 0805, X7R, 20%	11	C509.C510.C511.C512.C513.C515.C517.C518.C519.C520.C521
106	007-1000051123R	SMD Capacitor	100pF/250V 5% 0603 COG TDK	8	C588, C580, C566, C558, C694, C703, C723, C734
107	007-1001051060R	SMD Capacitor	100NF 0603 10% Murata 25V	295	C198.C206.C208.C209.C210.C212.C216.C217.C218.C219.C220.C221.C222.C223.C224.C225.C229.C230.C231.C232.C233.C236.C237.C238.C239.C240.C241.C242.C245.C246.C247.C248.C250.C251.C252.C253.C257.C258.C259.C260.C261.C262.C263.C264.C265.C266.C268.C269.C270.C271.C272.C274.C275.C277.C278.C280.C281.C282.C285.C286.C288.C289.C290.C293.C294.C296.C297.C298.C307.C308.C309.C310.C311.C312.C313.C314.C315.C316.C317.C318.C319.C320.C321.C322.C323.C324.C325.C326.C327.C328.C329.C330.C335.C336.C342.C344.C345.C347.C349.C350.C352.C353.C356.C365.C367.C368.C369.C370.C372.C373.C374.C375.C377.C378.C379.C380.C381.C382.C383.C384.C386.C387.C391.C393.C394.C395.C398.C399.C400.C401.C404.C408.C410.C412.C414.C415.C416.C417.C419.C420.C422.C423.C424.C425.C426.C427.C429.C430.C432.C433.C434.C435.C449.C450.C451.C452.C453.C454.C456.C458.C460.C462.C464.C466.C469.C470.C476.C478.C479.C493.C484.C405.C276.C337.C748.C749.C494.C495.C499.C553.C554.C555.C557.C560.C562.C563.C565.C567.C569.C571.C572.C575.C576.C577.C579.C582.C584.C585.C587.C589.C591.C593.C594.C596.C597.C599.C600.C602.C603.C604.C606.C612.C613.C614.C615.C617.C619.C620.C623.C625.C626.C629.C631.C632.C633.C635.C636.C638.C640.C640B.C641.C643.C645.C647.C648.C649.C651.C652.C655.C657.C658.C661.C663.C664.C666.C667.C668.C670.C671.C672.C674.C681.C682.C683.C685.C686.C688.C689.C690.C692.C695.C697.C700.C702.C704.C706.C710.C712.C713.C714.C715.C716.C718.C719.C720.C722.C725.C727.C730.C732.C735.C737.C738.C739.C741.C745.C249.C552.C573.C574.C595.C687.C711.C717.C740.



# ELECTRONIC PARTS LIST

8200CDQ V12E-Electronic Bom-P5/11

ITEM	P/N	PART NAME	DESCRIPTION	QTY	LOCATION
109	007-1001052060QR	SMD Capacitor	100PF50V 5% NPO 0805	4	C637.C644.C746.C747
110	007-1002051063R	SMD Capacitor	1nF 0603 50v 5% COG	6	C205.C362.C484.C498.C99.C100
111	007-1004052060R	SMD Capacitor	100nF 50V 5% 0805	42	C471.C507.C508.C514.C516.C527.C529.C532.C536.C540.C556.C561.C564.C568.C578.C583.C586.C590.C598.C601.C605.C618.C624.C630.C634.C639.C642.C646.C650.C656.C662.C665.C669.C673.C691.C696.C701.C705.C721.C726.C731.C736
112	007-1005051060R	SMD Capacitor	1uF 0603 25v 10% X7R	8	C357.C358.C359.C360.C361.C364.C366.C436
113	007-1005061022R	SMD Capacitor	1U 10V 0306 10% (LWK107B7105KA-T)	17	C181.C182.C183.C184.C185.C186.C187.C188.C189.C190.C191.C192.C193.C194.C195.C196.C197
114	007-1005062090R	SMD Capacitor	1UF/25V 0805 10%	23	C405.C406.C468.C526.C528.C530.C531.C533.C534.C535.C537.C538.C539.C541.C542.C543.C544.C545.C546.C547.C548.C549.C550
115	007-1500001060R	SMD Capacitor	15PF/50V NPO 0603K	1	C202
116	007-2200031061R	SMD Capacitor	0603 22P/50V 5% NPO	28	C211.C279.C287.C295.C388.C389.C607.C609.C611.C621.C622.C627.C628.C653.C654.C659.C660.C675.C677.C680.C698.C699.C708.C709.C728.C729.C742.C743
117	007-2203051061R	SMD Capacitor	0603 22N/50V 5% NPO MURATA	1	C477
118	007-2203063141R	SMD Capacitor	22n/X7R/200V 1206 10%	10	C331.C332.C472.C473.C522.C523.C524.C525.C551.C744
119	007-2205051031R	SMD Capacitor	2.2uF 0603 10V NPO 10%	1	C503
120	007-2206052010R	SMD Capacitor	0805 22U/6.3V X5R 20%	15	C200.C333.C339.C340.C348.C354.C481.C483.C486.C488.C496.C506.C97.C98.C371
121	007-2702051050R	SMD Capacitor	GRM188R71H272KA01D (MURATA)	1	C505
122	007-3009061060R	SMD Capacitor	3P 50V 10% 0603 (EZJZ1V500AA)	3	ESD1.ESD2.ESD3
123	007-3302051050R	SMD Capacitor	GRM188R71H332KA01D (MURATA)	1	C504
124	007-4700051060R	SMD Capacitor	47PF/50V 0603 5%	12	C437.C438.C439.C440.C441.C442.C443.C444.C445.C446.C447.C448
125	007-4703051050R	SMD Capacitor	GRM188R71H473KA01D (MURATA)	1	C475
126	007-4705051010R	SMD Capacitor	0603 4.7U/6.3V 5% MURATA	37	C207.C214.C227.C234.C243.C255.C267.C273.C283.C291.C299.C301.C303.C305.C338.C343.C346.C351.C396.C397.C402.C418.C421.C428.C431.C474.C489.C608.C610.C616.C676.C678.C679.C684.C213.C226.C254
127	007-4708051061R	SMD Capacitor	4.7pF, 50V, 0603, NPO, 5%	9	C204.C559.C570.C581.C592.C693.C707.C724.C733
128	007-6800051060R	SMD Capacitor	0603 680PF 50V5%	2	C490.C491
129	007-8209051063R	SMD Capacitor	8.2pF, 50V, 0603, COG, 5%	1	C203
130	017-1027000000R	IC	LPC2103FBD48 PHILIPS :LQFP48	1	U75
131	017-1055000000R	IC	AM5810FM AMTEK	1	U76
132	017-1056000000R	IC	SAA7824HL LQFP80 NXP	1	U74
133	017-1083000000R	IC	TC74VHC595FT TSSOP16 Toshiba	2	U31.U32

# ELECTRONIC PARTS LIST

8200CDQ V12E-Electronic Bom-P6/11

ITEM	P/N	PART NAME	DESCRIPTION	QTY	LOCATION
134	017-1089000000R	IC	NC7SZ157P6X SC70-6 Fairchild	5	U23.U24.U25.U26.U30
135	017-1091000000R	IC	NE5532D SOIC-8 TI	5	U2.U3.U4.U70.U71
136	017-1092000000R	IC	BC847BS SOT-363 Philips	8	Q14.Q24.Q35.Q4.Q49.Q59.Q81.Q91
137	017-1093000000R	IC	BC857BS SOT-363 Philips	8	Q18.Q28.Q38.Q52.Q62.Q8.Q84.Q94
138	017-1250000000R	IC	NC7SZ74K8X US8 fairchild	10	U10.U16.U18.U20.U7.U78.U79.U81.U82.U9
139	017-1251000000R	IC	NC7SZ04P5 SC70-5 FAIRCHILD	6	U11.U12.U13.U14.U73.U80
140	017-1252000000R	IC	NC7SZ86P5X SC70-5 FAIRCHILD	1	U8
141	017-1253000000R	IC	NC7WZ04P6X SC70-6 FAIRCHILD	2	U6.U83
142	017-1254000000R	IC	TAS1020B TQFP48 TI	1	U28
143	017-1267000000R	IC	AT24C64CN-SH-T SO-8 ATMEL	1	U29
144	017-1292000000R	IC	ES9018 QFP 64 ESS Technologies	1	U1
145	017-1283000000R	IC	ICS525-01, SSOP28 IDT	1	U27
146	017-1309000000R	IC	AD744KR, SO8, ADI	8	U33.U34.U39.U40.U45.U46.U51.U52
147	017-1255000000R	IC	MAS6116 SO16 300MIL Body MAS MIRCO	2	U35.U47
148	017-8160000000R	IC	NE5534D SO-8 W=3.9MM TI	18	U15.U17.U19.U36.U37.U38.U41.U42.U43.U44 .U48.U49.U5.U50.U53.U54.U55.U56
149	017-1391000000R	IC	STC809S SOT23 STC Micro	1	U21
150	067-2200002103R	SMD Diode	S2J Silicon Rectifier Diode 2A 600V, SMA (D0-214)	8	D38.D39.D40.D41.D42.D43.D44.D45
151	018-1400056228QR	SMD Transistor	BCX56 NPN 1W SOT-89	1	Q141
152	018-1400846227R	SMD Transistor	BC846 BLT1 SOT-23 PHILIPS	24	Q119.Q122.Q127.Q129.Q13.Q131.Q133.Q16. Q23.Q26.Q3.Q33.Q36.Q47.Q50.Q57.Q6.Q60. Q79.Q82.Q89.Q92.Q125.
153	018-1400856227R	SMD Transistor	BC856 BLT1 SOT-23	28	Q100.Q101.Q102.Q103.Q104.Q120.Q121.Q15 .Q17.Q25.Q27.Q34.Q37.Q41.Q42.Q43.Q44.Q 48.Q5.Q51.Q58.Q61.Q65
154	018-1500520227R	SMD Transistor	BFR520 SOT23 PHILIPS	2	Q105.Q106
155	018-4302907227AR	SMD Transistor	MMBT2907ALT1G SOT-23 ON	6	Q128.Q130.Q132.Q134.Q126.Q124
156	018-4500690224R	SMD Transistor	FZT690B SOT-223 Zetex	8	Q10.Q19.Q30.Q39.Q54.Q63.Q85.Q96
157	018-4500790224R	SMD Transistor	FZT790A SOT-223 Zetex	8	Q20.Q29.Q40.Q53.Q64.Q86.Q9.Q95
158	018-5600070227R	SMD Transistor	BAV70LT1G SOT-23 ON	1	D35
159	022-1009044385R	SMD Transformer	EI ER9.5	2	T1.T2
160	027-2205918000R	SMD Inductor	22uH, 13x9.5mm, 3316, 20%	5	L5.L6.L7.L8.L9
161	027-1025520000R	SMD Inductor	1000UH 13*9.4MM 3316 20%	4	L1.L2.L3.L4
162	027-3383022000R	SMD Inductor	330nH Wire Wound 0805 5% Inductor	1	L10
163	027-4793022000R	SMD Inductor	4.7uH Wire Wound 0805 5% Inductor	1	L11
164	035-1003062051R	SMD Inductor	1000ohm/100MHz 0805 BLM21BD102SN1D	29	L12.L13.L14.L15.L16.L17.L18.L19.L20.L21.L2 2.L23.L25.L26.L27.L28.L29.L30.L31.L32.L33.L 34.L35.L36.L37.
165	044-4420000000R	FFC Connector	24FLZ-SM2-TB JST 24PIN	1	CN16
166	053-104342D600R	AUDIOLAB8200CD Q MAIN PCB (REV1.11)	4 layer FR4, 1.6MM, 10Z, Blue Solder,	1	PCB
167	044-1003000000R	FFC Connector	SMD PH=1MM PCB 22 in	1	CN13
168	056-9106551184R	FFC Connector	SMD PH=1MM PCB 6Pin	1	CN17

# ELECTRONIC PARTS LIST

8200CDQ V12E-Electronic Bom-P7/11

ITEM	P/N	PART NAME	DESCRIPTION	QTY	LOCATION
169	067-7700099112R	SMD Diode	BAV99 DUAL SOT-23 Philips/nxp	20	D1.D10.D15.D16.D19.D2.D21.D22.D25.D26.D 27.D3.D37.D4.D5.D6.D7.D8.D9.D46
170	002-4700059001R	SMD Resistor	47R 0.1%, 1/4W 0204 MELF	8	R1.R11.R12.R16.R17.R2.R6.R7
171	002-2204031050R	SMD Resistor	RC03K224JT 0603	1	R302
172	007-2201001030R	SMD Capacitor	220NF/16V Y5V 0603K	3	C500.C501.C502
173	007-2204061060R	SMD Capacitor	220NF 50V 0603 10%	1	C492
174	002-2203032010R	SMD Resistor	22K 1/8W 1% 0805	20	R117.R121.R127.R131.R135.R139.R186.R190 .R194.R198.R204.R208.R59.R72.R86.R100.R 155.R169.R214.,R228
175	002-5602032010R	SMD Resistor	5.6KΩ 1/8W 1% 0805	10	R109.R164.R178.R223.R237.R284.R285.R66. R81.R95
176	002-1501032010R	SMD Resistor	150Ω 1/8W 1% 0805	1	R463
177	017-1126000000R	IC	ZHCS400 SOD323 ZETEX	14	D11.D12.D13.D14.D17.D18.D20.D23.D24.D32 .D33.D34.D28.D29
178	067-7700316119R	SMD Diode	BAS316 SOD323 PHILIPS	1	D36
179	002-2201032010R	SMD Resistor	220Ω 1/8W 1% 0805	6	R296.R351.R446.R447.R457.R460
180	002-2200032010R	SMD Resistor	22Ω 1/8W 1% 0805	1	R462
181	002-5601039010R	SMD Resistor	560R MELF CYLINDRICAL 0102 1% 200V 1/8W	8	R29.R30.R33.R34.R144 R145 R148 R149
182	002-5101039010R	SMD Resistor	510R MELF CYLINDRICAL 0102 1% 1/8W	8	R51.R52.R56.R57 R37 R38 R42 R43
183	002-1502021010R	SMD Resistor	RES 1.5K OHM 1/10W 1% 0603	2	R312.R407
184	017-1354000000R	IC	Ti SN65LVDS9637D SO8 ROHS	1	U22
185	002-2261032010R	SMD Resistor	226R, 1%, 0805, 1/8W	1	R396
186	002-1503032010R	SMD Resistor	15K 1/8W 1% 0805	2	R458, R461
187	018-0002222227QR	SMD Transistor	MMBT2222A NPN SMD SOT-23	8	Q114.Q115.Q116.Q117.Q118.Q139.Q140.Q14 2
188	018-1080617227R	SMD Transistor	FMMT617 SOT23 15V 3A 625mW ZETEX	7	Q107, Q108, Q109, Q110, Q111, Q112, Q113
189	017-1295000000R	IC	LM1117MPX-ADJ SOT-223 N03A NS	2	U72.U88
190	088-1043424000R	PCBA	AUDIOLAB8200CDQ Front PCBA	1	
191	006-1014051123AR	Electrolytic Capacitor	100uF, 10V, 105DegC, 5mmDi a, 11mmH, 2.5mmPitch, Lelon , 20%	3	C800.C801.C802
192	039-3000000000R	Tact Switch	TC-17XA 7.8*7.8*5	10	SW1.SW2.SW3.SW4.SW5.SW6.SW7.SW8. SW9.SW10
193	052-2100000000R	Remote Receiver	TSOP4836	1	U101
194	277-0120000000R	Receiver Socket	RCEA-5 NYLON66 (UL) 94V2	2	U101
195	056-4102220000R	Socket	JS-1001-02	1	CN101
196	057-2541202161R	Socket PIN	PH=2.54mm 16pin	1	
197	019-0011022000QR	LED	LED RED	1	
198	055-0302015333R	Cables	2P L=150MM UL1007 24# 2.54MM	1	LED Line
199	044-5750000000R	Stereo Jack	PJ-602-EP	1	
200	056-4105221070R	Socket	PH2.54 5P RoHS H=7MM	1	
201	055-0305040244R	Cable	1007 AWG26,5PIN L=400MM,2.54MM	1	
202	053-104342B648R	AUDIOLAB8200CD Q Front PCB, A02	2Layer FR4, 1.6MM, 10Z	1	PCB
203	007-1001051060R	SMD Capacitor	100NF 0603 10% Murata 25V	5	C803-C805 C812 C834

# ELECTRONIC PARTS LIST

8200CDQ V12E-Electronic Bom-P8/11

ITEM	P/N	PART NAME	DESCRIPTION	QTY	LOCATION
204	007-1002051063R	SMD Capacitor	1nF 0603 50v 5% COG	7	C807 C820 C825 C826 C827 C828 C829
205	007-3300051050R	SMD Capacitor	GRM1885C1H330JA01D (MURATA)	10	C809.C810.C811.C813.C814.C815.C816.C817.C818.C819
206	007-1001031061R	SMD Capacitor	0603 100P/50V 5% MURATA	2	C806.C808
207	007-2203063141R	SMD Capacitor	22n/X7R/200V 1206 10%	4	C830.C831.C832.C833
208	017-5190000013R	IC	P89V51RB2BBC SOT-389-1	1	U100
209	067-7700316119R	SMD Diode	BAS316 SOD323 PHILIPS	1	D100
210	035-1003062051R	SMD Inductor	1000ohm/100MHz 0805 BLM21BD102SN1D	3	L100.L101.L102
211	044-1003000000R	FFC Connector	PH=1MM 22Pin RoHS	1	CN100
212	018-1400856227R	SMD Resistor	BC856 PNP BLT1 SOT-23	3	Q200.Q201.Q202
213	002-3300011010QR	SMD Resistor	33R 1/16W 1%	8	R500 R501 R502 R507 R508 R509 R511 R515
214	002-4702021010R	SMD Resistor	RES 4.7K OHM 1/10W 1% 0603	5	R510 R518 R519 R520 R524
215	002-2002011010R	SMD Resistor	0603 2.2K 1/10W	5	R514.R516.R517.R511.R512
216	002-1802011010R	SMD Resistor	RES 4.7K OHM 1/10W 1% 0603	3	R516 R517 R525
217	002-1004021010R	SMD Resistor	100K OHM 1/10W 1% 0603	3	R512 R521 R522
218	003-3310000005R	SMD Resistor	8P 33R 63MW 1206 5% 3.2*1.6MM	1	RA100
219	017-1159000000R	IC	IMP809LEURT (SOT23)	1	U103
220	018-4302907227AR	SMD Transistor	MMBT2907ALT1G SOT-23 ON	1	Q206
221	018-6200857127R	SMD Transistor	BC857(Pk:SOT23)	1	Q202
222	018-1400856227R	SMD Transistor	BC856 BLT1 SOT-23	1	Q203
223	006-1014051123AR	Electrolytic Capacitor	100uF, 10V, 105DegC, 5mmDia, 11mmH, 2.5mmPitch, Lelon, 20%	3	C800.C801.C802
224	088-1043424001-2R	8200CDQ Front PCBA (OLED)	8200CDQ Front PCBA (OLED)	1	
225	039-3000000000R	Tact Switch	TC-17XA 7.8*7.8*5 RoHS	10	SW1.SW2.SW3.SW4.SW5.SW6.SW7.SW8.SW9.SW10
226	052-2100000000R	Remote Receiver	TSOP4836	1	U101
227	277-0120000000R	Receiver Socket	RCEA-5 NYLON66 (UL) 94V2	2	U101
228	056-4102220000R	Socket	JS-1001-02	1	CN101
229	057-2541202161R	Socket PIN	PH=2.54mm 16pin	1	
230	019-0011022000QR	LED	LED RED	1	
231	055-0302015333R	Cables	2P L=150MM UL1007 24# 2.54MM	1	
232	044-5750000000R	Stereo Jack	PJ-602-EP CHUNSHENG	1	
233	056-4105221070R	Socket	PH2.54 5PIN WHITE RoHS H=7MM	1	
234	055-0310030133R	Cables	1007 AWG26, 5PIN L=500MM, BLACK Cables 2.54MM	1	
235	007-1001051060R	SMD Capacitor	100NF 0603 10% Murata 25V	5	C803-C805 C812 C834
236	007-1002051063R	SMD Capacitor	1nF 0603 50v 5% COG	11	C807 C820 C821 C822 C823 C824 C825 C826 C827 C828 C829
237	007-3300051050R	SMD Capacitor	GRM1885C1H330JA01D (MURATA)	10	C809.C810.C811.C813.C814.C815.C816.C817.C818.C819
238	007-1001031061R	SMD Capacitor	0603 100P/50V 5% MURATA	2	C806.C808
239	007-2203063141R	SMD Capacitor	22n/X7R/200V 1206 10%	4	C830.C831.C832.C833

# ELECTRONIC PARTS LIST

8200CDQ V12E-Electronic Bom-P9/11

ITEM	P/N	PART NAME	DESCRIPTION	QTY	LOCATION
239	007-2203063141R	SMD Capacitor	22n/X7R/200V 1206 10%	4	C830.C831.C832.C833
240	007-1003073060R	SMD Capacitor	10nF 20% 1206	1	C838
241	017-5190000013R	IC	P89V51RB2BBC SOT-389-1	1	U100
242	067-7700316119R	SMD Diode	BAS316 SOD323 PHILIPS	1	D100
243	035-1003062051R	SMD Inductor	1000ohm/100MHz 0805 BLM21BD102SN1D	3	L100.L101.L102
244	044-1003000000R	FFC Connector	PH=1MM 22Pin RoHS	1	CN100
245	018-1400856227R	SMD Resistor	BC856 PNP BLT1 SOT-23	3	Q200.Q201.Q202
246	002-3300011010QR	SMD Resistor	33R 1/16W 1%	8	R500 R501 R502 R507 R508 R509 R511 R515
247	002-4702021010R	SMD Resistor	RES 4.7K OHM 1/10W 1% 0603	5	R510 R518 R519 R520 R524
248	002-2002011010R	SMD Resistor	0603 2.2K 1/10W	5	R514.R516.R517.R511.R512
249	002-1802011010R	SMD Resistor	RES 4.7K OHM 1/10W 1% 0603	3	R516 R517 R525
250	002-1004021010R	SMD Resistor	100K OHM 1/10W 1% 0603	3	R512 R521 R522
251	003-3310000005R	SMD Resistor	8P 33R 63MW 1206 5% 3.2*1.6MM	1	RA100
252	017-1159000000R	IC	IMP809LEURT (SOT23)	1	U103
253	018-4302907227AR	SMD Transistor	MMBT2907ALT1G SOT-23 ON	1	Q206
254	018-6200857127R	SMD Transistor	BC857(PK:SOT23)	1	Q202
255	018-1400856227R	SMD Transistor	BC856 BLT1 SOT-23	1	Q203
256	053-104342B648R	AUDIOLAB8200CD Q FRONTPCB, A02	2 Layer FR4, 1.6MM, 1OZ. , Blue Solder,	1	PCB
257	088-1047418480R	OLED PCBA	OLED PCBA	1	
258	006-1014061143-2R	Electrolytic Capacitor	100uF,25V,105DegC,6.3mm Dia,11mmH,5mmPitch,Lelon ,20%	1	C1
259	030-7127000000R	OLED display	Character 2*20 UC- 2002ASWAG01 White Univision / Wisechip	1	OLED1
260	057-2541920325R	Pin-header	16pin PH=2.54mm L=19MM	1	
261	307-1300600121R	Copper pillar	M3*12	4	
262	534-3002061006R	Screw	M3*6	8	
263	405-2101037034R	Sponge	101.2*37.2*3mm	1	
264	053-1047410686R	OLED PCB	2Layer 1oZ FR4 1.6MM	1	
265	017-0211000000R	IC	74VHC393MTC TSSOP14 Fairchild	1	U1
266	017-1253000000R	IC	NC7WZ04P6X SC70-6 FAIRCHILD	1	U2
267	017-0211300000R	IC	LP2951 SO8 ADJ 100mA ON(CDR2G) Fairchild(CM)	1	U3
268	018-7206602135R	Transistor	AO6602 MOSFETS 70mR / 170mR 30V TSOP6 ALPHA & OMEGA	1	Q1
269	018-1400856227R	Transistor	BC856 BLT1 SOT-23	1	Q2
270	018-1400846227R	Transistor	BC846 BLT1 SOT-23 PHILIPS	1	Q3
271	017-1126000000R	IC	ZHCS400 SOD323 ZETEX	2	D1 D2
272	067-7700099112R	Diode	BAV99 DUAL SOT-23 Philips/nxp	2	D3 D4
273	003-1003084005R	Resistor	10KQ 4IN1206	1	RA1
274	002-5600011010R	Resistor	RC03K560JT 56R 0603 1%	2	R5 R6
275	002-1203021010R	Resistor	RES 12K OHM 1/10W 1% 0603	6	R2 R3 R4 R8 R11 R12

# ELECTRONIC PARTS LIST

8200CDQ V12E-Electronic Bom-P10/11

ITEM	P/N	PART NAME	DESCRIPTION	QTY	LOCATION
276	002-3300011010QR	Resistor	33R 1/16W 1%	1	R7
277	002-1004021010R	Resistor	RES 100K OHM 1/10W 1% 0603	3	R1 R9 R10
278	007-1000061060R	Capacitor	10NF 50V X7R 0603 1/16W 10%	1	C20
279	007-1005051040R	Capacitor	1U/25V X5R 10% Murata	3	C13~15
280	007-0470074034R	Capacitor	47uF 16V 1210 X5R ±20% GRM32ER61C476ME15L MURATA	2	C16 C19
281	007-1006072034R	Capacitor	10uF 16V 20% X5R 0805	1	C23
282	007-1001051060R	Capacitor	100NF 0603 10% Murata 25V	16	C2 C3 C5 C6 C8~C12 C17 C18 C21 C22 C26~C28
283	002-4704011050R	Resistor	RC03K474JT 470K 0606 1%	1	R14
284	035-1003062051R	Inductor	1000ohm/100MHz 0805 BLM21BD102SN1D	3	L1~L3
285	007-2206052010R	Capacitor	0805 22U/6.3V X5R 20%	1	C25
286	007-1000073010R	Capacitor	100uF/6.3V 1206 X5R ±20% GRM31CR60J107M MURATA	2	C4 C7
287	088-1043413400R	8200CDQ Trigger PCBA	8200DQ Trigger PCBA	1	
288	055-4306006166R	FFC	6Pin L=65MM C type 1.0MM 80°C black	1	
289	537-3001060301AR	Screw	MP(+)*3*6 NI D	1	
290	050-0100070211R	Fuse Holder	FUC-2	2	F1(A&B)
291	846-0010000001R	Fuse Holder	FUSE-1 (20*11*6MM)	1	F1
292	082-0100000000R	Opto-electrical	PC-17K1 KODENSHI	2	U2.U3
293	006-2214061133R	Electrolytic Capacitor	220uF,16V,105DegC,6.3mm Dia,11mmH,5mmPitch,Lelon ,20%	1	C2
294	006-2224122543-1R	Electrolytic Capacitor	2200U/25V ±20% φ 12.5*25MM Lelon RGA 105 °C	1	C1
295	056-0102224400R	Connector	JS3962-2P-WAFER	1	CNI
296	044-4850000000R	Dual 3.5mm Stereo Jack	Dual Vertical PCB Mount 3.5mm	1	CN2
297	017-1240000000R	IC	L7812CV TO-220 (ST)	1	U1
298	031-2200502121HR	Fuse	T500MA/250V 213 5*20MM LITTELFUSE	1	
299	604-1020410000R	Heatsink	H45mm x W23mm x D15.5mm	1	
300	053-1043410034R	8200DQ Trigger PCB	2Layer 26*76*1.6mm 1oZ FR4	1	
301	056-9106551184R	Connector	6W, 0.156th Pitch Latching Header	1	CN3
302	067-7700001103R	Diode	S1J DO-214AC Fairchicd	6	D1,D2,D3,D4,D6,D7
303	067-7700099112R	Diode	BAV99 DUAL SOT-23 Philips/nxp	1	D5
304	018-1080617227R	Transistor	FMMT617 SOT23 15V 3A 625mW ZETEX	2	Q1.Q3
305	018-0002222227QR	Transistor	MMBT222A NPN SMD SOT-23	2	Q2.Q4
306	007-2203063141R	Capacitor	22n/X7R/200V 1206 10%	4	C3,C4,C6,C7
307	007-1000072060R	Capacitor	10nF, 200V, 0805, X7R, 20%	4	C5.C9.C18.C20
308	002-2201021010R	Resistor	220R 0603 1/10W 1%	2	R1.R2
309	002-4702021010R	Resistor	RES 4.7K OHM 1/10W 1% 0603	2	R4.R7

# ELECTRONIC PARTS LIST

8200CDQ V12E-Electronic Bom-P11/11

ITEM	P/N	PART NAME	DESCRIPTION	QTY	LOCATION
310	002-4703021010R	Resistor	47K1/8W1% 0603	2	R3.R6
311	007-1001051060R	Capacitor	100NF 0603 10% Murata 25V	8	C10--C15.C17.C19
312	007-1004052060R	Capacitor	100nF 50V 5% 0805	2	C8.C16
313	002-4702033010R	Resistor	4R7 1206 1/8W 1%	2	R5.R8

## COUNTRY BOM DEVIATION

8200CDQ V12E-Country Bom Deviation-P1/1

ITEM	UNIT CODE	COUNTRY	P/N	PART NAME	DESCRIPTION	QTY
1	AH-004341-01B	CH	062-5318000100R	Power Cord	Black, L=1.8M 0.75mm2,3C approve	1
	AH-004342-01B		031-2200504121HR	Fuse	T1A 250V 5*20MM UL LITTLE FUSE	2
2	AH-004341-02B	USA	062-1318066110R	Power cord	Black PHP-301&PHS-301&SJTAWG	1
	AH-004342-02B		031-2200527121HR	Fuse	T1.6A 250V 5*20MM UL LITTLE FUSE	2
3	AH-004341-03B	UK	062-9318000110R	Power Cord	Black,H03VV-F3G 0.75mm ,L=1.8M	1
	AH-004342-03B		031-2200504121HR	Fuse	T1A 250V 5*20MM UL LITTLE FUSE	2
4	AH-004341-05B	AU	062-6318000110R	Power Cord	Black,PHS-301&GTSA-3 3G0.75mm2	1
	AH-004342-05B		031-2200504121HR	Fuse	T1A 250V 5*20MM UL LITTLE FUSE	2
5	AH-004341-06B	TW	062-7318000110R	Power Cord	3G0.75MM2 VDE L=1.8M	1
	AH-004342-06B		031-2200527121HR	Fuse	T1.6A 250V 5*20MM UL LITTLE FUSE	2
6	AH-004341-07B	FG	062-2318000110R	Power Cord	Black,H05VV-F3G0.75mm2,L=1.8M	1
	AH-004342-07B		031-2200504121HR	Fuse	T1A 250V 5*20MM UL LITTLE FUSE	2



audiolab

UK: IAG House, Sovereign Court, Ermine Business Park, Huntingdon, Cambs, PE29 6XU, UK  
UK : Tel: + 44 (0) 1480 447700. Fax: + 44 (0) 1480 431767, [www.audiolab.co.uk](http://www.audiolab.co.uk)  
CHINA: Sanecore Industrial Park, Jiuwei, Xixiang, Shenzhen, China 518102  
CHINA: Tel: + 86-755-2748-4420. Fax: + 86-755-2965-1484  
The information in this service manual is subject to change without notice.  
All rights reserved © IAG Group Ltd. Audiolab is a member of the IAG Group.