

AN2514S

Electronic View-finder Driving IC with Synchronous Signal

Overview

The AN2514S is an integrated circuit designed for driving the monochrome monitor (view finder) of the video camera, and its idling current of the vertical driving circuit is increased from that of the AN2513S, and it is possible to easily make up a 1.5-inch electronic view finder driving circuit by inputting a video signal. VD output is available for timing-reference of character.

Features

- Video amp, synchronous separation circuit, horizontal/vertical oscillation circuit, AFC circuit, and vertical driving circuit built-in
- A vertical deflection coil can be driven directly.
- Horizontal oscillating capacitors built-in

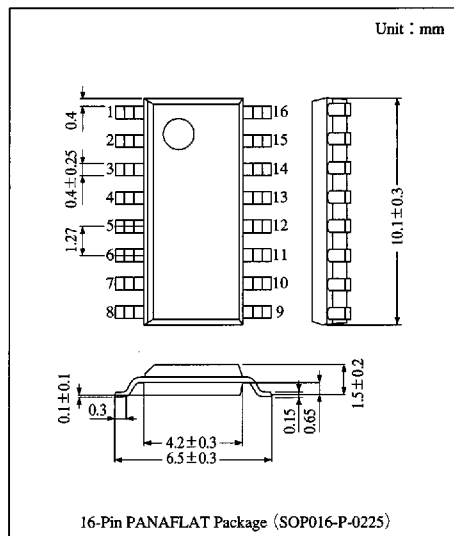

Block Diagram

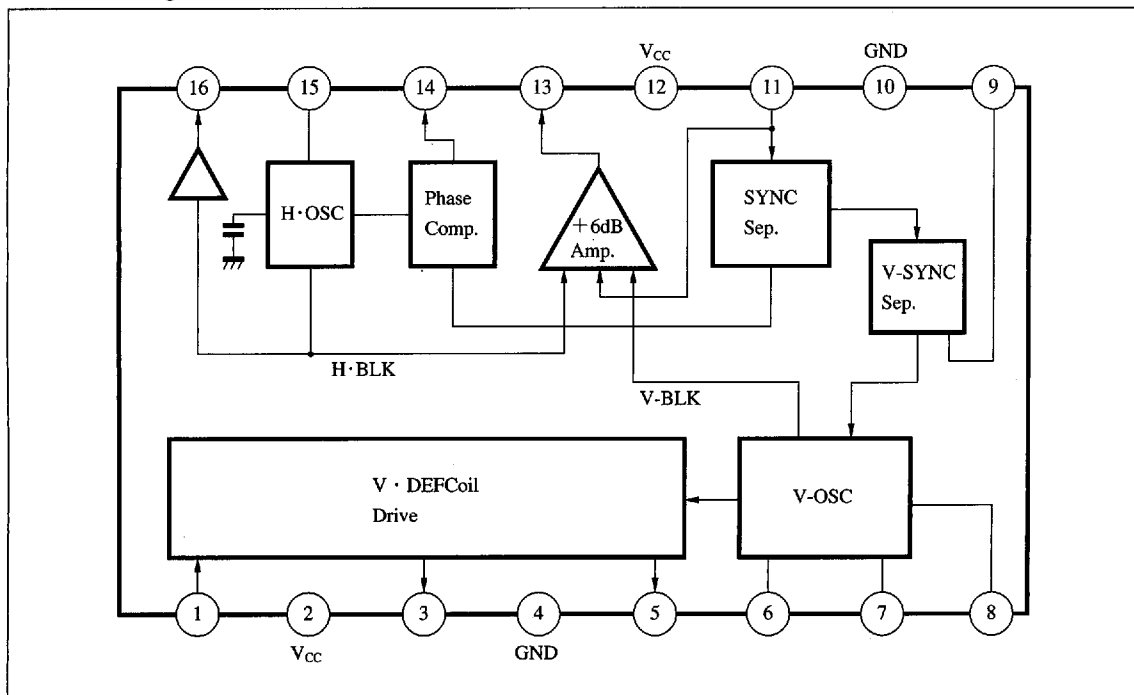

6932852 0014683 950

Absolute Maximum Ratings (Ta=25°C)

Parameter	Symbol	Rating	Unit
Supply voltage	V _{CC1} /V _{CC2}	5.5	V
Power dissipation (Ta=75°C)	P _D	260 *	mW
Operating ambient temperature	T _{opr}	-20 to +75	°C
Storage temperature	T _{stg}	-55 to +125	°C

* Value when mounted on the printed circuit board

Recommended Operating Range (Ta=25°C)

Parameter	Symbol	Range
Operating supply voltage range	V _{CC1} , V _{CC2}	4.5V to 5.3V

Electrical Characteristics (V_{CC1}=5V, V_{CC2}=5V, Ta=25°C)

Parameter	Symbol	Condition	min	typ	max	Unit
Circuit current	I _{CC1(2)}	No load	2.35	7.5	13	mA
	I _{CC2(10)}		5.5	10	14	mA
Video amp gain	G _v	Input a video signal (1V _{PP}) to Pin ^⑨ , measure the output of Pin ^⑪	5.1	6.5	7.9	dB
Video amp dynamic range	DR _v	Input a video signal (1.3V _{PP}) to Pin ^⑨ , measure the output of Pin ^⑪	1.7	2.1	2.5	V
Synchronous separating capability (1)	HSep1	Input only SYNC to Pin ^⑨ and measure the minimum level at which synchronization is provided.	0.2	—	—	V
Synchronous separating capability (2)	HSep2	Input SYNC (0.29V _{PP}) plus video component to Pin ^⑨ and measure the maximum video level at which synchronization is provided.	—	—	1.3	V
Video signal HD width	τ _{HD}	Measure the time from the falling of input HD to blanking OFF of Pin ^⑪ output.	7.5	8.5	9.5	μs
AFC output HD width	τ _{AFC} HD	Input a signal to Pin ^⑨ and measure while Pin ^⑭ is Lo.	10.5	11.5	12.5	μs
Horizontal free-oscillation frequency	f _{HO}	Measure the output frequency of Pin ^⑭ in the horizontal free-oscillation mode.	13.75	15.75	17.75	kHz
AFC lock range	f _{AFC}	Change the frequency of input signal to Pin ^⑨ and measure the synchronizing frequency.	15.25	15.75	16.25	kHz
AFC control sensitivity	β	Flow in and out current to Pin ^⑬ and measure the difference in frequency of Pin ^⑭ output.	720	840	960	Hz/μA
Vertical separating time	t _{Vsep}	Input a signal from Pin ^⑨ and measure the difference in falling between Pin ^⑮ output and input VD.	30	50	70	μs
Video signal VD width	τ _{VOUT}	Measure the time from the falling of input VD signal to blanking OFF of Pin ^⑪ output.	1	1.2	1.4	ms
Vertical free-oscillation frequency	f _{VO}	Measure the oscillation frequency of Pin ^⑮ in the vertical free-oscillation mode.	47	51	55	Hz
Vertical deflection output amplitude (1)	v _{VDEF(1)}	Input a signal (1V _{PP}) from Pin ^⑨ and measure the output of Pin ^⑤ .	1.3	1.6	1.9	V
Vertical deflection output amplitude (2)	v _{VDEF(2)}	Input a signal (1V _{PP}) from Pin ^⑨ and measure the output of Pin ^③ .	1.3	1.6	1.9	V
Vertical output dynamic range (1)	DR _{VDEF(1)}	Input a signal (1V _{PP}) from Pin ^⑨ and measure the output of Pin ^⑤ .	2	2.4	2.8	V
Vertical output dynamic range (2)	DR _{VDEF(2)}	Input a signal (1V _{PP}) from Pin ^⑨ and measure the output of Pin ^③ .	2	2.4	2.8	V
VD width	τ _{VD}	Input a signal to Pin ^⑨ and measure while Pin ^③ is Lo.	800	900	1000	μs

■ Application Circuit

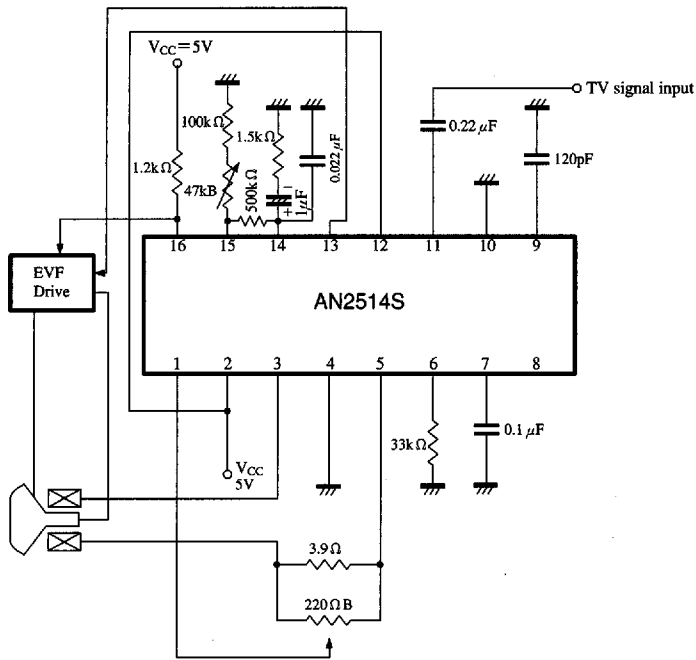





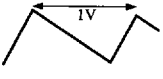
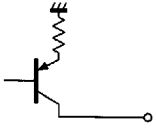
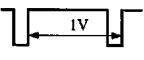
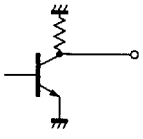

■ Pin Descriptions

Pin No.	Pin name	Typ. waveform	Description	Equivalent circuit
1	Vertical size control input		Control the V size of the vertical deflection coil driving pin.	
2	Power pin		Vertical deflection driving circuit V _{CC} .	
3	Vertical deflection coil driving Pin①		Vertical deflection coil driving output.	
4	GND		Vertical deflection driving circuit GND.	
5	Vertical deflection coil driving Pin②		Vertical deflection coil driving output (inversion of Pin③).	
6	Vertical oscillating resistance pin		Vertical oscillating resistor pin.	

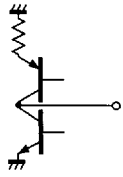
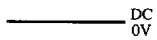
■ 6932852 0014685 723 ■

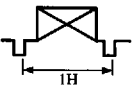
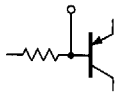
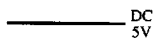
■ Pin Descriptions (cont.)

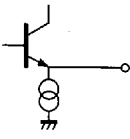
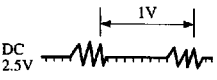
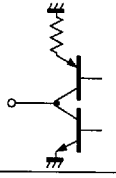
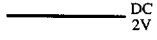
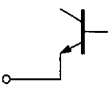
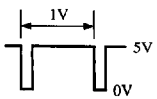
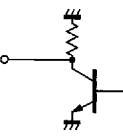
Pin No.	Pin name	Typ. waveform	Description	Equivalent circuit
7	Vertical oscillating capacitor pin		Determine the vertical free-oscillation frequency by the resistor of Pin⑥ and capacitor of Pin⑦.	
8	V _D output pin		Pulse output synchronized with a vertical oscillation waveform.	
9	Vertical synchronous separating capacitor pin		Charges and discharges the vertical synchronous separating capacitor.	
10	GND		Main circuit GND	
11	Video input		Clamped to the video signal input pin (1.6V).	
12	Power pin		Main circuit V _{CC} .	
13	Video amp output pin		Amplified to the video amp signal output (6.5dB).	
14	Phase comparator output		The output DC of the phase comparator changes and AFC operates.	
15	Horizontal oscillating resistor pin		Horizontal free-oscillation frequency determining resistor.	
16	Horizontal AFC output		A pulse waveform synchronized with a horizontal oscillation waveform is output.	

ICs for Video Camera

■ 6932852 0014686 66T ■

Panasonic

■ Supplementary Explanation

• Precautions on Use

1. Horizontal free oscillation frequency adjusting method

The frequency of Pin¹⁵ should essentially be adjusted to 15.75Hz by the counter, changing the resistor of Pin¹⁵ at no signal input. But this causes the voltage of Pin¹⁴ (AFC detecting pin) to be about 2V when a signal is input. Because supply voltage is 5V (typ.), it is desirable to use a digital voltmeter so that the voltage of Pin¹⁴ may be 2.5V, considering dispersion, etc.

2. External constant of Pin¹⁵

The following value is recommended to take in the dispersion of horizontal free oscillation frequency of IC.

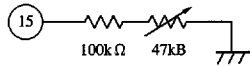

3. Vertical oscillating R.C

High-precision parts should be used for the grounding resistor of Pin⁶ and grounding capacitor of Pin⁷ which determine vertical free-oscillation frequency. Because of 54Hz (typ.) at $C_7=0.1\mu\text{F}$ and $R_6=30\text{k}\Omega$, the value of R_6 is desirable to be 33 to 36kΩ, considering the dispersion and temperature characteristics of IC in order not to be out of vertical synchronization.

4. Power filter

It is recommended to use the following filter for power pins of Pins² and ¹², to prevent from being out of vertical synchronization and horizontal noise. C_2 of good temperature characteristics should be used.

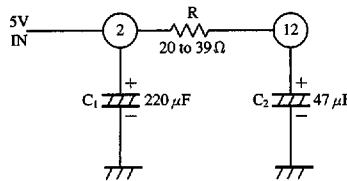

• Characteristic Curve

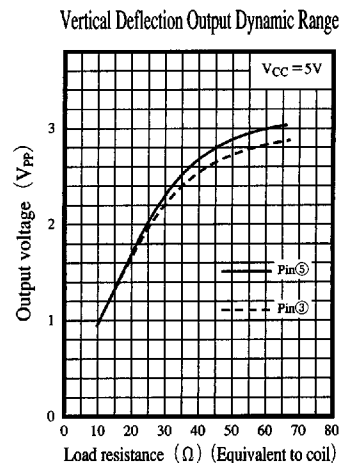
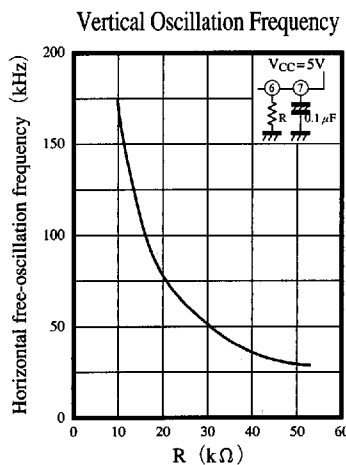
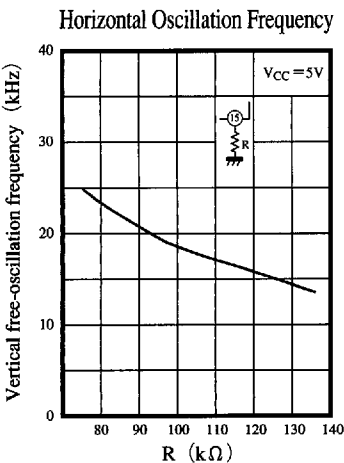

This datasheet has been downloaded from:

www.DatasheetCatalog.com

Datasheets for electronic components.