



60EPU04PbF 60APU04PbF

Ultrafast Soft Recovery Diode

Features

- Ultrafast Recovery
- 175°C Operating Junction Temperature
- Lead-Free ("PbF" suffix)

Benefits

- Reduced RFI and EMI
- Higher Frequency Operation
- Reduced Snubbing
- Reduced Parts Count

Description/ Applications

These diodes are optimized to reduce losses and EMI/ RFI in high frequency power conditioning systems. The softness of the recovery eliminates the need for a snubber in most applications. These devices are ideally suited for HF welding, power converters and other applications where switching losses are not significant portion of the total losses.

$$t_{rr} = 50\text{ns (typ)}$$

$$I_{F(AV)} = 60\text{Amp}$$

$$V_R = 400\text{V}$$

Absolute Maximum Ratings

Parameters	Max	Units
V_R Cathode to Anode Voltage	400	V
$I_{F(AV)}$ Continuous Forward Current, $T_C = 127^\circ\text{C}$	60	A
I_{FSM} Single Pulse Forward Current, $T_C = 25^\circ\text{C}$	600	
$I_{FRM} \text{ } \textcircled{1}$ Maximum Repetitive Forward Current	120	
T_J, T_{STG} Operating Junction and Storage Temperatures	- 55 to 175	$^\circ\text{C}$

$\textcircled{1}$ Square Wave, 20kHz

Case Styles

60EPU04PbF

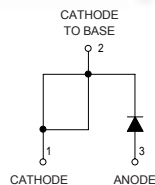

TO-247AC (Modified)

60APU04PbF

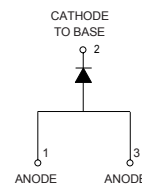

TO-247AC

Electrical Characteristics @ T_J = 25°C (unless otherwise specified)

Parameters	Min	Typ	Max	Units	Test Conditions
V _{BR} , V _r Breakdown Voltage, Blocking Voltage	400	-	-	V	I _R = 100μA
V _F Forward Voltage	-	1.05	1.25	V	I _F = 60A
	-	0.87	1.03	V	I _F = 60A, T _J = 175°C
	-	0.93	1.10	V	I _F = 60A, T _J = 125°C
I _R Reverse Leakage Current	-	-	50	μA	V _R = V _R Rated
	-	-	2	mA	T _J = 150°C, V _R = V _R Rated
C _T Junction Capacitance	-	50	-	pF	V _R = 400V
L _S Series Inductance	-	3.5	-	nH	Measured lead to lead 5mm from package body

Dynamic Recovery Characteristics @ T_J = 25°C (unless otherwise specified)

Parameters	Min	Typ	Max	Units	Test Conditions	
t _{rr} Reverse Recovery Time	-	50	60	ns	I _F = 1A, di _F /dt = 200A/μs, V _R = 30V	
	-	85	-		T _J = 25°C	
	-	145	-		T _J = 125°C	
I _R Peak Recovery Current	-	8.8	-	A	I _F = 60A V _R = 200V di _F /dt = 200A/μs	
	-	15.4	-			T _J = 125°C
Q _{rr} Reverse Recovery Charge	-	375	-	nC		T _J = 25°C
	-	1120	-			T _J = 125°C

Thermal - Mechanical Characteristics

Parameters	Min	Typ	Max	Units
R _{thJC} Thermal Resistance, Junction to Case			0.70	K/W
R _{thCS} ② Thermal Resistance, Case to Heatsink		0.2		
Wt Weight		5.5		g
		0.2		(oz)
T Mounting Torque	1.2 (10)		2.4 (20)	N*m (lbf.in)
Marking Device	60EPU04, 60APU04			

② Mounting Surface, Flat, Smooth and Greased

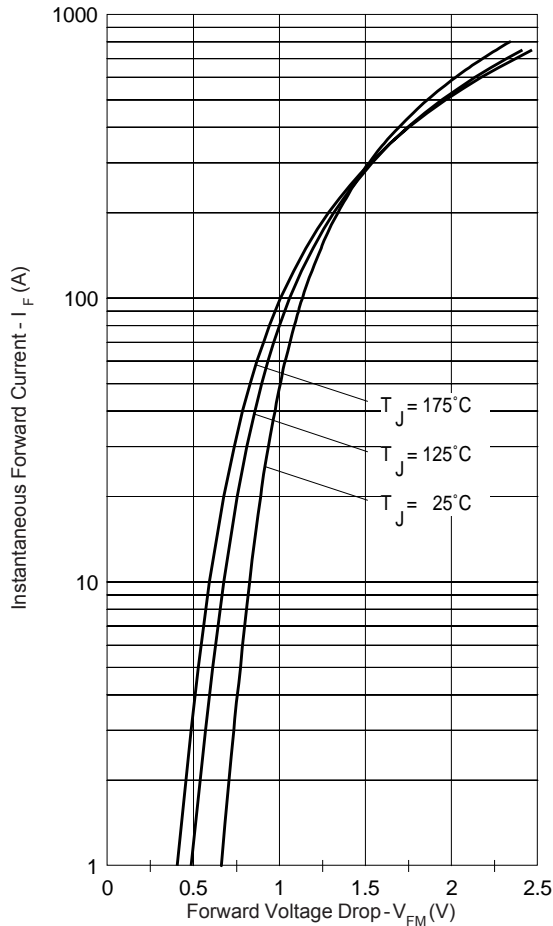

Fig. 1 - Typical Forward Voltage Drop Characteristics

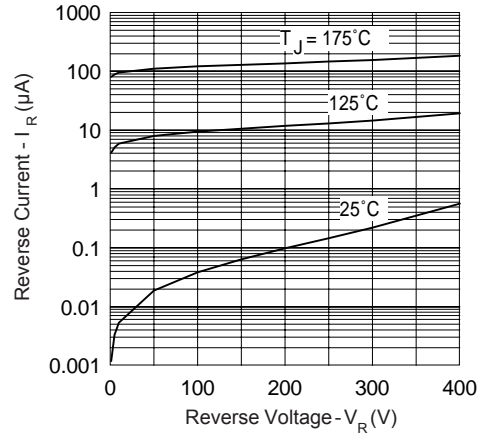

Fig. 2 - Typical Values Of Reverse Current Vs. Reverse Voltage

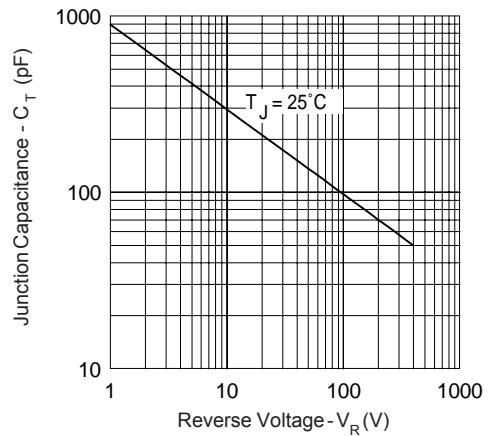

Fig. 3 - Typical Junction Capacitance Vs. Reverse Voltage

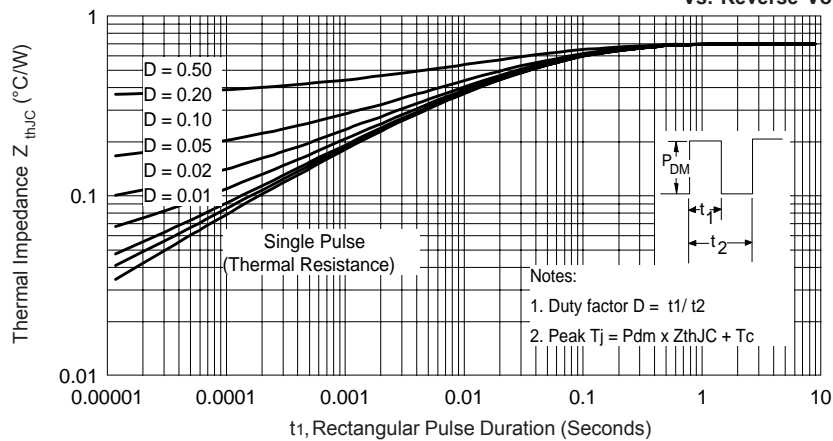

Fig. 4 - Max. Thermal Impedance Z_{thJC} Characteristics

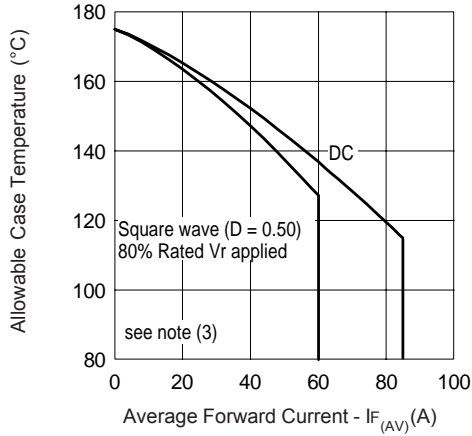

Fig. 5 - Max. Allowable Case Temperature Vs. Average Forward Current

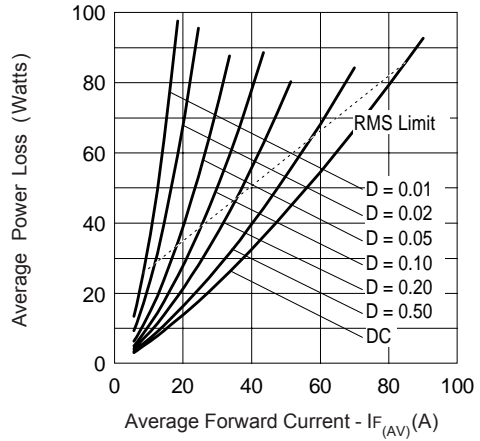

Fig. 6 - Forward Power Loss Characteristics

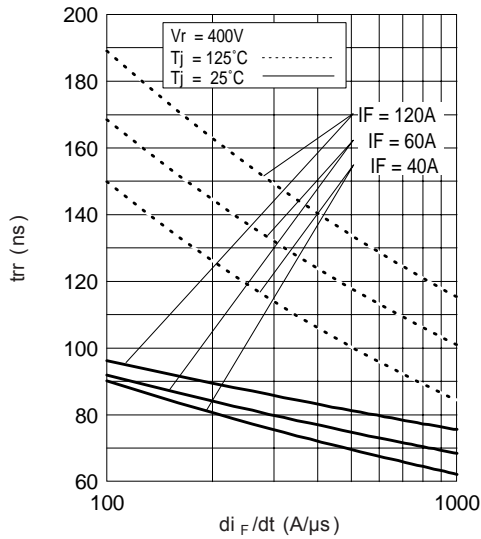

Fig. 7 - Typical Reverse Recovery time vs. di_F/dt

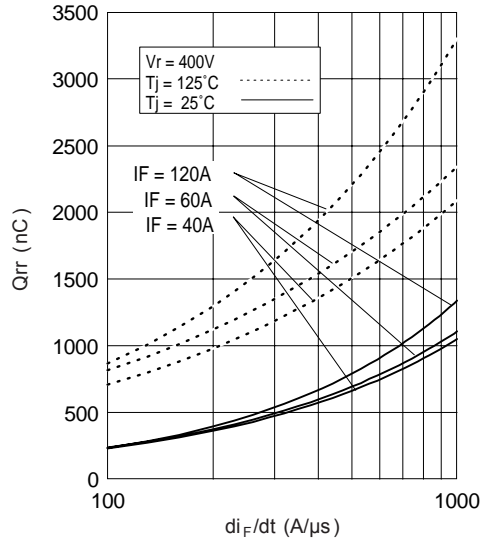

Fig. 8 - Typical Stored Charge vs. di_F/dt

(3) Formula used: $T_c = T_j - (P_d + P_{d_{REV}}) \times R_{thJC}$;

P_d = Forward Power Loss = $I_{F(AV)} \times V_{FM} @ (I_{F(AV)} / D)$ (see Fig. 6);

$P_{d_{REV}}$ = Inverse Power Loss = $V_{R1} \times I_R (1 - D)$; $I_R @ V_{R1} = 80\%$ rated V_R

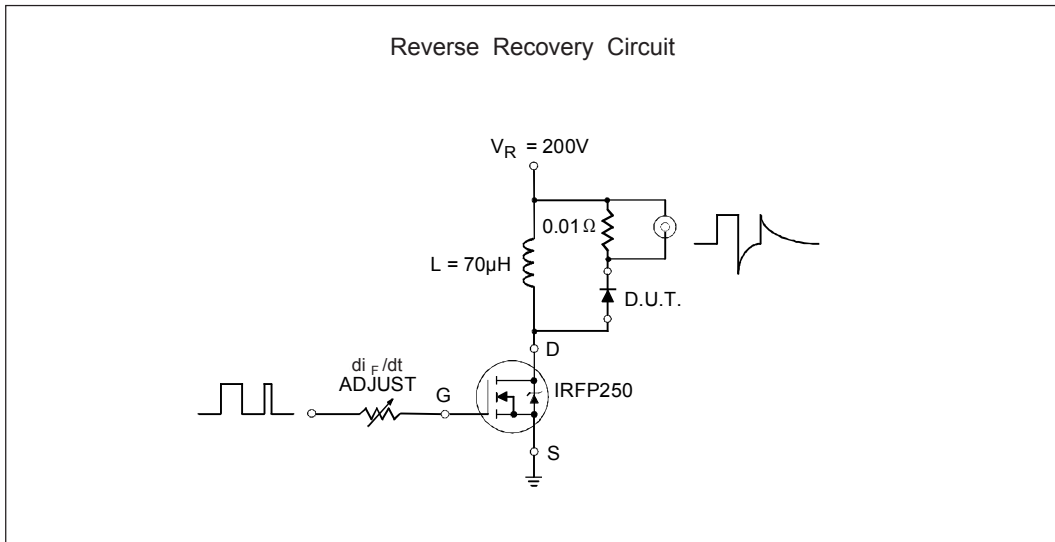

Fig. 9- Reverse Recovery Parameter Test Circuit

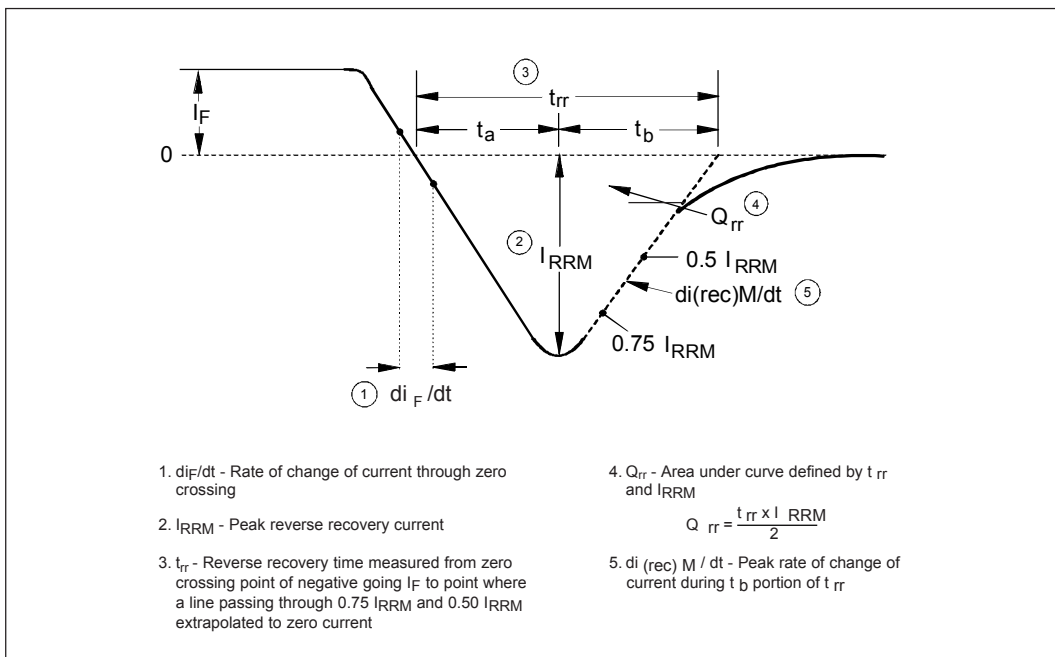
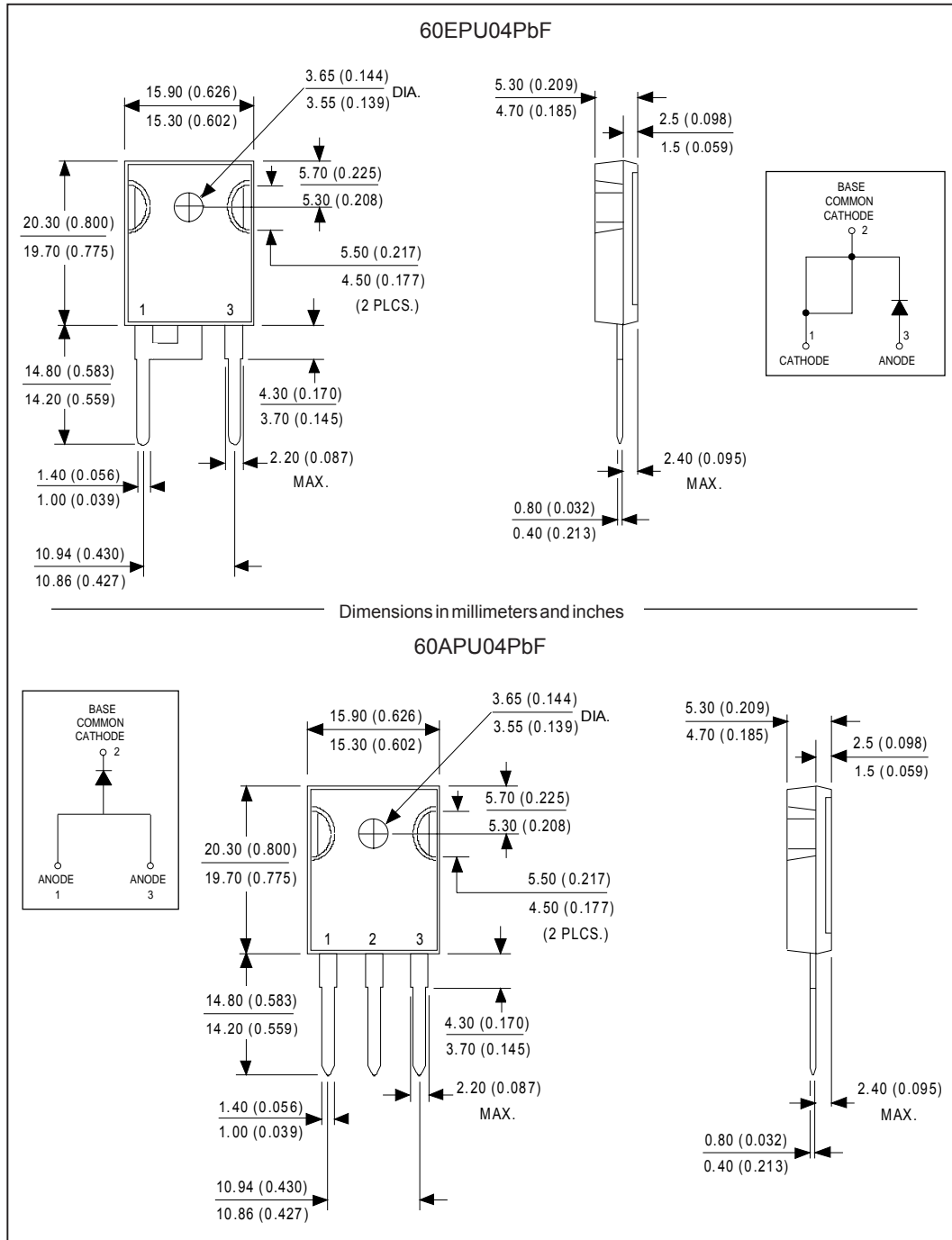

Fig. 10 - Reverse Recovery Waveform and Definitions

Outline Table



Marking Information

EXAMPLE: THIS IS A 60EPU04
 WITH ASSEMBLY
 LOT CODE 5657
 ASSEMBLED ON WW 35, 2000
 IN ASSEMBLY LINE "H"

INTERNATIONAL
RECTIFIER
LOGO

ASSEMBLY
LOT CODE

PART NUMBER

DATE CODE
 P = LEAD-FREE
 YEAR 0 = 2000
 WEEK 35
 LINE H

EXAMPLE: THIS IS A 60APU04
 WITH ASSEMBLY
 LOT CODE 5657
 ASSEMBLED ON WW 35, 2000
 IN ASSEMBLY LINE "H"

INTERNATIONAL
RECTIFIER
LOGO

ASSEMBLY
LOT CODE

PART NUMBER

DATE CODE
 P = LEAD-FREE
 YEAR 0 = 2000
 WEEK 35
 LINE H

Ordering Information Table

Device Code	60	E	P	U	04	PbF
	①	②	③	④	⑤	⑥
1	- Current Rating (60 = 60A)					
2	- Circuit Configuration: E = Single Diode A = Single Diode, 3 pins					
3	- Package: P = TO-247AC (Modified)					
4	- Type of Silicon: U = UltraFast Recovery					
5	- Voltage Rating (04 = 400V)					
6	- • none = Standard Production • PbF = Lead-Free					

60EPU04PbF, 60APU04PbF

Bulletin PD-21080 08/05

International
IOR Rectifier

Data and specifications subject to change without notice.
This product has been designed and qualified for Industrial Level and Lead-Free.
Qualification Standards can be found on IR's Web site.

International
IOR Rectifier

IR WORLD HEADQUARTERS: 233 Kansas St., El Segundo, California 90245, USA Tel: (310) 252-7105
TAC Fax: (310) 252-7309
Visit us at www.irf.com for sales contact information. 08/05