



Ferrites and accessories

Application notes

Date: September 2006

1 Cores for filter applications

1.1 Gapped cores for filter/resonant circuits

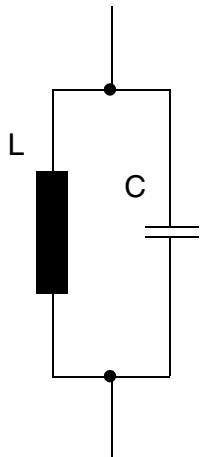

Basic requirements:

- Low $\tan \delta$
- Close tolerance for A_L value
- Close tolerance for temperature coefficient
- Low disaccommodation factor DF
- Wide adjustment range

Gapped cores are therefore always used in high quality circuits (see "SIFERRIT materials, 1 Application survey").

In the case of small air gaps (max. 0.2 mm) the air gap can be ground into only one core half. In this case the half with the ground air gap bears the stamp. The other half is blank.

The air gap enables the losses in the small-signal area and the temperature coefficient to be reduced by a factor of μ_e/μ_i in the small-signal area. More important, however, is that close A_L value tolerances can be achieved.

The rated A_L values for cores with ground air gap can be obtained from the individual data sheets. The data for the individual cores also include the effective permeability μ_e used to approximately determine the effective loss factor $\tan \delta_e$ and the temperature coefficient of the effective permeability α_e from the ring core characteristics (see table of material properties).

It should be noted at this point that in cores with a larger air gap the stray field in the immediate vicinity of the air gap can cause additional eddy current losses in the copper winding. If the coil quality must meet stringent requirements, it is therefore advisable to wind several layers of polystyrene, nylon tape or even FPC film under the wire in the part of the winding that is in the proximity of the air gap; with a 3-section coil former this would be the part of the center section near the air gap.

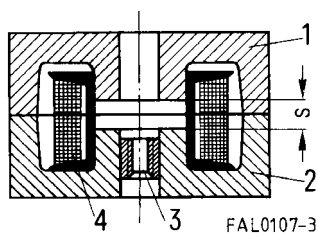

Figure 10

Schematic drawing showing the construction of a P or RM core set with a total air gap s , comprising 2 core halves (1 and 2), threaded part (3) and padded winding (4)

1.2 P and RM cores with threaded sleeves

Most of P and RM cores are supplied with a glued-in threaded sleeve. EPCOS uses automatic machines featuring high reliability in dosing of the adhesive and in positioning the threaded sleeve in the core.

The tight fit of the threaded sleeve is regularly checked – including a humid atmosphere of 40 °C/93% r.h. (to IEC 60068-2-3-78) over 4 days – and also by periodic tests over 3 weeks. The usual bonding strengths of 20 N for Ø 2 mm holes (e.g. for RM 5) and 30 N for Ø 3 mm holes (e.g. for P 14 × 11, RM 6) are greatly exceeded, reaching an average of > 100 N. The threaded sleeve is continuously checked for proper centering. Overall, the controlled automated procedure guarantees higher reliability than manual gluing with its unavoidable inadequacies. Owing to the porosity of the ferrite, tension of the ferrite structure due to hardened adhesive that has penetrated cannot always be avoided. Hence, the relative temperature coefficient α_F may be increased by approximately $0.2 \cdot 10^{-6}/K$.

1.3 Typical calculation of a resonant circuit inductor

The following example serves to illustrate the dependencies to be considered when designing a resonant circuit inductor:

A SIFERRIT pot core inductor is required with an inductance of $L = 640 \mu H$ and a minimum quality factor $Q = 400$ ($\tan \delta_L = 1/Q = 2.5 \cdot 10^{-3}$) for a frequency of 500 kHz. The temperature coefficient α_e of this inductor should be $100 \cdot 10^{-6}/K$ in the temperature range +5 to +55 °C.

a) Choice of material

According to the table of material properties and the $\tan \delta/\mu_i$ curves (see chapter “SIFERRIT materials”) the material M33, for example, can be used for 500 kHz.

b) Choice of A_L value

The Q and temperature coefficient requirements demand a gapped pot core. The relative temperature coefficient α_F of SIFERRIT M33 according to the table of material properties is on average about $1,6 \cdot 10^{-6}/K$. Since the required α_e value of the gapped P core should be about $100 \cdot 10^{-6}/K$, the effective permeability is

$$\alpha_F = \frac{\alpha_e}{\mu_e} \quad \Rightarrow \quad \mu_e = \frac{\alpha_e}{\alpha/\mu_i} = 100 \cdot 10^{-6}/K \cdot \frac{1}{1,6 \cdot 10^{-6}/K} = 62.5$$

With pot core P 18 × 11 (B65651): $\mu_e = 47.9$ for $A_L = 100$ nH.

With pot core P 22 × 13 (B65661): $\mu_e = 39.8$ for $A_L = 100$ nH.

c) Choice of winding material

RF litz wire 20 × 0.05 with single natural silk covering is particularly suitable for frequencies around 500 kHz. The overall diameter of the wire including insulation of 0.367 mm and the average resistivity of 0.444 Ω/m are obtained from the litz-wire table (refer to pertinent standard). It is recommended that the actual overall diameter always be measured, and this value used for the calculation.

d) Number of turns and type of core

For an A_L value of 100 nH and an inductance of 640 μ H the equation $N = (L/A_L)^{1/2}$ yields 80 turns. The nomogram for coil formers (see "Processing notes, P cores") shows that for a wire with an external diameter of 0.367 mm the two-section coil former for core type P 18 \times 11 can easily take 80 turns. This core type can therefore be used with a one-section coil former.

e) Length of wire and DC resistance

The length of an average turn l_N on the above former is 35.6 mm. The length of litz wire necessary for the coil is therefore $80 \cdot 35.6 \text{ mm} = 2848 \text{ mm}$ plus say $2 \cdot 10 \text{ cm}$ for the connections, giving a total length of 3.04 m. The average resistivity of this wire is 0.444 Ω /m; the total DC resistance is thus $3.04 \text{ m} \cdot 0.444 \Omega/\text{m} \approx 1.35 \Omega$. It should be noted that the length of an average turn l_N given in the individual data sheets always refers to the fully wound former. If the former is not fully wound, the length of an average turn must be corrected according to the extent of the winding.

f) Checking the temperature coefficient

The core P 18 \times 11 with $A_L = 100 \text{ nH}$ has an effective permeability $\mu_e = 47.9$. SIFERRIT M33 has a relative temperature coefficient $\alpha_F \approx 1.6 \cdot 10^{-6}/\text{K}$; therefore the following temperature coefficient can be calculated

$$\alpha_e = \mu_e \cdot \alpha_F = 47.9 \cdot 1.6 \cdot 10^{-6}/\text{K} = 76.6 \cdot 10^{-6}/\text{K}$$

Actual measurement yielded $90 \cdot 10^{-6}/\text{K}$.

It should be pointed out that with pot cores the temperature coefficient of the unwound coil has almost no influence since the flux density lies primarily in the core.

For effective permeabilities $\mu_e < 80$, however, due to the influence of the winding an additional temperature coefficient of approx. $(10 \text{ to } 30) \cdot 10^{-6}/\text{K}$ must be included in the calculation.

2 Cores for broadband transformers

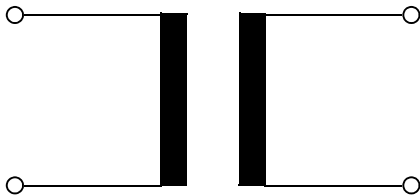

General requirements:

- High A_L values ($\hat{=}$ high effective permeability) to restrict number of turns
- Good broadband properties, i.e. high impedance up to highest possible frequencies
- Low total harmonic distortion ($\hat{=}$ low hysteresis material constant η_B)
- Low sensitivity to superimposed DC currents ($\hat{=}$ highest possible values for T_C and B_S)
- Low $\tan \delta$ for high-frequency applications

2.1 Precision-ground, ungapped cores for broadband transformers

For fields of application such as matching transformers in digital telecommunication networks or pulse signal transformers, either cores which form a closed magnetic circuit (toroids, double E or double-aperture cores) or paired core sets without air gap are used. In order to achieve the highest possible effective permeability here, these cores are precision ground with residual air gaps $s \sim 1 \mu\text{m}$. By selecting the low-profile core types, the A_L value can be further increased, and the number of turns reduced.

For this reason, RM and pot cores made of materials N30, T38, T46 and T66 are especially suitable for these applications. For high-frequency applications, N22, M33 and K1 are suitable.

2.2 Fundamentals for broadband transformers in the range 10 kHz to over 1 GHz – an example

Broadband transformers are constructed primarily using closed core shapes, i.e. toroids and double-aperture cores. Divided core designs such as P/RM cores or small E/ER cores, which allow more simple winding, are particularly suitable for transformers up to approximately 200 MHz.

The bandwidth $\Delta f = f_{oG} - f_{uG}$ (f_{oG} = upper cut-off frequency, f_{uG} = lower cut-off frequency) is considered the most important transformer characteristic.

Cut-off frequency: Frequency at which the voltage at the transformer drops by 3 dB ($\hat{=}$ -30%)

The following holds true for circuit quality $Q > 10$ (typical value):

$$\Delta f = \frac{f_r}{R_i} \cdot \sqrt{\frac{L_H}{C_0}}$$

- f_r Resonance frequency
- R_i Internal resistance of generator (normally, $R_i \ll$ loss resistance of ferrite)
- L_H Main inductance
- C_0 Winding capacitance

Transmission loss curve:

$$\alpha = \ln \frac{U}{U_r}$$

U_r Voltage at f_r

α Attenuation when matched with line impedance (e.g. 50Ω)

Example: 1 : 1 transformer based on E6.3/T38 with 2×10 turns

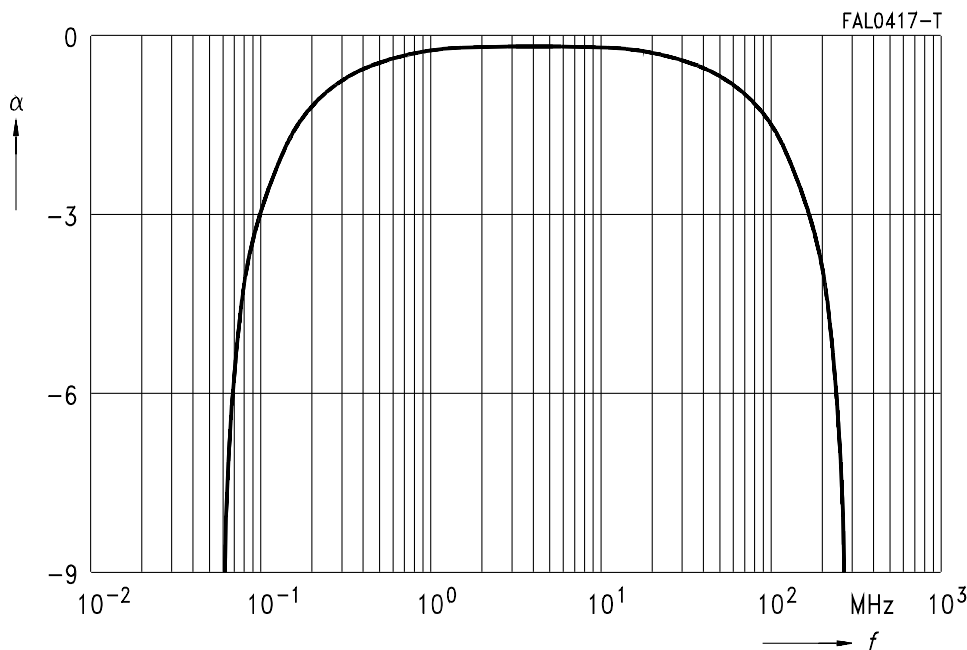

Figure 11

Transmission loss curve for transformer E6.3/T38 with 2×10 turns (parallel)

2.3 Low-distortion transformers for digital data transmission (ISDN, xDSL)

The digital transmission technologies over copper like ISDN, HDSL (high-rate digital subscriber line) and ADSL (asymmetric digital subscriber line) require very small harmonic distortion in order to maintain maximal line length. This requirement can be calculated from material parameters for the third harmonic distortion with the Rayleigh model for small-signal hysteresis (sinusoidal current).

$$k_3 = \frac{u_3}{u_1} = 0.6 \cdot \tan \delta_h = 0.6 \cdot \mu_e \cdot \eta_B \cdot \hat{B}$$

For a typical design a transformer has to be matched to a chipset via the turn ratios $N_1 : N_2 : N_3 \dots$, the inductances $L_1, L_2, L_3 \dots$ and the maximum DC resistances $R_1, R_2, R_3 \dots$

Application notes

Broadband transformers

The third harmonic distortion for winding j can then be calculated as

$$k_3 = \frac{0.6}{\mu_0} \cdot \underbrace{\eta_B}_{\text{Material}} \cdot \underbrace{\frac{\hat{U}}{2\pi f}}_{\text{Circuit conditions}} \cdot L_j \cdot \underbrace{\left[\frac{\rho}{f_{Cu}} \sum_{j=1}^n \left(\frac{N_j}{N_1} \right)^2 \cdot \frac{1}{R_j} \right]^{3/2}}_{\text{Design constraints}} \cdot \underbrace{\frac{\sum I_i}{I_e} \cdot \frac{I_e}{A_e^2}}_{\text{Core Geometry}} \cdot \underbrace{\frac{I_N^{3/2}}{A_N^{3/2}}}_{\text{Coil former Geometry}}$$

This equation shows the contribution of the various design parameters:

- The material is characterized by the hysteresis material constant η_B . Limit values for this parameter are given in the SIFERRIT material tables. The actual level for η_B varies for different cores. In order to select the best material for an application, the normalized temperature dependence $\eta_B(T)/\eta_B(25^\circ\text{C})$ is of great help (cf. graph in chapter "SIFERRIT materials"). Being mainly composition-dependent, these curves are thus material-specific.
- The geometry can be taken into account by a core distortion factor (CDF) defined as

$$\text{CDF} = \frac{\sum I_i}{I_e} \cdot \frac{I_e}{A_e^2} \cdot \frac{I_N^{3/2}}{A_N^{3/2}}$$

The factor $\sum I_i/I_e$ is the closer to 1, the less the core section varies along the magnetic path (homogeneous core shape). The values for CDF are given in the following table for the core shapes preferred for these applications.

Cores w/o hole	CDF (mm ^{-4.5})	Cores w. hole	CDF (mm ^{-4.5})	EP cores	CDF (mm ^{-4.5})
P 9 × 5	1.25	P 3.3 × 2.6	85.9	EP 5	10.6
P 11 × 7	0.644	P 4.6 × 4.1	46.7	EP 6	9.99
P 14 × 8	0.164	P 7 × 4	4.21	EP 7	1.68
P 18 × 11	0.0470	P 9 × 5	1.72	EPX 7/9	0.749
P 22 × 13	0.0171	P 11 × 7	0.790	EPX 9/9	0.457
P 26 × 16	0.00723	P 14 × 8	0.217	EP 10	0.506
P 30 × 19	0.00311	P 18 × 11	0.0545	EPX 10	0.329
P 36 × 22	0.00149	P 22 × 13	0.0220	EP 13	0.191
RM 4	0.498	P 26 × 16	0.0099	EPO 13	0.172
RM 5	0.184	P 30 × 19	0.00366	EP 17	0.0619
RM 6	0.0576	P 36 × 22	0.00166	EP 20	0.00945
RM 7	0.0339	P 41 × 25	0.00112	EFD 10	3.919
RM 8	0.0162	RM 4	0.814	EFD 15	0.376
RM 10	0.00676	RM 5	0.243	EFD 20	0.0837
RM 12	0.00215	RM 6	0.0779	EFD 25	0.0231
RM 14	0.00100	RM 7	0.0415	EFD 30	0.0161
		RM 8	0.0235	ER 9.5	2.557
		RM 10	0.00906	ER 11	1.453

Application notes

Broadband transformers

The values of this parameter indicate that roughly

$$\text{CDF} \sim \frac{1}{V_e^{3/2}}$$

i.e. the larger the core, the smaller is the distortion. Due to space restriction, however, the choice has to be made among the core shapes of a given size.

- The circuit conditions, i.e. voltage amplitude \hat{u} and frequency f affect directly the flux density in the core. For increasing flux density, a deviation of the absolute value of k_3 from the calculated test value is expected, since the $\tan \delta_h$ vs. \hat{B} curve deviates from linear.
- The distortion k_{3c} for a transformer in a circuit with given impedance conditions can be obtained from the following formula:

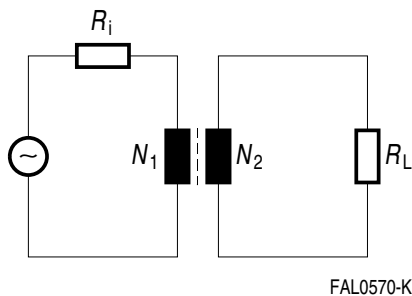

FAL0570-K

Figure 12

Equivalent circuit diagram for a broadband transformer

$$k_{3c} = \frac{k_3}{\sqrt{1 + \left[3\omega L_1 \cdot \left(\frac{1}{R_i} + \left(\frac{N_2}{N_1} \right)^2 \cdot \frac{1}{R_L} \right) \right]^2}}$$

- R_i Internal resistance of generator
- R_L Load resistance
- L_1 Primary inductance

The actual circuit distortion k_{3c} will in general be smaller than the calculated sinusoidal current value k_3 .

3 Cores for LAN applications

LAN (Local Area Network) is a connection of local computers in most cases inside a building. The transfer rate values between 10 Mbit/s and 100 Mbit/s. The transmission rates are 10 Mbit/s (10 Base T), 100 Mbit/s (100 Base T) and 1 Gbit/s (Gigabit Ethernet).

3.1 Signal transformers

To design the signal 1:1 transformer small toroids are typically used. Its functions are impedance matching and network termination. Due to space restriction the core has to be the smallest possible, that still meets the inductance requirement under the given working conditions (100 kHz).

The mostly used core sizes are beginning from outer/inner diameters of 2.54/1.27 mm (0.1/0.05 inch) up to 3.94/2.24 mm (0.155/0.088 inch) with different variations of inner diameter and core height (refer also to chapter "Toroids").

The multi-level coding of the digital waveform is not always symmetrical to the zero line. This imbalance results in an effective DC current, which is allowed to value 8 mA max. Therefore the inductance of the ferrite toroid is specified under a constant DC current of 8 mA. The saturation flux density values 430 mT at 25 °C and the initial permeability is 4000 (figure 13).

For indoor application the temperature range is 0 to 70 °C. To use the LAN technology also in outdoor application the temperature range needs to be extended from -40 to +85 °C without changing the electrical specification.

The material T57 enables design in both temperature ranges.

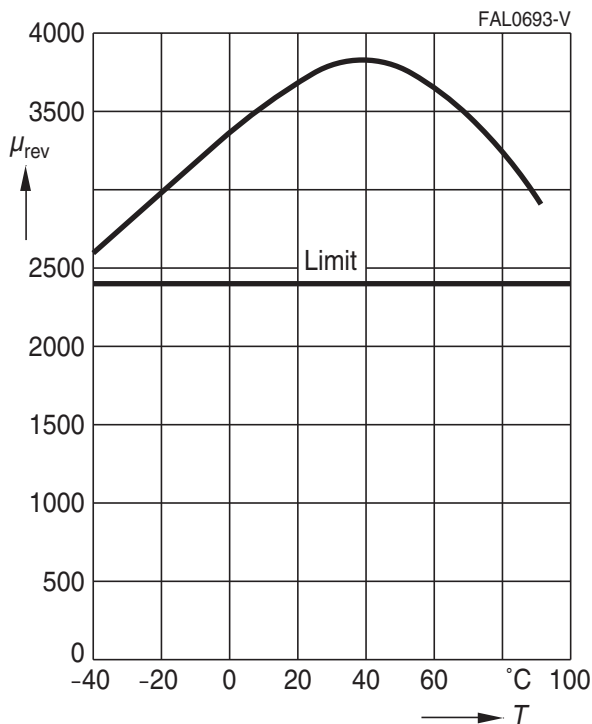

Figure 13

μ_{rev} versus temperature, measured on toroid R 3.43/1.78/2.11; material T57 $f = 100$ kHz, $\hat{B} = 6$ mT, $N = 26$, $H_{DC} = 27$ A/m. ($I_{DC} = 8$ mA)

3.2 Common-mode chokes

For the suppression of common-mode interference in the frequency range from about 30 MHz to 300 MHz it is necessary to use current-compensated chokes in the LAN network.

The corresponding ferrite material is K10, which is a NiZn material with a permeability of approx. 700 for small Parylene coated cores. The impedance versus frequency curve of K10 is ideally adapted to the suppression requirement in the LAN network (figure 14).

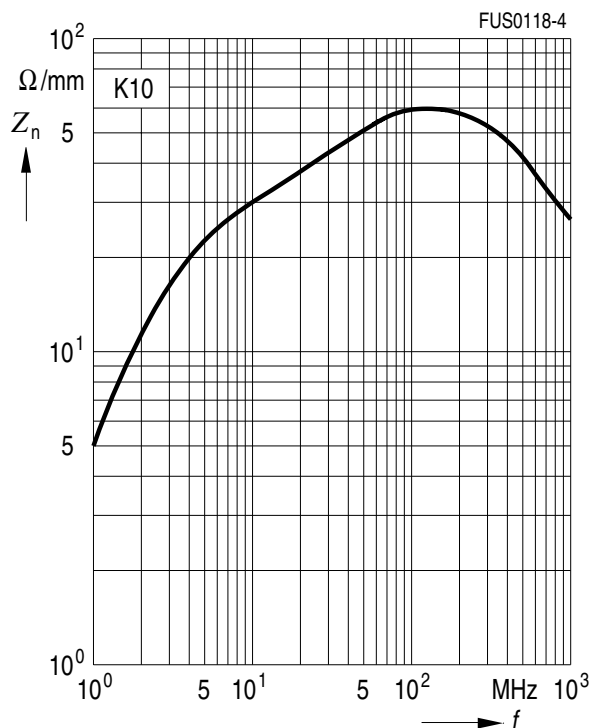

Figure 14

Normalized impedance curve, measured on toroid R 10 (N = 2 turns)

3.3 Coating to ensure highest insulation resistance

Typically the toroid has to withstand 1 kV Hipot test. Therefore the toroids needs to be coated with Parylene which ensures highest insulation resistance. With 12.5 μm (0.0005 inch) a breakdown voltage of 2.7 kV can be achieved. The coating will also protect the wire during winding operation. The material data sheet specifies a breakdown voltage of 2.7 kV, if coated 12.5 μm .

4 Cores for EMI applications

4.1 Ring cores to suppress line interference

With the ever-increasing use of electrical and electronic equipment, it becomes increasingly important to be able to ensure that all facilities will operate simultaneously in the context of electromagnetic compatibility (EMC) without interfering with each others' respective functions. The EMC legislation which came into force at the beginning of 1996 applies to all electrical and electronic products marketed in the EU, both new and existing ones. So the latter may have to be modified so that they are neither susceptible to electromagnetic interference, nor emit spurious radiation. Ferrite cores are ideally suited for this purpose since they are able to suppress interference over a wide frequency range.

At frequencies above 1 MHz, ferrite rings slipped over a conductor lead to an increase in the impedance of this conductor. The real component of this impedance absorbs the interference energy.

A ferrite material's suitability for suppressing interference within a specific frequency spectrum depends on its magnetic properties, which vary with frequency. Before the right material can be selected, the impedance $|Z|$ must be known as a function of frequency.

The curve of impedance as a function of frequency is characterized by the sharp increase in loss at resonance frequency.

Measurement results:

The measurements shown here were made at room temperature (25 ± 3) °C using an HP 4191A RF impedance analyzer with a flux density of $\hat{B} \leq 1$ mT.

The maximum of the impedance curve shifts to lower frequencies as the number of turns increases; this is due to the capacitive effect of the turns (figure 15, using R 25/15 as an example).

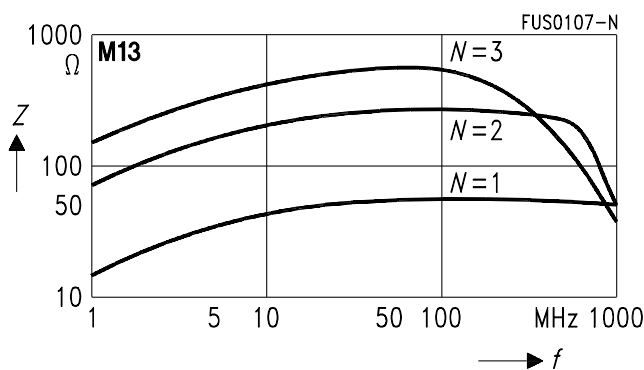

Figure 15

Impedance characteristic curve

The impedance curves of different materials are summarized in chapter "SIFERRIT materials" for direct comparison. The normalized impedance $|Z|_n = |Z| / N^2 \times \Sigma (l_e / A_e)$ were used to display material properties only. The geometry factor was calculated on the basis of the core dimensions.

These normalized impedance curves are guide values, mostly measured using toroidal core R 10 with a number of turns $N = 1$ (wire diameter 0.7 mm); they may vary slightly, depending on the geometry.

4.2 Common-mode chokes

Compact electrical and electronic equipment primarily generates common-mode interference. In order to be able to meet the safety requirements (keeping within the leakage current limits), chokes with a high asymmetrically effective inductance must be used. Current-compensated chokes with a closed core topology are especially suitable for this purpose. The problem of core material saturation due to the useful current is solved in these designs by winding two coils with equal number of turns on the core. These coils are connected in such a way that the magnetic flux induced by the upper coil is compensated by the lower coil.

The new Magnetic Design Tool of EPCOS contains the normalized impedance versus frequency curves of all ferrite materials, which are suitable for EMI applications.

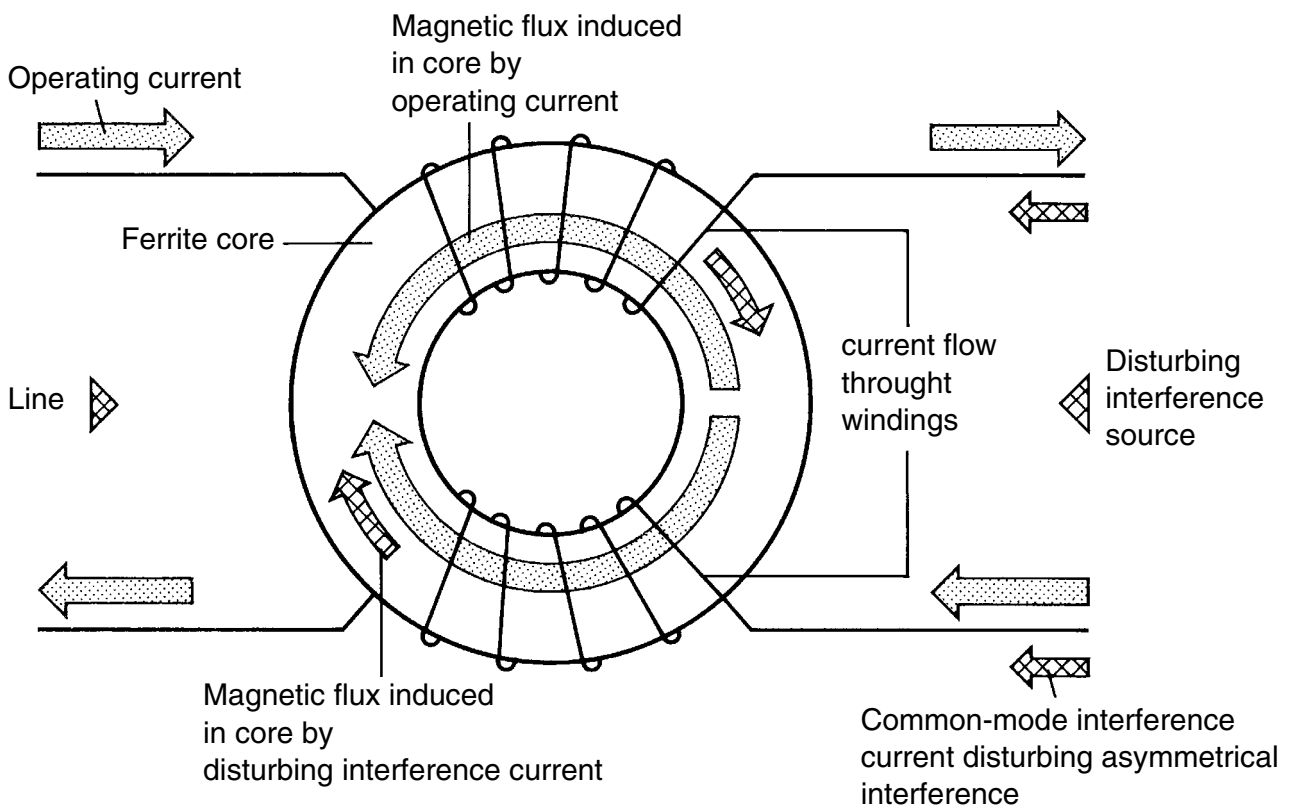

SSB0554-A

Figure 16

Current-compensated toroid choke; double choke shown as an example

4.3 NiZn ferrites

Toroidal cores of NiZn ferrites are especially suitable for the suppression of high frequency interference, because of the high ohmic resistance of these materials (ca. $10^5 \Omega\text{m}$). Therefore the negative effect of eddy current is negligible and the usage of these materials allow relatively high impedance values even at frequency well above 100 MHz. There is limiting factor to create NiZn ferrites with higher initial permeability, because with increasing permeability the Curie temperature decreases. For example the Curie temperature for a NiZn ferrite of $\mu_i = 2300$ (M13) is specified $>105^\circ\text{C}$, which is at the limit for many applications.

Application notes

EMI applications

An application example in the automotive sector is the CAN bus choke, where core sizes from outer diameter 2.5 mm to 6.3 mm (0.1 to 0.29 inch) in material K7, K8 and K10 are used. As the transmission frequencies in the telecom industry are rising, it is also expected, that the demand for NiZn ferrites will grow.

Another application example for NiZn ferrite toroids is the usage of cores alone on component leads or in board level circuitry either

- to prevent any parasitic oscillations or
- to attenuate unwanted signal pickup or transmissions which might travel along component leads or interconnecting wires, traces, or cables.

4.4 MnZn ferrites

For the application as current-compensated chokes MnZn ferrites are widely used in the whole range of sizes. The advantage of the MnZn materials is the much higher permeability, which can be realised together with a sufficiently high Curie temperature. Using very high permeability ferrites reduces the number of turns, which are necessary to reach a certain inductance. This avoids the negative impact of a high number of turns like DC resistance or parasitic capacitance and not at least costs.

Small cores R 2.5 up to R 12.5 in the materials N30, T38, T46 can be used for example in Telecom networks like ISDN.

Cores of mid range sizes from R 13.3 to R 26 are used as choke in power lines usually in electronic ballasts in lamps, switch-mode power supplies in TV sets, washing machines and chargers. Ferrite materials: N30, T65, T35, T37, T38 and T46.

The usage for core sizes R 34 and bigger are in industrial applications, in filters for frequency converters (lifts, pumps, traction systems, conveyer systems, air conditioning systems), general-purpose application in power electronics, UPS and wind-driven power plants. Especially for high temperature or/and high current application in these fields our material T65 is the most suitable because of its high saturation flux density of 460 mT and high Curie temperature of >160 °C. The initial permeability on big cores is about 4500 to 5000.

If there is not especially high current or high temperature applied, we recommend to use our materials N30 ($\mu_i = 4300$) and T37 (μ_i approx. 5500 to 6000 on big cores). The choice of material depends on the frequency range, which has to be covered by the attenuation. This is determined by the characteristic of permeability.

5 Cores for inductive sensors

The proximity switch, widely used in automation engineering, is based on the damping of a high-frequency LC oscillator by the approach of a metal. The oscillator inductor consists of a cylindrical coil and a ferrite core half whose open side forms what is known as the active area. The function of the ferrite core consists in spatially aligning the magnetic field so as to restrict the interaction area.

The oscillator design must take into account that the inductor forms a magnetically open circuit. The inductance and quality are decisively dependent on the coil design, unlike in the case of closed circuits. The initial permeability plays a subordinate role here, as is shown by the following example:

Core: P 9 × 5 (B65517D*)
 Coil: 100 turns, 0.08 CuL
 Current: 1 mA
 Frequency: 100 kHz

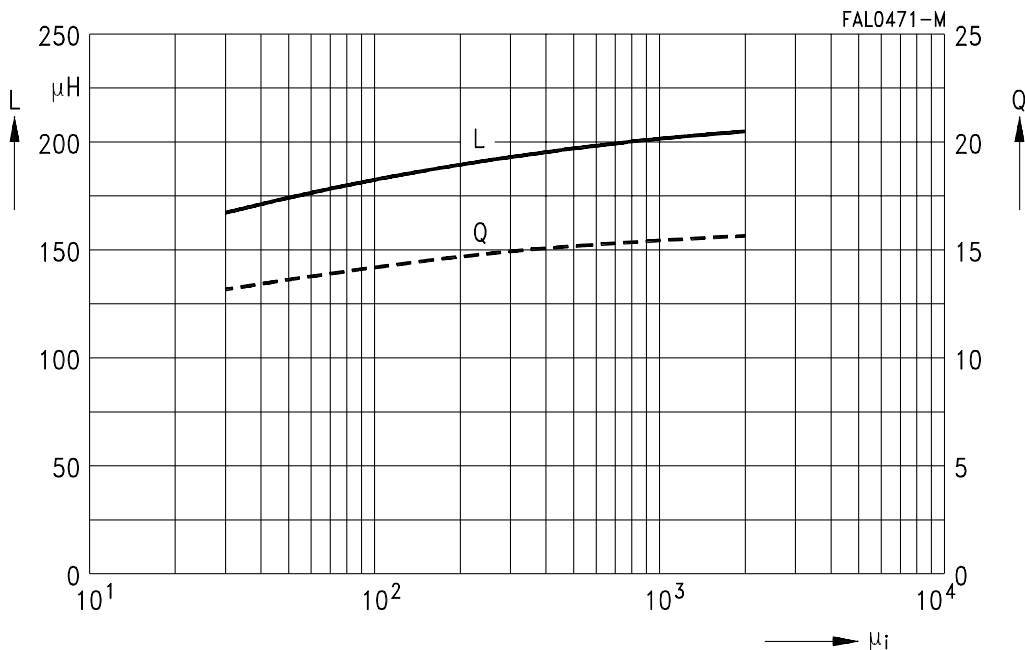

Figure 17

Inductance and quality versus initial permeability

P 9.3 × 2.7, N = 100, f = 100 kHz, I = 1 mA

Decisive for this application is the attainment of as high a Q as possible, with the lowest possible dependence on temperature at the oscillator frequency. When the distance between the damping lug and the active area changes, the oscillator Q should however change as strongly as possible.

If the relative change in Q $\Delta Q/Q$ exceeds a predefined threshold, e.g. 10%, a switching operation is initiated at the so-called operating distance. Attainment of the target values depends on appropriate coil dimensioning and can generally only be performed empirically.

6 Cores for power applications

6.1 Core shapes and materials

The enormously increased diversity of application in power electronics has led to a considerable expansion not only in the spectrum of core shapes but also in the range of materials.

To satisfy the demands of higher-frequency applications, the EFD cores have been developed in sizes EFD 10, 15, 20, 25 and EFD 30. These are characterized by an extremely flat design, optimized cross-sectional distribution and optimized winding shielding.

For many standard applications up to 100 kHz, materials N27, N41 and N72 can be used. For the range up to 500 kHz, materials N92, N87 and N97 are suitable. N49 covers the range from 300 kHz to 1 MHz e.g. for DC/DC (resonance) converters.

For detailed information on core shapes see the individual data sheets, for general information on materials see the chapter on SIFERRIT materials.

6.2 Low-profile cores for planar magnetics

The design of planar devices has attracted the attention of magnetic design engineers, since this type of devices has interesting advantages over conventional wound components (cf. figure 18):

- Low total height
- Outstanding reproducibility of electrical parameters
- Excellent thermal performance
- High degree of integration

a) Conventional magnetics

b) Planar magnetics

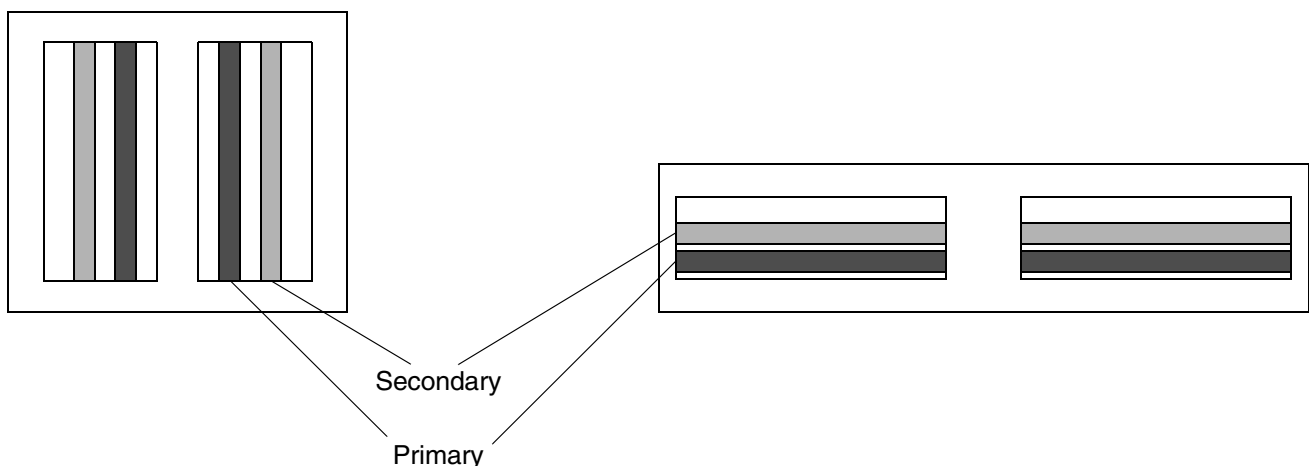

Figure 18

Principle of conventional and planar magnetics

In order to fulfill the requirements of this technology, suitable cores are needed. The most common designs of low-profile cores have been adopted in the IEC standards IEC 62317-4 for RM LP cores and IEC 62317-9 for ELP, EQ and ER planar cores to offer geometrically compatible cores for this application. A common denominator of these cores is that the length of the core is larger than both its total height and its width.

Application notes

Power applications

The advantages of this core design are:

- High A_L values
- High core surface to volume ratio
- Large core surface to contact heat sink

The preferred materials used in combination with low-profile cores are N87, N97, N92 and N49 for power applications as well as T38 and T46 for applications requiring high inductance values.

6.3 Correlation: Applications – core shape/material

6.3.1 Step-down converters

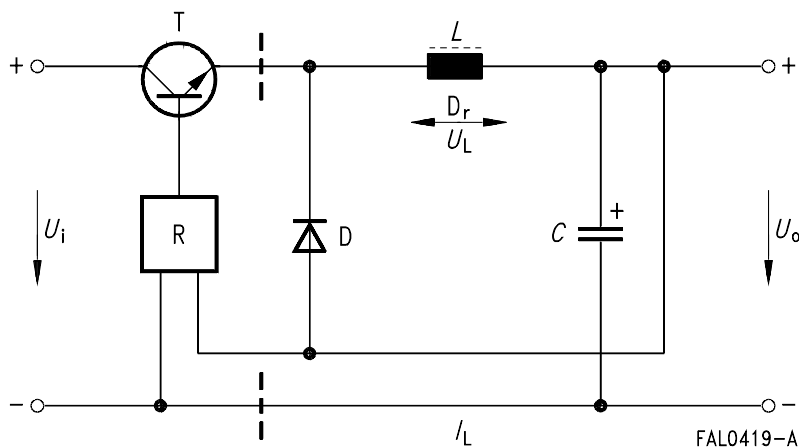

Figure 19 Typical circuit diagram

Advantages

- Only one choke required
- High efficiency
- Low radio interference

Disadvantages

- Only one output voltage
- Restricted short-circuit withstand capability (no line isolation)

Application areas

- Providing a constant output voltage, isolated from input voltage
- Regulation in a forward converter
- Regulated voltage inversion
- Sinusoidal line current draw

Core/material requirements

- Standard requirements regarding losses and saturation

EPCOS recommendations for core shape/material

- E/ETD/U/RM cores made of
 - N27 (standard)
 - N87, N97 (low losses, high saturation)
 - N92 (very high saturation)

6.3.2 Single-ended flyback converter

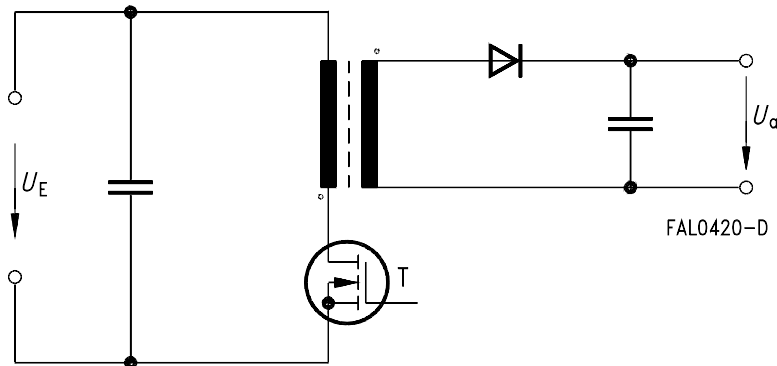

Figure 20 Typical circuit diagram

Advantages

- Simple circuit variant (low cost)
- Low component requirement
- Only one inductive component
- Low leakage losses
- Several easily regulatable output voltages

Disadvantages

- Close coupling of primary and secondary sides
- High eddy current losses in the air gap area
- Large transformer core with air gap restricts possible applications
- Average radio interference
- Exacting requirements on the components

Application areas

- Low and medium powers up to max. 200 W with wide output voltage range
- Maximum operating frequency approx. 100 kHz

Core/material requirements

- Low power losses at high temperature
- Very high saturation with low dependence on temperature
- Gapped cores (recently also with A_L value guarantee)

EPCOS recommendations for core shape/material

- E/U cores in
 - N27 (standard)
 - N87, N92 (low losses, high saturation)

6.3.3 Single-ended forward converter

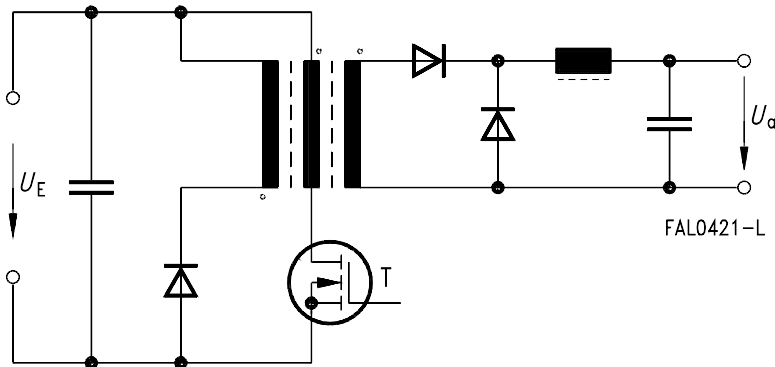

Figure 21 Typical circuit diagram

Advantages

- Higher power range than flyback converter
- Lower demands on circuit components
- High efficiency

Disadvantages

- 2 inductive components
- Large choke
- Demagnetization winding
- High radio interference suppression complexity
- Increased component requirement, particularly with several regulated output voltages

Application areas

- Medium and high powers (up to 500 W) especially in the area of low output voltages
- PWM (pulse width) modulation up to approx. 500 kHz

Core/material requirements

- Low losses at high temperatures and at high frequencies (low eddy-current losses)
- Generally, ungapped cores

EPCOS recommendations for core shape/material

- E/ETD, small EFD cores, RM/PM cores made of
 - N27, N41 (up to 100 kHz)
 - N87, N97 (up to 500 kHz)
 - N49 (up to 1 MHz)

6.3.4 Push-pull converter

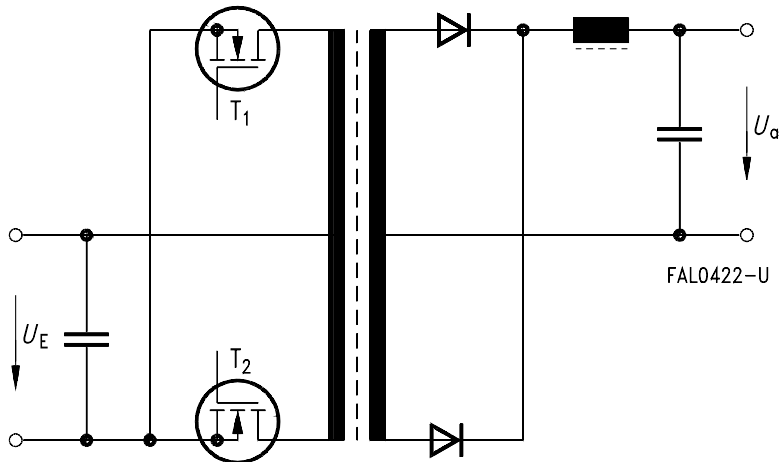

Figure 22 Typical circuit diagram

Advantages

- Powers up to the kW range
- Small choke
- High efficiency
- Low radio interference suppression complexity

Disadvantages

- 2 inductive components
- Complex winding
- High component requirement, particularly with several regulated output voltages

Application areas

- High powers ($\gg 100$ W), also at high output voltages
- PWM (pulse width) modulation up to 500 kHz

Core/material requirements

- Low losses at high temperatures
- Low eddy-current losses since application areas is up to 500 kHz and above
- Generally, ungapped cores

EPCOS recommendations for core shape/material

- Large E/ETD, RM/PM cores made of N27, N97, N87 (with large core cross sections ($A_e \geq 250$ mm²), on account of eddy-current losses N87 must be used even where $f < 100$ kHz)

6.3.5 Electronic lamp ballast device

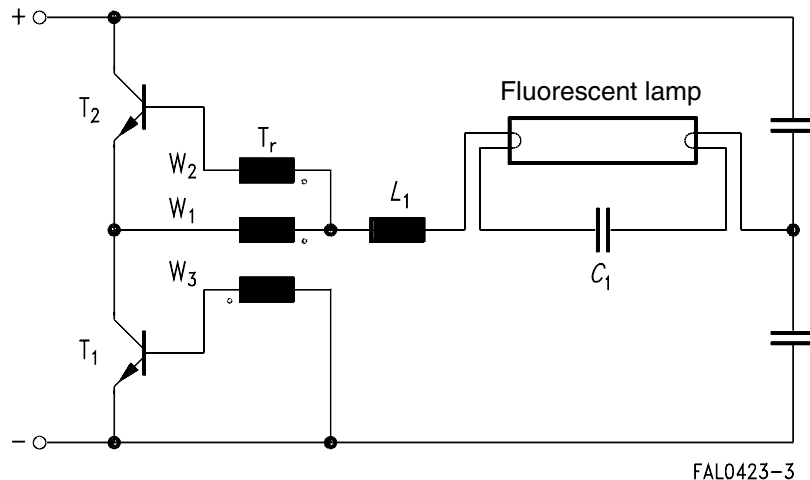

Figure 23 Typical circuit diagram

Advantages

- Considerably reduced size compared to 50 Hz line solution
- Significantly higher efficiency than line voltage regulator

Disadvantages

- High component requirement

Application areas

- Control unit for fluorescent lamps

Core/material requirements

- Low losses in the range 50 to 80 °C
- Pulse power requirements
- Gapped and ungapped E cores
- Ring cores with defined pulse characteristic

EPCOS recommendations for core shape/material

- E/ETD/EFD cores made of N72 for L₁

6.4 Selection of switch-mode power supply transformer cores

The previous section (Correlation: Applications – core shape/material) provides a guide for the rough selection of core shape and material.

The following procedure should be followed when selecting the actual core size and material:

- 1) Definition of requirements
 - Range of power capacities P_{trans}
 - Specification of the SMPS type
 - Specification of pulse frequency and maximum temperature rise
 - Specification of the maximum volume
- 2) Selection of “possible” core shapes/materials on the basis of the “Power capacity” tables starting on page 24.

These tables associate core shape/material combinations (and the volume V) with the power capacity of the different converter types at a “typical” frequency f_{typ} and a “cut-off frequency” f_{cutoff} . The typical frequency specified here is a frequency for which specific applications are known, or which serves as the base frequency for the specified core loss values.

The cut-off frequency is selected such that the advantages of other materials predominate above this frequency and that it is therefore advisable to switch to a different material which is better optimized for this range.

- 3) Final selection of core shape/material

The core shapes/materials selected as possibilities under 2) must now be compared with the relevant data sheets for the specific core types and the material data (typical curves), taking the following points into consideration:

- Volume
- Accessories (power coil former)
- A_L values of ungapped core
- A_L values/air gap specifications
- Temperature minimum for losses, Curie temperature T_C , saturation magnetization B_S , magnetic bias characteristic, amplitude permeability characteristic

Core shape/material combinations which are not contained in the individual data sheets can be requested from EPCOS.

6.5 Selection tables: Power capacities

In order to calculate the transmissible power, the following relationship is used (transformer with two equal windings):

$$P_{trans} = C \Delta B f A_e \cdot A_N \cdot j$$

where C is a coefficient characterizing the converter topology¹⁾, i.e.

- $C = 1$: push-pull converter
- $C = 0.71$: single-ended converter
- $C = 0.62$: flyback converter

1) G. Roespel, “Effect of the magnetic material on the shape and dimensions of transformers and chokes in switched-mode power supplies”, *J. of Magn. and Magn. Materials* 9 (1978) 145-49

Application notes

Power applications

Both the core losses associated with the flux swing ΔB and the copper losses due to the current density j result in a temperature increase ΔT . Assuming that both loss contributions are equal and that $P_V \sim B^2$, the power capacity can be approximated by

$$P_{\text{trans}} \approx C \cdot \underbrace{\frac{PF}{\sqrt{P_V}}}_{\text{Material}} \cdot \underbrace{\frac{\Delta T}{R_{\text{th}}}}_{\text{Thermal design}} \cdot \underbrace{\sqrt{\frac{f_{\text{Cu}}}{\rho_{\text{Cu}}}}}_{\text{Winding}} \cdot \underbrace{\sqrt{\frac{A_N \cdot A_e}{I_N \cdot I_e}}}_{\text{Geometry}}$$

The equation shows how the different aspects in the design contribute to the power capacity:

- The material term is the performance factor PF divided by the square root of the specific core loss level for which it was derived (cf. "SIFERRIT materials" and "General - Definitions, 5.2"). For a given core shape deviations from this value are possible as given by its data sheet.
- The values for ΔT are associated with the material according to the following table.

	ΔT K
N27	30
N41	30
N49	20
N51	10
N72	40
N87	50
N92	50
N95	50
N97	50

- The thermal resistance is defined as

$$R_{\text{th}} = \frac{\Delta T}{P_{V_{\text{core}}} + P_{V_{\text{copper}}}}$$

- These values should be regarded as typical for a given core shape. They were determined by measurement under the condition of free convection in air and are given in the table on page 29 ff.
For actual designs the actual values for R_{th} should be determined and the tabulated P_{trans} values (cf. page 28 ff) adjusted accordingly.
- The winding design was taken into account in the calculations by $f_{\text{Cu}} = 0.4$ and ρ_{Cu} for DC. In actual design large deviations of the DC resistance due to high frequency effects (skin effect, proximity effect) occur, unless special wire types such as litz wires are used. If the $R_{\text{AC}}/R_{\text{DC}}$ ratio for a given winding is known, this can be used to correct the tabulated power capacities accordingly.

Application notes

Power applications

- The geometry term is related to the core shape and size. However, note that the thermal resistance is also size-dependent via the empirical relation (cf. figure 24):

$$R_{th} \sim \frac{1}{\sqrt{V_e}}$$

The tabulated power capacities provide a means for making a selection among cores, although the absolute values will not be met in practice for the reasons explained before.

In the calculation of power capacities the following conditions were also applied:

- The application area for flyback converters was restricted to $f < 150$ kHz.
- The power specifications for N49 should be read as applicable to DC/DC (quasi) resonance converters (single-ended forward operation).
- The maximum flux densities were defined as follows:
For flyback converters: $\Delta B \leq 200$ mT ($\Delta B \leq 50$ mT for material N49)
For push-pull converters: $\Delta B \leq 400$ mT.

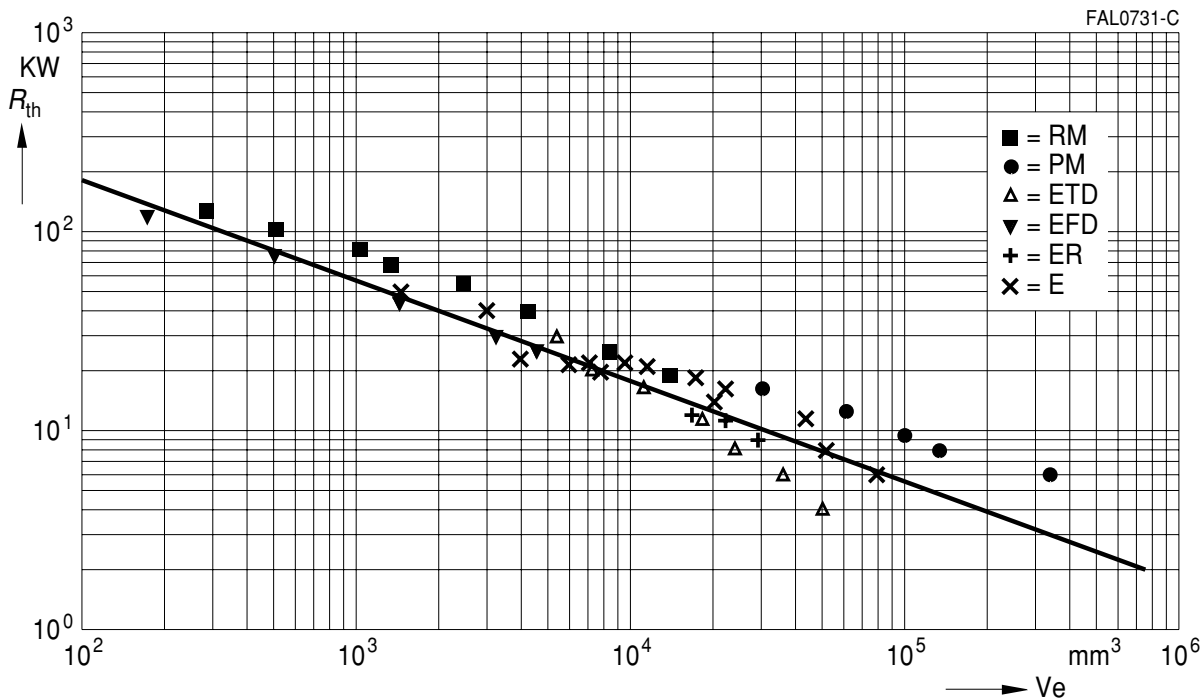

Figure 24

Thermal resistance versus core effective volume

Application notes

Power applications

P_{trans} of cores for wound transformers ($f_{Cu} = 0.4$)

	N27	N41	N49	N72	N87	N92	N97
f_{typ} [kHz]	25	25	500	25	100	100	100
RM 4 LP			19		20	18	
RM 4			22		24		31
RM 5 LP			29		35	32	
RM 5		9	38		48		61
RM 6 LP			45		56	51	
RM 6		17	64		79		101
RM 7 LP			67		82	75	
RM 7		23	86		107		137
RM 8 LP			97		121	111	
RM 8		35	131		162		207
RM 10 LP			173		214	196	
RM 10		63	234		289		370
RM 12 LP			366		453	416	
RM 12		136	503		622		796
RM 14 LP			611		756	694	
RM 14		229	846		1046		1339
PM 50/39	391				1742		
PM 62/49	673				2999		
PM 74/59	1131				5036		
PM 87/70	1567				6982		
PM 114/93	2963				13196		
EP 5					2.6		
EP 6					2.7		
EP 7					13		
EP 10					25		
EP 13					55		
EP 17					114		
EP 20					329		
P 9 × 5					14		
P 11 × 7					25		
P 14 × 8		12			62		
P 18 × 11					133		
P 22 × 13					232		

Application notes

Power applications

P_{trans} of cores for wound transformers ($f_{Cu} = 0.4$)

	N27	N41	N49	N72	N87	N92	N97
f_{typ} [kHz]	25	25	500	25	100	100	100
P 26 × 16					394		
P 30 × 19					613		
E 5					1.7		
E 6.3					2.4		
E 8.8					5.0		
E 10/5.5/5	14				30		
E 13/7/4	5				28		
E 14/8/4	7	13					
E 16/6/5	9				45		
E 16/8/5	13	13.2			67		
E 19/8/5	16				82		
E 20/10/6	26				118		
E 21/9/5	15						
E 25/13/7	49				218		
E 25.4/10/7	42				189		
E 30/15/7	94				418		
E 32/16/9	118				525		
E 32/16/11					566		
E 34/14/9	118				530		
E 36/18/11	146				652		
E 40/16/12	172			574	768		
E 42/21/15	214				952		
E 42/21/20	289				1290		
E 47/20/16	304				1350		
E 55/28/21	538				2396		
E 55/28/25	763				3400		
E 56/24/19	532				1167		
E 65/32/27	1091				4860		
E 70/33/32	1453				6500		
E 80/38/20	1503				6700		
EEQ 13/2.85			49		43	42	48
EIQ 13/3.85			28		25	24	28
EEQ 20/6.3			212		202	196	220

Application notes

Power applications

P_{trans} of cores for wound transformers ($f_{Cu} = 0.4$)

	N27	N41	N49	N72	N87	N92	N97
f_{typ} [kHz]	25	25	500	25	100	100	100
EIQ 20/8.6			145		137	132	145
EEQ 25/8			294		286	278	310
EIQ 25/7.9			182		175	169	190
EEQ 30/8			503		501	486	540
EIQ 30/10.7			360		351	340	380
ER 9,5					9		
ER 11/5			15		14		
ER 14,5/6			15		12	11	12.5
ER 18/3/10			75		69	66	76
EER 23/5/13			177		167	162	183
EIR 23/7/13			111		105	101	114
ER 25/6/15			247		238	230	258
ER 25/9/15			155		147	143	161
ER 28/17/11				290			
ER 32/5/21			387		381	370	412
ER 35/20/11	309				1388		
ER 42/22/15	384				1725		
ER 46/17/18	376						
ER 49/27/17	636						
ER 54/18/18	482				2168		
ETD 29/16/10	96				428		548
ETD 34/17/11	151				674		863
ETD 39/20/13	230				1023		1309
ETD 44/22/15	383				1708		2186
ETD 49/25/16	594				2645		3385
ETD 54/28/19	897				3998		5116
ETD 59/31/22	1502				6692		8564
EFD 10/5/3			13		12		12.5
EFD 15/8/5			38		42		44
EFD 20/10/7			93		115		119
EFD 25/13/9					245		266
EFD 30/15/9			258		319		345
EV 15/9/7	175				231		252

Application notes

Power applications

P_{trans} of cores for wound transformers ($f_{Cu} = 0.4$)

	N27	N41	N49	N72	N87	N92	N97
f_{typ} [kHz]	25	25	500	25	100	100	100
EV 25/13/13	316				685		750
EV 30/16/13	482				1050		1140
UI 93/104/16	1028				4600		
UU 93/152/16	1413				6350		
UI 93/104/20	1283				5750		
UU 93/152/20	1780				8000		
UI 93/104/30	1784				7950		
UU 93/152/30	2874				12800		
U 101/76/30	4400				19750		
UU 126/182/20					16150		
UI 126/119/20					10850		
U 141/78/30	4300				19300		

Application notes

Power applications

P_{trans} of low-profile cores for planar transformers ($f_{Cu} = 0.1$)

	N 49	N 87	N 92	N 97
RM 4 LP	9.5	10		
RM 5 LP	14	17.5		
RM 6 LP	22	28		
RM 7 LP	33	41		
RM 8 LP	48	60		
RM 10 LP	86	107		
RM 12 LP	183	226		
RM 14 LP	305	378		
ER 9.5		4.5		
ER 11/5	7.5	7		
ER 14.5/6	13	12	11	12
EILP 14	12	11	10	10
EELP 14	16	17	16	16
EILP 18	30	37	34	36
EELP 18	44	55	50	59
EILP 22	78	96	88	105
EELP 22	109	134	123	146
EILP 32	143	177	171	192
EELP 32	203	252	244	274
EILP 38	262	323	313	352
EELP 38	380	470	454	510
EILP 43	360	445	430	482
EELP 43	500	619	599	672
EILP 58		731		
EELP 58		1046		
EILP 64	800	991		
EELP 64	1130	1397		

Application notes

Power applications

6.6 Thermal resistance for the main power transformer core shapes

Core shapes	R _{th} (K/W)	Core shapes	R _{th} (K/W)	Core shapes	R _{th} (K/W)
RM 4	120	E 5	308	ER 9.5	164
RM 4 LP	135	E 6,3	283	ER 11/5	134
RM 5	100	E 8.8	204	ER 14.5/6	99
RM 5 LP	111	E 13/7/4	94	ER 28/17/11	22
RM 6	80	E 14/8/4	79	ER 35/20/11	18
RM 6 LP	90	E 16/6/5	76	ER 42/22/15	14
RM 7	68	E 16/8/5	65	ER 46/17/18	13
RM 7 LP	78	E 19/8/5	60	ER 49/27/17	9
RM 8	57	E 20/10/6	46	ER 54/18/18	11
RM 8 LP	65	E 21/9/5	59		
RM 10	40	E 25/13/7	40	ETD 29/16/10	28
RM 10 LP	45	E 25.4/10/7	41	ETD 34/17/11	20
RM 12	25	E 30/15/7	23	ETD 39/20/13	16
RM 12 LP	29	E 32/16/9	22	ETD 44/22/15	11
RM 14	18	E 32/16/11	21	ETD 49/25/16	8
RM 14 LP	21	E 34/14/9	23	ETD 54/28/19	6
		E 36/18/11	18	ETD 59/31/22	4
PM 50/39	15	E 40/16/12	20		
PM 62/49	12	E 42/21/15	19	EFD 10/5/3	120
PM 74/59	9,5	E 42/21/20	15	EFD 15/8/5	75
PM 87/70	8	E 47/20/16	13	EFD 20/10/7	45
PM 114/93	6	E 55/28/21	11	EFD 25/13/9	30
		E 55/28/25	8	EFD 30/15/9	25
EP 5	329	E 56/24/19	9.5		
EP 6	318	E 65/32/27	6.5	EV 15/9/7	55
EP 7	141	E 70/33/32	5.5	EV 25/13/13	27
EP 10	122	E 80/38/20	7	EV 30/16/13	21
EP 13	82	EI LP 14	116		
EP 17	58	EE LP 14	105	UU 93/152/16	4.5
EP 20	32	EI LP 18	61	UI 93/104/16	5
		EE LP 18	56	UU 93/152/20	4
P 9 × 5	142	EI LP 22	38	UI 93/104/20	4.5
P 11 × 7	106	EE LP 22	35	UU 93/152/30	3
P 14 × 8	73	EI LP 32	26	UI 93/104/30	4
P 18 × 11	51	EE LP 32	24	U 101/76/30	3.3
P 22 × 13	37	EI LP 38	20	U 141/78/30	2.5
P 26 × 16	27	EE LP 38	18		
P 30 × 19	22	EI LP 43	16		
P 36 × 22	17	EE LP 43	15		
		EI LP 58	12		
		EE LP 58	11		
		EI LP 64	9,5		
		EE LP 64	9		