

B-BBOARD
TNP8EB007

<http://www.d43d.ru>

AV2
JK3001
TJSB8007

R OUT
R IN
L OUT
L IN
SLOW SW
S-C IN
VIDEO OUT
VIDEO IN

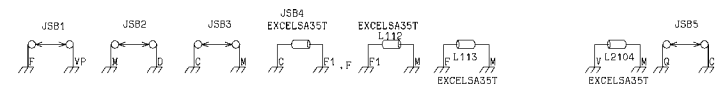

F, P1 GND = IF BLOCK GROUND
V GND = AV TERMINAL GROUND
M GND = SOUND RECORDING BLOCK GROUND
C GND = AV SWITCHING BLOCK AND GENERAL GROUND
D GND = DIGITAL BLOCK GROUND

P-BOARD
TNP8EP013

TO
AC CORD
220-240V
50HZ
BROWN
BLUE

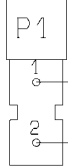

F840
2153.15H

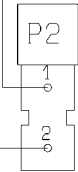
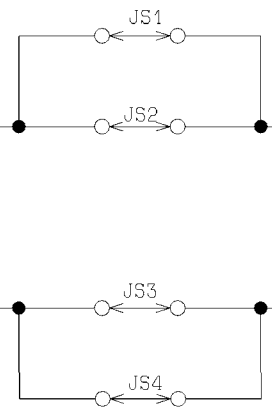
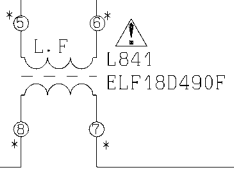
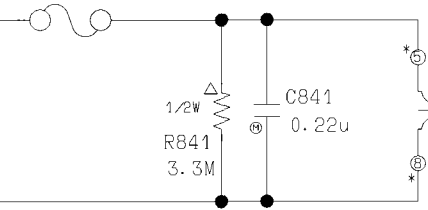

Y-BOARD TX-28MD3P / TX-25MD3P

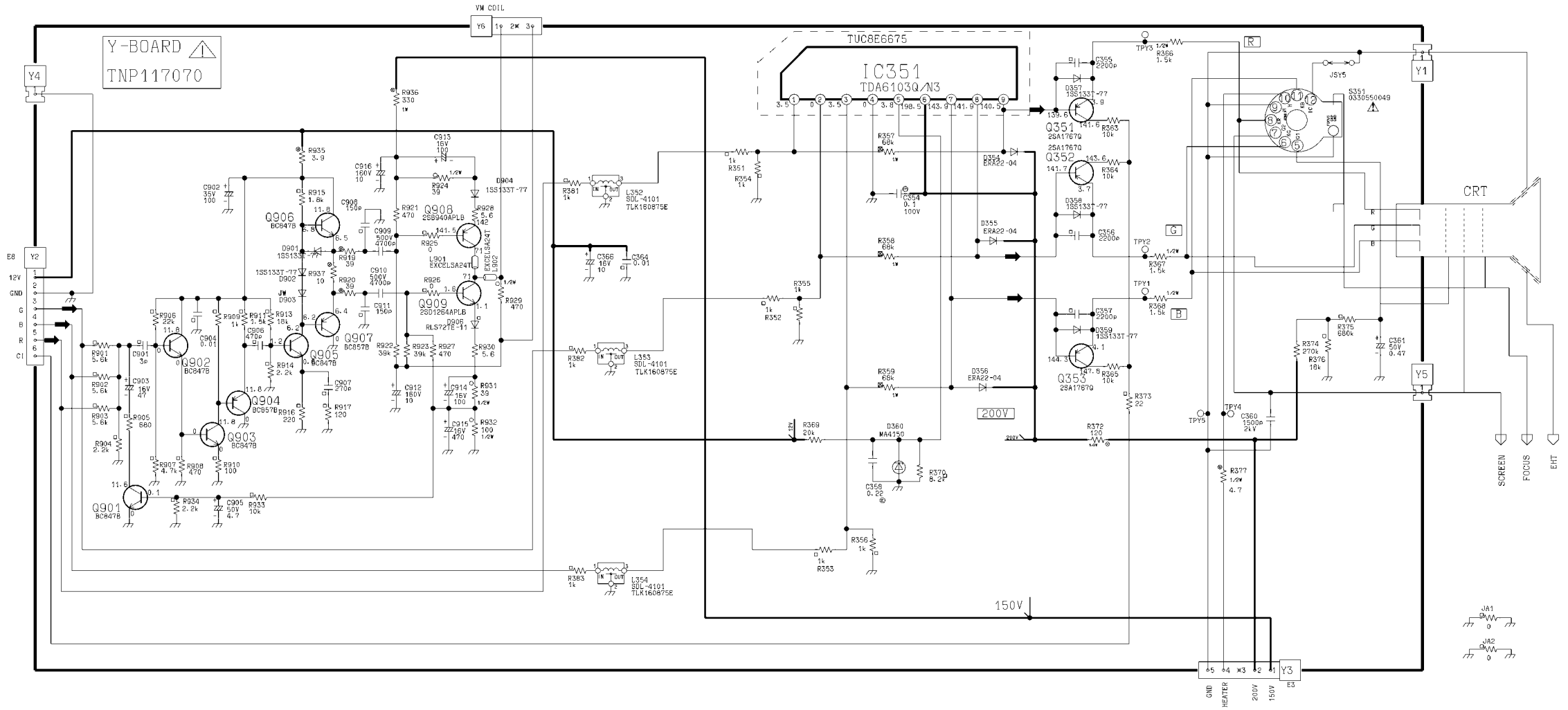

Y-BEARD TX-21MD3P

